

Solution Manual for  
B. P. Lathi  
Signal Processing and Linear Systems

---

Oxford University Press

Oxford University Press

Oxford New York  
Athens Auckland Bangkok Bogotá Buenos Aires Calcutta  
Cape Town Chennai Dar es Salaam Delhi Florence Hong Kong Istanbul  
Karachi Kuala Lumpur Madrid Melbourne Mexico City Mumbai  
Nairobi Paris São Paulo Shanghai Singapore Taipei Tokyo Toronto Warsaw

and associated companies in  
Berlin Ibadan

Copyright © 2001 by Oxford University Press, Inc.

Published by Oxford University Press, Inc.  
198 Madison Avenue, New York, New York, 10016  
<http://www.oup-usa.org>

Oxford is a registered trademark of Oxford University Press

All rights reserved. No part of this publication may be reproduced,  
stored in a retrieval system, or transmitted, in any form or by any means,  
electronic, mechanical, photocopying, recording, or otherwise,  
without the prior permission of Oxford University Press.

**Library of Congress Cataloging-in-Publication Data**

ISBN 0-19-

Printing number: 9 8 7 6 5 4 3 2 1

Printed in the United States of America  
on acid-free paper

# Chapter 1

---

1.1-1 For parts (a) and (b)

$$E_f = \int_0^{2\pi} \sin^2 t \, dt = \frac{1}{2} \int_0^{2\pi} dt - \frac{1}{2} \int_0^{2\pi} \cos 2t \, dt = \pi + 0 = \pi$$

$$(c) \quad E_f = \int_{2\pi}^{4\pi} \sin^2 t \, dt = \frac{1}{2} \int_{2\pi}^{4\pi} dt - \frac{1}{2} \int_{2\pi}^{4\pi} \cos 2t \, dt = \pi + 0 = \pi$$

$$(d) \quad E_f = \int_0^{2\pi} (2 \sin t)^2 \, dt = 4 \left[ \frac{1}{2} \int_0^{2\pi} dt - \frac{1}{2} \int_0^{2\pi} \cos 2t \, dt \right] = 4[\pi + 0] = 4\pi$$

1.1-2

$$E_{f_1} = \int_0^1 t^2 \, dt = \frac{1}{3} t^3 \Big|_0^1 = \frac{1}{3}, \quad E_{f_2} = \int_{-1}^0 (-t)^2 \, dt = \frac{1}{3} t^3 \Big|_{-1}^0 = \frac{1}{3}$$

$$E_{f_3} = \int_0^1 (-t)^2 \, dt = \frac{1}{3} t^3 \Big|_0^1 = \frac{1}{3}, \quad E_{f_4} = \int_1^2 (t-1)^2 \, dt = \int_0^1 x^2 \, dx = \frac{1}{3}$$

$$E_{f_5} = \int_0^1 (2t)^2 \, dt = \frac{4}{3} t^3 \Big|_0^1 = \frac{4}{3}$$

1.1-3 (a)  $E_x = \int_0^2 (1)^2 \, dt = 2, \quad E_y = \int_0^1 (1)^2 \, dt + \int_1^2 (-1)^2 \, dt = 2$

$$E_{x+y} = \int_0^1 (2)^2 \, dt = 4, \quad E_{x-y} = \int_1^2 (2)^2 \, dt = 4$$

Therefore  $E_{x\pm y} = E_x + E_y$ .

$$(b) \quad E_x = \int_0^\pi (1)^2 \, dt + \int_\pi^{2\pi} (-1)^2 \, dt = 2\pi, \quad E_y = \int_0^{\pi/2} (1)^2 \, dt + \int_{\pi/2}^\pi (-1)^2 \, dt + \int_\pi^{3\pi/2} (1)^2 \, dt + \int_{3\pi/2}^{2\pi} (-1)^2 \, dt = 2\pi$$

$$E_{x+y} = \int_0^{\pi/2} (2)^2 \, dt + \int_{\pi/2}^{3\pi/2} (0)^2 \, dt + \int_{3\pi/2}^{2\pi} (-1)^2 \, dt = 4\pi$$

Similarly, we can show that  $E_{x-y} = 4\pi$ . Therefore  $E_{x\pm y} = E_x + E_y$ .

$$(c) \quad E_x = \int_0^{\pi/4} (1)^2 \, dt + \int_{\pi/4}^\pi (-1)^2 \, dt = \pi, \quad E_y = \int_0^\pi (1)^2 \, dt = \pi$$

$$E_{x+y} = \int_0^{\pi/4} (2)^2 \, dt + \int_{\pi/4}^\pi (0)^2 \, dt = \pi, \quad E_{x-y} = \int_0^{\pi/4} (0)^2 \, dt + \int_{\pi/4}^\pi (-2)^2 \, dt = 3\pi$$

Therefore, in general  $E_{x\pm y} \neq E_x + E_y$

1.1-4

$$P_f = \frac{1}{4} \int_{-2}^2 (t^3)^2 \, dt = 64/7 \quad (a) \quad P_{-f} = \frac{1}{4} \int_{-2}^2 (-t^3)^2 \, dt = 64/7$$

$$(b) \quad P_{2f} = \frac{1}{4} \int_{-2}^2 (2t^3)^2 \, dt = 4(64/7) = 256/7 \quad (c) \quad P_{cf} = \frac{1}{4} \int_{-2}^2 (ct^3)^2 \, dt = 64c^2/7$$

Sign change of a signal does not affect its power. Multiplication of a signal by a constant  $c$  increases the power by a factor  $c^2$ .

1.1-5

$$P_f = \lim_{T \rightarrow \infty} \frac{1}{T} \int_{-T/2}^{T/2} f(t) f^*(t) dt = \lim_{T \rightarrow \infty} \frac{1}{T} \int_{-T/2}^{T/2} \sum_{k=m}^n \sum_{r=m}^n D_k D_r^* e^{j(\omega_k - \omega_r)t} dt$$

The integrals of the cross-product terms (when  $k \neq r$ ) are finite because the integrands are periodic signals (made up of sinusoids). These terms, when divided by  $T \rightarrow \infty$ , yield zero. The remaining terms ( $k = r$ ) yield

$$P_f = \lim_{T \rightarrow \infty} \frac{1}{T} \int_{-T/2}^{T/2} \sum_{k=m}^n |D_k|^2 dt = \sum_{k=m}^n |D_k|^2$$

1.1-6 (a) Power of a sinusoid of amplitude  $C$  is  $C^2/2$  [Eq. (1.5a)] regardless of its frequency ( $\omega \neq 0$ ) and phase. Therefore, in this case  $P = (10)^2/2 = 50$ .

(b) Power of a sum of sinusoids is equal to the sum of the powers of the sinusoids [Eq. (1.5b)]. Therefore, in this case  $P = \frac{(10)^2}{2} + \frac{(16)^2}{2} = 178$ .

(c)  $(10 + 2 \sin 3t) \cos 10t = 10 \cos 10t + \sin 13t - \sin 3t$ . Hence from Eq. (1.5b)  $P = \frac{(10)^2}{2} + \frac{1}{2} + \frac{1}{2} = 51$ .

(d)  $10 \cos 5t \cos 10t = 5(\cos 5t + \cos 15t)$ . Hence from Eq. (1.5b)  $P = \frac{(5)^2}{2} + \frac{(5)^2}{2} = 25$ .

(e)  $10 \sin 5t \cos 10t = 5(\sin 15t - \sin 5t)$ . Hence from Eq. (1.5b)  $P = \frac{(5)^2}{2} + \frac{(-5)^2}{2} = 25$ .

(f)  $e^{j\alpha t} \cos \omega_0 t = \frac{1}{2} [e^{j(\alpha + \omega_0)t} + e^{j(\alpha - \omega_0)t}]$ . Using the result in Prob. 1.1-5, we obtain  $P = (1/4) + (1/4) = 1/2$ .

1.3-1

$$f_2(t) = f(t-1) + f_1(t-1) \quad f_3(t) = f(t-1) + f_1(t+1) \quad f_4(t) = f(t-0.5) + f_1(t+0.5)$$

The signal  $f_5(t)$  can be obtained by (i) delaying  $f(t)$  by 1 second (replace  $t$  with  $t-1$ ), (ii) then time-expanding by a factor 2 (replace  $t$  with  $t/2$ ), (iii) then multiply with 1.5. Thus  $f_5(t) = 1.5f(\frac{t}{2}-1)$ .

1.3-2 All the signals are shown in Fig. S1.3-2.

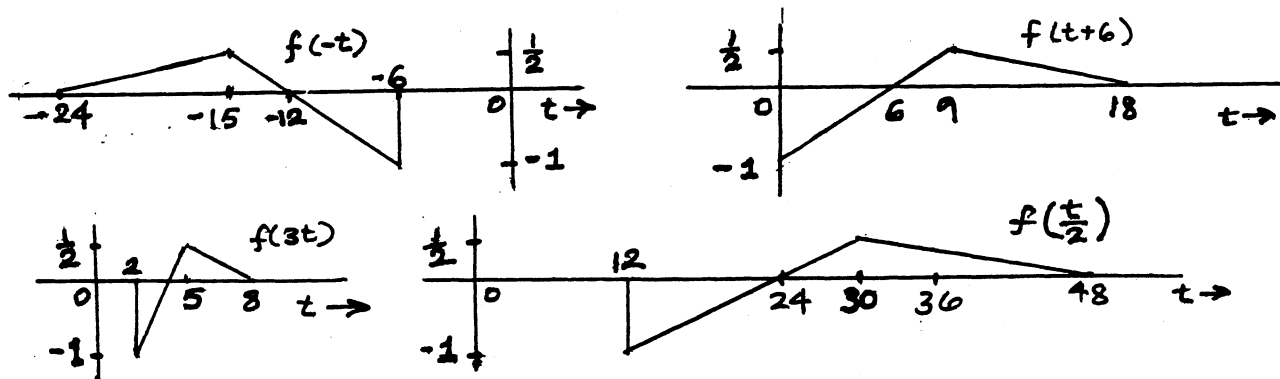

Fig. S1.3-2

1.3-3 All the signals are shown in Fig. S1.3-3

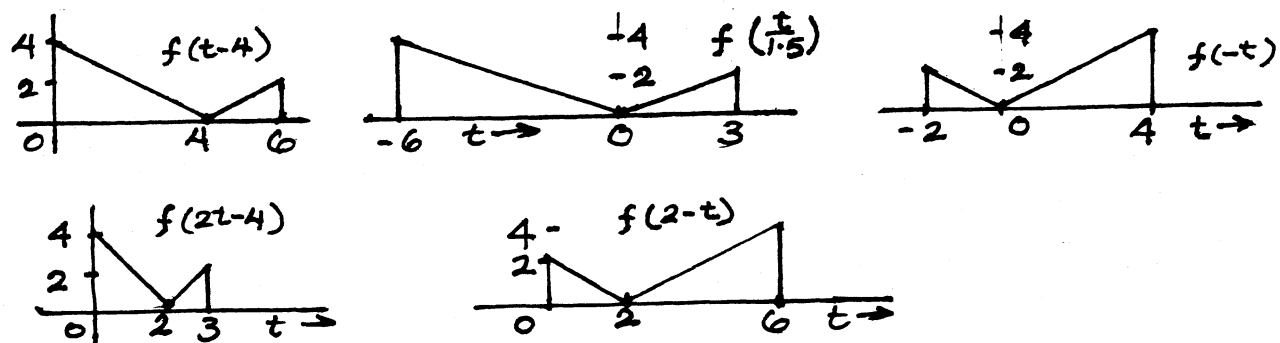

Fig. S1.3-3

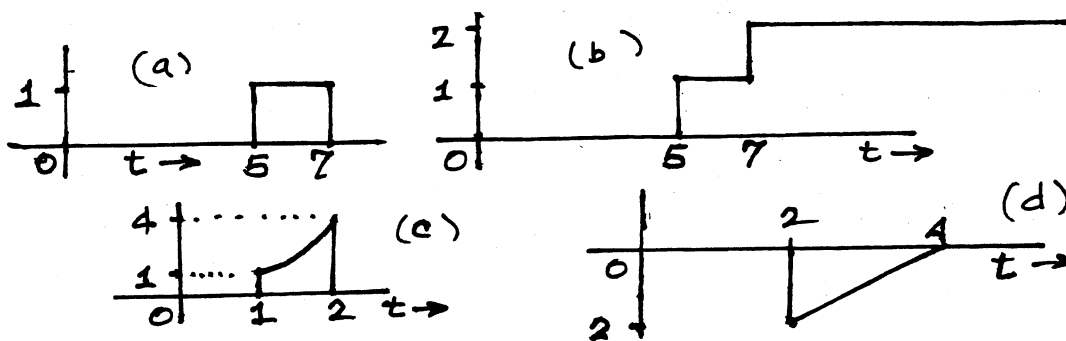

Fig. S1.4-1

1.4-1 All the signals are shown in Fig. S1.4-1.

1.4-2

$$f_1(t) = 4(t+1)[u(t+1) - u(t)] + (-2t+4)[u(t) - u(t-2)] = 4(t+1)u(t+1) - 6tu(t) + 3u(t) + (2t-4)u(t-2)$$

$$f_2(t) = t^2[u(t) - u(t-2)] + (2t-8)[u(t-2) - u(t-4)] = t^2u(t) - (t^2 - 2t + 8)u(t-2) - (2t-8)u(t-4)$$

1.4-3

$$E_{-f} = \int_{-\infty}^{\infty} [-f(t)]^2 dt = \int_{-\infty}^{\infty} f^2(t) dt = E_f, \quad E_{f(-t)} = \int_{-\infty}^{\infty} [f(-t)]^2 dt = \int_{-\infty}^{\infty} f^2(x) dx = E_f$$

$$E_{f(t-T)} = \int_{-\infty}^{\infty} [f(t-T)]^2 dt = \int_{-\infty}^{\infty} f^2(x) dx = E_f, \quad E_{f(at)} = \int_{-\infty}^{\infty} [f(at)]^2 dt = \frac{1}{a} \int_{-\infty}^{\infty} f^2(x) dx = E_f/a$$

$$E_{f(at-b)} = \int_{-\infty}^{\infty} [f(at-b)]^2 dt = \frac{1}{a} \int_{-\infty}^{\infty} f^2(x) dx = E_f/a, \quad E_{f(t/a)} = \int_{-\infty}^{\infty} [f(t/a)]^2 dt = a \int_{-\infty}^{\infty} f^2(x) dt = aE_f$$

$$E_{af(t)} = \int_{-\infty}^{\infty} [af(t)]^2 dt = a^2 \int_{-\infty}^{\infty} f^2(t) dt = a^2 E_f$$

1.4-4 Using the fact that  $f(x)\delta(x) = f(0)\delta(x)$ , we have

(a) 0 (b)  $\frac{2}{9}\delta(\omega)$  (c)  $\frac{1}{2}\delta(t)$  (d)  $-\frac{1}{5}\delta(t-1)$  (e)  $\frac{1}{2-j3}\delta(\omega+3)$  (f)  $k\delta(\omega)$  (use L' Hôpital's rule)

1.4-5 In these problems remember that impulse  $\delta(x)$  is located at  $x=0$ . Thus, an impulse  $\delta(t-\tau)$  is located at  $\tau=t$ , and so on.

(a) The impulse is located at  $\tau=t$  and  $f(\tau)$  at  $\tau=t$  is  $f(t)$ . Therefore

$$\int_{-\infty}^{\infty} f(\tau)\delta(t-\tau) d\tau = f(t)$$

(b) The impulse  $\delta(\tau)$  is at  $\tau=0$  and  $f(t-\tau)$  at  $\tau=0$  is  $f(t)$ . Therefore

$$\int_{-\infty}^{\infty} \delta(\tau)f(t-\tau) d\tau = f(t)$$

Using similar arguments, we obtain

(c) 1 (d) 0 (e)  $e^3$  (f) 5 (g)  $f(-1)$  (h)  $-e^2$

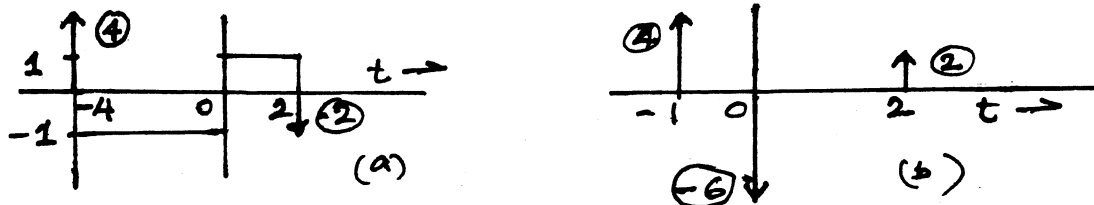

Fig. S1.4-6

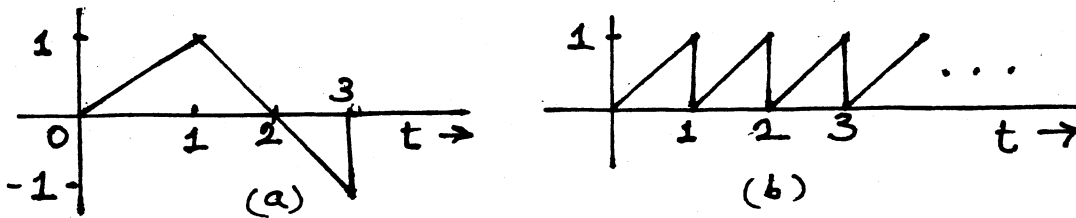

Fig. S1.4-7

1.4-6 (a) Recall that the derivative of a function at the jump discontinuity is equal to an impulse of strength equal to the amount of discontinuity. Hence,  $df/dt$  contains impulses  $\delta(t+4)$  and  $2\delta(t-2)$ . In addition, the derivative is  $-1$  over the interval  $(-4, 0)$ , and is  $1$  over the interval  $(0, 2)$ . The derivative is zero for  $t < -4$  and  $t > 2$ . The result is sketched in Fig. S1.4-6a.

(b) Using the procedure in part (a), we find  $d^2f/dt^2$  for the signal in Fig. P1.4-2a as shown in Fig. S1.4-6b.

1.4-7 (a) Recall that the area under an impulse of strength  $k$  is  $k$ . Over the interval  $0 \leq t \leq 1$ , we have

$$y(t) = \int_0^t 1 \, dx = t \quad 0 \leq t \leq 1$$

Over the interval  $0 \leq t < 3$ , we have

$$y(t) = \int_0^1 1 \, dx + \int_1^t (-1) \, dx = 2 - t \quad 1 \leq t < 3$$

At  $t = 3$ , the impulse (of strength unity) yields an additional term of unity. Thus,

$$y(t) = \int_0^1 1 \, dx + \int_1^3 (-1) \, dx + \int_{3-\epsilon}^t \delta(x-3) \, dx = 1 + (-2) + 1 = 0 \quad t > 3$$

(b)

$$y(t) = \int_0^t [1 - \delta(x-1) - \delta(x-2) - \delta(x-3) + \dots] \, dx = tu(t) - u(t-1) - u(t-2) - u(t-3) - \dots$$

1.4-8 Changing the variable  $t$  to  $-x$ , we obtain

$$\int_{-\infty}^{\infty} \phi(t)\delta(-t) \, dt = - \int_{\infty}^{-\infty} \phi(-x)\delta(x) \, dx = \int_{-\infty}^{\infty} \phi(-x)\delta(x) \, dx = \phi(0)$$

This shows that

$$\int_{-\infty}^{\infty} \phi(t)\delta(t) \, dt = \int_{-\infty}^{\infty} \phi(t)\delta(-t) \, dt = \phi(0)$$

Therefore

$$\delta(t) = \delta(-t)$$

1.4-9 Letting  $at = x$ , we obtain (for  $a > 0$ )

$$\int_{-\infty}^{\infty} \phi(t)\delta(at) \, dt = \frac{1}{a} \int_{-\infty}^{\infty} \phi\left(\frac{x}{a}\right)\delta(x) \, dx = \frac{1}{a} \phi(0)$$

Similarly for  $a < 0$ , we show that this integral is  $-\frac{1}{a}\phi(0)$ . Therefore

$$\int_{-\infty}^{\infty} \phi(t)\delta(at) \, dt = \frac{1}{|a|} \phi(0) = \frac{1}{|a|} \int_{-\infty}^{\infty} \phi(t)\delta(t) \, dt$$

Therefore

$$\delta(at) = \frac{1}{|a|} \delta(t)$$

1.4-10 (a)

$$\int_{-\infty}^{\infty} \delta(t)\phi(t) dt = \phi(t)\delta(t)|_{-\infty}^{\infty} - \int_{-\infty}^{\infty} \dot{\phi}(t)\delta(t) dt$$

$$= 0 - \int \dot{\phi}(t)\delta(t) dt = -\dot{\phi}(0)$$

1.4-11 (a)  $s_{1,2} = \pm j3$  (b)  $e^{-3t} \cos 3t = 0.5[e^{-(3+j3)t} + e^{-(3-j3)t}]$ . Therefore the frequencies are  $s_{1,2} = -3 \pm j3$  (c) Using the argument in (b), we find the frequencies  $s_{1,2} = 2 \pm j3$  (d)  $s = -2$  (e)  $s = 2$  (f)  $5 = 5e0t$  so that  $s = 0$ .

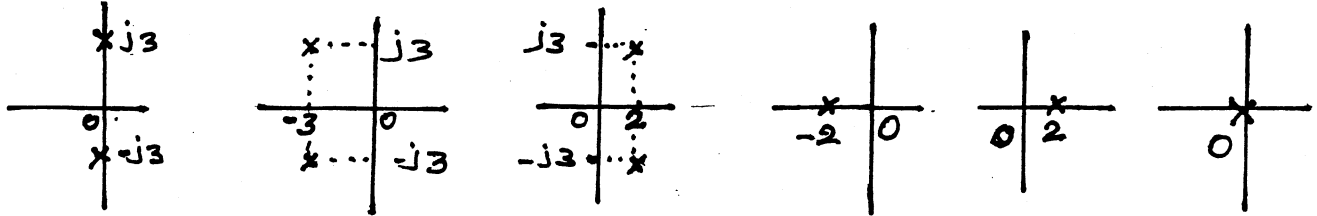

Fig. S1.4-11

- 1.5-1 (a)  $f_e(t) = 0.5[u(t) + u(-t)] = 0.5$  and  $f_o(t) = 0.5[u(t) - u(-t)]$ .  
 (b)  $f_e(t) = 0.5[tu(t) - tu(-t)] = 0.5|t|$  and  $f_o(t) = 0.5[tu(t) + tu(-t)] = 0.5t$ .  
 (c)  $f_e(t) = 0.5[\sin \omega_0 t u(t) + \sin(-\omega_0 t)u(-t)] = 0.5[\sin \omega_0 t u(t) - \sin \omega_0 t u(-t)]$   
 and  $f_o(t) = 0.5[\sin \omega_0 t u(t) - \sin(-\omega_0 t)u(-t)] = 0.5[\sin \omega_0 t u(t) + \sin \omega_0 t u(-t)] = 0.5 \sin \omega_0 t$ .  
 (d)  $f_e(t) = 0.5[\cos \omega_0 t u(t) + \cos(-\omega_0 t)u(-t)] = 0.5[\cos \omega_0 t u(t) + \cos \omega_0 t u(-t)] = 0.5 \cos \omega_0 t$   
 and  $f_o(t) = 0.5[\cos \omega_0 t u(t) - \cos(-\omega_0 t)u(-t)] = 0.5[\cos \omega_0 t u(t) - \cos \omega_0 t u(-t)]$ .  
 (e)  $f_e(t) = 0.5[\sin \omega_0 t + \sin(-\omega_0 t)] = 0$  and  $f_o(t) = 0.5[\sin \omega_0 t - \sin(-\omega_0 t)] = \sin \omega_0 t$   
 (f)  $f_e(t) = 0.5[\cos \omega_0 t + \cos(-\omega_0 t)] = \cos \omega_0 t$  and  $f_o(t) = 0.5[\cos \omega_0 t - \cos(-\omega_0 t)] = 0$

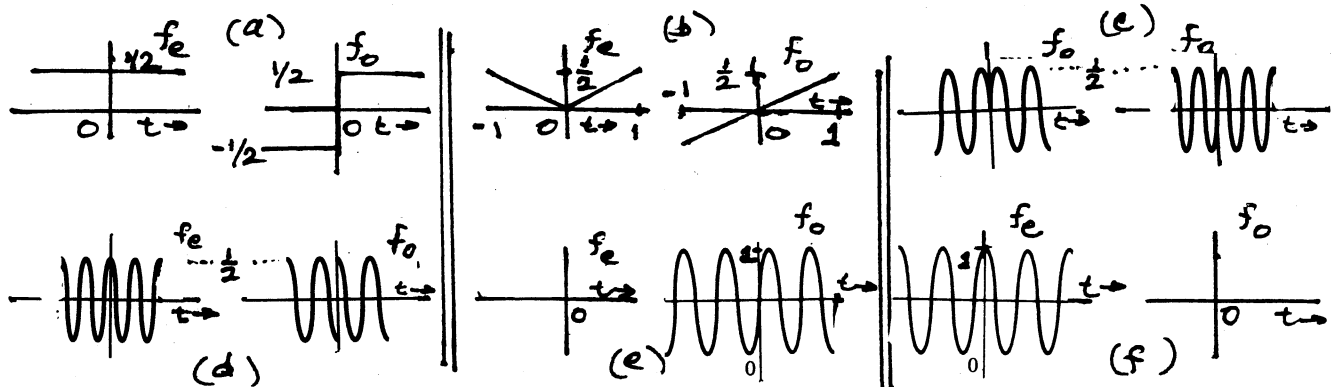

Fig. S1.5-1

1.6-1 If  $f(t)$  and  $y(t)$  are the input and output, respectively, of an ideal integrator, then

$$y(t) = f(t)$$

and

$$y(t) = \int_{-\infty}^t f(\tau) d\tau = \int_{-\infty}^0 f(\tau) d\tau + \int_0^t f(\tau) d\tau = \underbrace{y(0)}_{\text{zero-input}} + \underbrace{\int_0^t f(\tau) d\tau}_{\text{zero-state}}$$

(g)

1.7-1 Only (b) and (h) are linear. All the remaining are nonlinear. This can be verified by using the procedure discussed in Example 1.10.

1.7-2 (a) The system is time-invariant because the input  $f(t)$  yields the output  $y(t) = f(t - 2)$ . Hence, if the input is  $f(t - T)$ , the output is  $f(t - T - 2) = y(t - T)$ , which makes the system time-invariant.

(b) The system is time-varying. The input  $f(t)$  yields the output  $y(t) = f(-t)$ . Thus, the output is obtained by changing the sign of  $t$  in  $f(t)$ . Therefore, when the input is  $f(t - T)$ , the output is  $f(-t - T) = f(-(t + T)) = y(t + T)$ , which represents the original output advanced by  $T$  (not delayed by  $T$ ).

(c) The system is time-varying. The input  $f(t)$  yields the output  $y(t) = f(at)$ , which is a scaled version of the input. Thus, the output is obtained by replacing  $t$  in the input with  $at$ . Thus, if the input is  $f(t - T)$  ( $f(t)$  delayed by  $T$ ), the output is  $f(at - T) = f(a[t - \frac{T}{a}])$ , which is  $f(at)$  delayed by  $T/a$  (not  $T$ ). Hence the system is time-varying.

(d) The system is time-varying. The input  $f(t)$  yields the output  $y(t) = tf(t)$ . For the input  $f(t - T)$ , the output is  $t f(t - T)$ , which is not  $t f(t)$  delayed by  $T$ . Hence the system is time-varying.

(e) The system is time-varying. The output is a constant, given by the area under  $f(t)$  over the interval  $|t| \leq 5$ . Now, if  $f(t)$  is delayed by  $T$ , the output, which is the area under the delayed  $f(t)$ , is another constant. But this output is not the same as the original output delayed by  $T$ . Hence the system is time-varying.

(f) The system is time-invariant. The input  $f(t)$  yields the output  $y(t)$ , which is the square of the second derivative of  $f(t)$ . If the input is delayed by  $T$ , the output is also delayed by  $T$ . Hence the system is time-invariant.

1.7-3 We construct the table below from the first three rows of data. Because of the linearity property of the system, we can multiply any row by a constant. We can also add (or subtract) any two rows. Let  $r_j$  denote the  $j$ th row.

Row	$f(t)$	$x_1(0)$	$x_2(0)$	$y(t)$
$r_1$	0	1	-1	$e^{-t}u(t)$
$r_2$	0	2	1	$e^{-t}(3t + 2)u(t)$
$r_3$	$u(t)$	-1	-1	$2u(t)$
$r_4 = \frac{1}{3}(r_1 + r_2)$	0	1	0	$(t + 1)e^{-t}u(t)$
$r_5 = \frac{1}{2}(r_1 + r_3)$	$\frac{1}{2}u(t)$	0	-1	$(\frac{1}{2}e^{-t} + 1)u(t)$
$r_6 = (r_4 + r_5)$	$\frac{1}{2}u(t)$	1	-1	$(1.5e^{-t} + te^{-t} + 1)u(t)$
$r_7 = 2(r_6 + r_1)$	$u(t)$	0	0	$(e^{-t} + 2te^{-t} + 2)u(t)$

In our case, the input  $f(t) = u(t + 5) - u(t - 5)$ . From  $r_7$  and the superposition and time-invariance property, we have

$$y(t) = r_7(t + 5) - r_7(t - 5) \\ = [e^{-(t+5)} + 2(t + 5)e^{-(t+5)} + 2] u(t + 5) - [e^{-(t-5)} + 2(t - 5)e^{-(t-5)} + 2] u(t - 5)$$

1.7-4 If the input is  $kf(t)$ , the new output  $y(t)$  is

$$y(t) = (kf)^2 / (k \frac{df}{dt}) = k [f^2(t) / (\frac{df}{dt})]$$

Hence the homogeneity is satisfied. Also

$$f_1 \rightarrow y_1 = (f_1)^2 / (\dot{f}_1) \quad \text{and} \quad f_2 \rightarrow y_2 = (f_2)^2 / (\dot{f}_2)$$

$$\text{But } f_1 + f_2 \rightarrow (f_1 + f_2)^2 / (\dot{f}_1 + \dot{f}_2) \neq y_1 + y_2$$

1.7-5 From the hint it is clear that when  $v_c(0) = 0$ , the capacitor may be removed, and the circuit behaves as shown in Fig. S1.7-5. It is clearly zero-state linear. To show that it is zero-input nonlinear, consider the circuit with  $f(t) = 0$  (zero-input). The current  $y(t)$  has the same direction (shown by arrow) regardless of the polarity of  $v_c$  (because the input branch is a short). Thus the system is zero-input nonlinear.

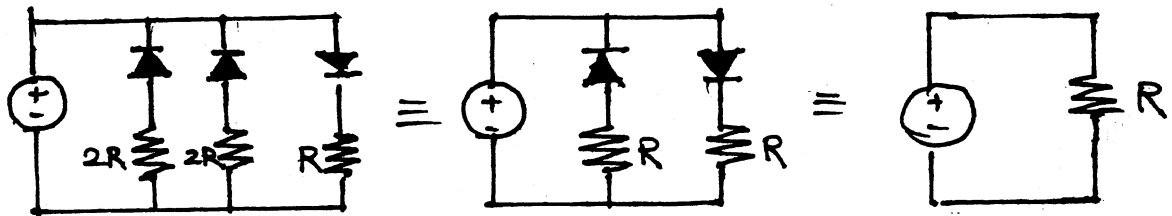

Figure S1.7-5



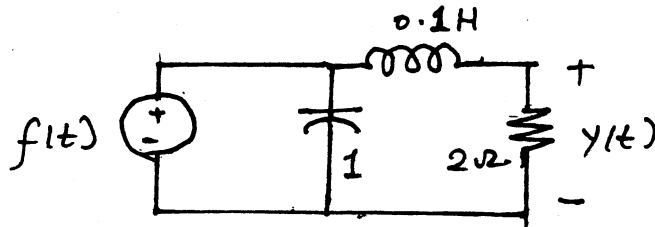

Figure S1.7-6

1.7-6 The solution is trivial. The input is a current source. Hence, as far as the output  $y(t)$  is concerned, the circuit behaves as shown in Fig. S1.7-6. The nonlinear elements are irrelevant in computing the output  $y(t)$ . Hence the output  $y(t)$  satisfies the linearity conditions. Yet, the circuit is nonlinear because it contains nonlinear elements and the outputs associated with nonlinear elements  $L$  and  $C$  will not satisfy linearity conditions.

1.7-7 (a)  $y(t) = f(t - 2)$ . Thus, the output  $y(t)$  always starts after the input by 2 seconds (see Fig. S1.7-7a). Clearly, the system is causal.

(b)  $y(t) = f(-t)$ . The output  $y(t)$  is obtained by time inversion in the input. Thus, if the input starts at  $t = 0$ , the output starts before  $t = 0$  (see Fig. S1.7-7b). Hence, the system is not causal.

(c)  $y(t) = f(at)$ ,  $a > 1$ . The output  $y(t)$  is obtained by time compression of the input by factor  $a$ . Hence, the output can start before the input (see Fig. S1.7-7c), and the system is not causal.

(d)  $y(t) = f(at)$ ,  $a < 1$ . The output  $y(t)$  is obtained by time expansion of the input by factor  $1/a$ . Hence, the output can start before the input (see Fig. S1.7-7d), and the system is not causal.

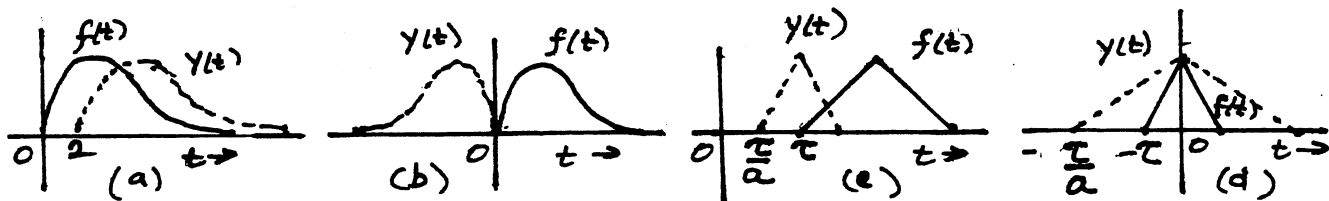

Figure S1.7-7

1.7-8 (a) Invertible because the input can be obtained by taking the derivative of the output. Hence, the inverse system equation is  $y(t) = df/dt$ .

(b) The system  $y(t) = f(3t - 6) = f(3[t - 2])$  represents an operation of signal compression by factor 3, and then time delay by 2 seconds. Hence, the input can be obtained from the output by first advancing the output by 2 seconds, and then time-expanding by factor 3. Hence, the inverse system equation is  $y(t) = f(\frac{t}{3} + 2)$ . Although the system is invertible, it is not realizable because it involves the operation of signal compression and signal advancing (which makes it noncausal). However, if we can accept time delay, we can realize a noncausal system.

(c) Not invertible for even values of  $n$ , because the sign information is lost. However, the system is invertible for odd values of  $n$ . The inverse system equation is  $y(t) = [f(t)]^{1/n}$ .

(d) Not invertible because cosine is a multiple valued function, and  $\cos^{-1}[f(t)]$  is not unique.

1.8-1 The loop equation for the circuit is

$$3y_1(t) + Dy_1(t) = f(t) \quad \text{or} \quad (D + 3)y_1(t) = f(t) \quad (1)$$

Also

$$Dy_1(t) = y_2(t) \implies y_1(t) = \frac{1}{D}y_2(t) \quad (2)$$

Substitution of (2) in (1) yields

$$\frac{(D + 3)}{D}y_2(t) = f(t) \quad \text{or} \quad (D + 3)y_2(t) = Df(t) \quad (3)$$

1.8-2 The currents in the resistor, capacitor and inductor are  $2y_2(t)$ ,  $Dy_2(t)$  and  $(2/D)y_2(t)$ , respectively. Therefore

$$(D + 2 + \frac{2}{D})y_2(t) = f(t)$$

or

$$(D^2 + 2D + 2)y_2(t) = Df(t) \quad (1)$$

Also

$$y_1(t) = Dy_2(t) \quad \text{or} \quad y_2(t) = \frac{1}{D}y_1(t) \quad (2)$$

Substituting of (2) in (1) yields

$$\frac{D^2 + 2D + 2}{D}y_1(t) = Df(t)$$

or

$$(D^2 + 2D + 2)y_1(t) = D^2f(t) \quad (3)$$

**1.8-3**

$$[q_i(t) - q_0(t)]\Delta t = A\Delta h$$

or

$$\dot{h}(t) = \frac{1}{A}[q_i(t) - q_0(t)] \quad (1)$$

But

$$q_0(t) = Rh(t) \quad (2)$$

Differentiation of (2) yields

$$\dot{q}_0(t) = R\dot{h}(t) = \frac{R}{A}[q_i(t) - q_0(t)]$$

and

$$\left(D + \frac{R}{A}\right)q_0(t) = \frac{R}{A}q_i(t)$$

or

$$(D + a)q_0(t) = aq_i(t) \quad a = \frac{R}{A} \quad (3)$$

and

$$q_0(t) = \frac{a}{D + a}q_i(t)$$

substituting this in (1) yields

$$\dot{h}(t) = \frac{1}{A}\left(1 - \frac{a}{D + a}\right)q_i(t) = \frac{D}{A(D + a)}q_i(t)$$

or

$$(D + a)h(t) = \frac{1}{A}q_i(t) \quad (4)$$

## Chapter 2

---

**2.2-1** The characteristic polynomial is  $\lambda^2 + 5\lambda + 6$ . The characteristic equation is  $\lambda^2 + 5\lambda + 6 = 0$ . Also  $\lambda^2 + 5\lambda + 6 = (\lambda + 2)(\lambda + 3)$ . Therefore the characteristic roots are  $\lambda_1 = -2$  and  $\lambda_2 = -3$ . The characteristic modes are  $e^{-2t}$  and  $e^{-3t}$ . Therefore

$$y_0(t) = c_1 e^{-2t} + c_2 e^{-3t}$$

and

$$\dot{y}_0(t) = -2c_1 e^{-2t} - 3c_2 e^{-3t}$$

Setting  $t = 0$ , and substituting initial conditions  $y_0(0) = 2$ ,  $\dot{y}_0(0) = -1$  in this equation yields

$$\left. \begin{array}{l} c_1 + c_2 = 2 \\ -2c_1 - 3c_2 = -1 \end{array} \right\} \Rightarrow \begin{array}{l} c_1 = 5 \\ c_2 = -3 \end{array}$$

Therefore

$$y_0(t) = 5e^{-2t} - 3e^{-3t}$$

**2.2-2** The characteristic polynomial is  $\lambda^2 + 4\lambda + 4$ . The characteristic equation is  $\lambda^2 + 4\lambda + 4 = 0$ . Also  $\lambda^2 + 4\lambda + 4 = (\lambda + 2)^2$ , so that the characteristic roots are  $-2$  and  $-2$  (repeated twice). The characteristic modes are  $e^{-2t}$  and  $te^{-2t}$ . Therefore

$$y_0(t) = c_1 e^{-2t} + c_2 t e^{-2t}$$

and

$$\dot{y}_0(t) = -2c_1 e^{-2t} - 2c_2 t e^{-2t} + c_2 e^{-2t}$$

Setting  $t = 0$  and substituting initial conditions yields

$$\left. \begin{array}{l} 3 = c_1 \\ -4 = -2c_1 + c_2 \end{array} \right\} \Rightarrow \begin{array}{l} c_1 = 3 \\ c_2 = 2 \end{array}$$

Therefore

$$y_0(t) = (3 + 2t)e^{-2t}$$

**2.2-3** The characteristic polynomial is  $\lambda(\lambda + 1) = \lambda^2 + \lambda$ . The characteristic equation is  $\lambda(\lambda + 1) = 0$ . The characteristic roots are  $0$  and  $-1$ . The characteristic modes are  $1$  and  $e^{-t}$ . Therefore

$$y_0(t) = c_1 + c_2 e^{-t}$$

and

$$\dot{y}_0(t) = -c_2 e^{-t}$$

Setting  $t = 0$ , and substituting initial conditions yields

$$\left. \begin{array}{l} 1 = c_1 + c_2 \\ 1 = -c_2 \end{array} \right\} \Rightarrow \begin{array}{l} c_1 = 2 \\ c_2 = -1 \end{array}$$

Therefore

$$y_0(t) = 2 - e^{-t}$$

**2.2-4** The characteristic polynomial is  $\lambda^2 + 9$ . The characteristic equation is  $\lambda^2 + 9 = 0$  or  $(\lambda + j3)(\lambda - j3) = 0$ . The characteristic roots are  $\pm j3$ . The characteristic modes are  $e^{j3t}$  and  $e^{-j3t}$ . Therefore

$$y_0(t) = c \cos(3t + \theta)$$

and

$$\dot{y}_0(t) = -3c \sin(3t + \theta)$$

Setting  $t = 0$ , and substituting initial conditions yields

$$\left. \begin{array}{l} 0 = c \cos \theta \\ 6 = -3c \sin \theta \end{array} \right\} \Rightarrow \left. \begin{array}{l} c \cos \theta = 0 \\ c \sin \theta = -2 \end{array} \right\} \Rightarrow \begin{array}{l} c = 2 \\ \theta = -\pi/2 \end{array}$$

Therefore

$$y_0(t) = 2 \cos(3t - \frac{\pi}{2}) = 2 \sin 3t$$

2.2-5 The characteristic polynomial is  $\lambda^2 + 4\lambda + 13$ . The characteristic equation is  $\lambda^2 + 4\lambda + 13 = 0$  or  $(\lambda + 2 - j3)(\lambda + 2 + j3) = 0$ . The characteristic roots are  $-2 \pm j3$ . The characteristic modes are  $c_1 e^{(-2+j3)t}$  and  $c_2 e^{(-2-j3)t}$ . Therefore

$$y_0(t) = c e^{-2t} \cos(3t + \theta)$$

and

$$\dot{y}_0(t) = -2c e^{-2t} \cos(3t + \theta) - 3c e^{-2t} \sin(3t + \theta)$$

Setting  $t = 0$ , and substituting initial conditions yields

$$\left. \begin{array}{l} 5 = c \cos \theta \\ 15.98 = -2c \cos \theta - 3c \sin \theta \end{array} \right\} \Rightarrow \left. \begin{array}{l} c \cos \theta = 5 \\ c \sin \theta = -8.66 \end{array} \right\} \Rightarrow \begin{array}{l} c = 10 \\ \theta = -\pi/3 \end{array}$$

Therefore

$$y_0(t) = 10 e^{-2t} \cos(3t - \frac{\pi}{3})$$

2.2-6 The characteristic polynomial is  $\lambda^2(\lambda + 1)$  or  $\lambda^3 + \lambda^2$ . The characteristic equation is  $\lambda^2(\lambda + 1) = 0$ . The characteristic roots are 0, 0 and  $-1$  (0 is repeated twice). Therefore

and

$$y_0(t) = c_1 + c_2 t + c_3 e^{-t}$$

$$\dot{y}_0(t) = c_2 - c_3 e^{-t}$$

$$\ddot{y}_0(t) = c_3 e^{-t}$$

Setting  $t = 0$ , and substituting initial conditions yields

$$\left. \begin{array}{l} 4 = c_1 + c_3 \\ 3 = c_2 - c_3 \\ -1 = c_3 \end{array} \right\} \Rightarrow \begin{array}{l} c_1 = 5 \\ c_2 = 2 \\ c_3 = -1 \end{array}$$

Therefore

$$y_0(t) = 5 + 2t - e^{-t}$$

2.2-7 The characteristic polynomial is  $(\lambda + 1)(\lambda^2 + 5\lambda + 6)$ . The characteristic equation is  $(\lambda + 1)(\lambda^2 + 5\lambda + 6) = 0$  or  $(\lambda + 1)(\lambda + 2)(\lambda + 3) = 0$ . The characteristic roots are  $-1, -2$  and  $-3$ . The characteristic modes are  $e^{-t}, e^{-2t}$  and  $e^{-3t}$ . Therefore

and

$$y_0(t) = c_1 e^{-t} + c_2 e^{-2t} + c_3 e^{-3t}$$

$$\dot{y}_0(t) = -c_1 e^{-t} - 2c_2 e^{-2t} - 3c_3 e^{-3t}$$

$$\ddot{y}_0(t) = c_1 e^{-t} + 4c_2 e^{-2t} + 9c_3 e^{-3t}$$

Setting  $t = 0$ , and substituting initial conditions yields

$$\left. \begin{array}{l} 2 = c_1 + c_2 + c_3 \\ -1 = -c_1 - 2c_2 - 3c_3 \\ 5 = c_1 + 4c_2 + 9c_3 \end{array} \right\} \Rightarrow \begin{array}{l} c_1 = 6 \\ c_2 = -7 \\ c_3 = 3 \end{array}$$

Therefore

$$y_0(t) = 6e^{-t} - 7e^{-2t} + 3e^{-3t}$$

2.3-1 The characteristic equation is  $\lambda^2 + 4\lambda + 3 = (\lambda + 1)(\lambda + 3) = 0$ . The characteristic modes are  $e^{-t}$  and  $e^{-3t}$ . Therefore

$$y_n(t) = c_1 e^{-t} + c_2 e^{-3t}$$

$$\dot{y}_n(t) = -c_1 e^{-t} - 3c_2 e^{-3t}$$

Setting  $t = 0$ , and substituting  $y(0) = 0, \dot{y}(0) = 1$ , we obtain

$$\left. \begin{array}{l} 0 = c_1 + c_2 \\ 1 = -c_1 - 3c_2 \end{array} \right\} \Rightarrow \begin{array}{l} c_1 = \frac{1}{2} \\ c_2 = -\frac{1}{2} \end{array}$$

Therefore

$$y_n(t) = \frac{1}{2}(e^{-t} - e^{-3t})$$

$$h(t) = [P(D)y_n(t)]u(t) = [(D+5)y_n(t)]u(t) = [\dot{y}_n(t) + 5y_n(t)]u(t) = (2e^{-t} - e^{-3t})u(t)$$

**2.3-2** The characteristic equation is  $\lambda^2 + 5\lambda + 6 = (\lambda + 2)(\lambda + 3) = 0$ . and

$$\begin{aligned} y_n(t) &= c_1 e^{-2t} + c_2 e^{-3t} \\ \dot{y}_n(t) &= -2c_1 e^{-2t} - 3c_2 e^{-3t} \end{aligned}$$

Setting  $t = 0$ , and substituting  $y(0) = 0$ ,  $\dot{y}(0) = 1$ , we obtain

$$\left. \begin{aligned} 0 &= c_1 + c_2 \\ 1 &= -2c_1 - 3c_2 \end{aligned} \right\} \implies \begin{aligned} c_1 &= 1 \\ c_2 &= -1 \end{aligned}$$

Therefore

$$y_n(t) = e^{-2t} - e^{-3t}$$

and

$$[P(D)y_n(t)]u(t) = [\ddot{y}_n(t) + 7\dot{y}_n(t) + 11y_n(t)]u(t) = (e^{-2t} + e^{-3t})u(t)$$

Hence

$$h(t) = b_n \delta(t) + [P(D)y_n(t)]u(t) = \delta(t) + (e^{-2t} + e^{-3t})u(t)$$

**2.3-3** The characteristic equation is  $\lambda + 1 = 0$  and

$$y_n(t) = ce^{-t}$$

In this case the initial condition is  $y_n^{n-1}(0) = y_n(0) = 1$ . Setting  $t = 0$ , and using  $y_n(0) = 1$ , we obtain  $c = 1$ , and

$$\begin{aligned} y_n(t) &= e^{-t} \\ P(D)y_n(t) &= [-\dot{y}_n(t) + y_n(t)]u(t) = 2e^{-t}u(t) \end{aligned}$$

Hence

$$h(t) = b_n \delta(t) + [P(D)y_n(t)]u(t) = -\delta(t) + 2e^{-t}u(t)$$

**2.3-4** The characteristic equation is  $\lambda^2 + 6\lambda + 9 = (\lambda + 3)^2 = 0$ . Therefore

$$\begin{aligned} y_n(t) &= (c_1 + c_2 t)e^{-3t} \\ \dot{y}_n(t) &= [-3(c_1 + c_2 t) + c_2]e^{-3t} \end{aligned}$$

Setting  $t = 0$ , and substituting  $y_n(0) = 1$ ,  $\dot{y}_n(0) = 1$ , we obtain

$$\left. \begin{aligned} 0 &= c_1 \\ 1 &= -3c_1 + c_2 \end{aligned} \right\} \implies \begin{aligned} c_1 &= 0 \\ c_2 &= 1 \end{aligned}$$

and

$$y_n(t) = te^{-3t}$$

Hence

$$h(t) = [P(D)y_n(t)]u(t) = [2\dot{y}_n(t) + 9y_n(t)]u(t) = (2 + 3t)e^{-3t}u(t)$$

**2.4-1**

$$\begin{aligned} A_c &= \int_{-\infty}^{\infty} c(t) dt \\ &= \int_{-\infty}^{\infty} \left[ \int_{-\infty}^{\infty} f(\tau)g(t-\tau) d\tau \right] dt \\ &= \int_{-\infty}^{\infty} \left[ \int_{-\infty}^{\infty} f(\tau) d\tau \right] g(t-\tau) dt \\ &= A_f \int_{-\infty}^{\infty} g(t-\tau) dt \\ &= A_f A_g \end{aligned}$$

This property can be readily verified from Examples 2.7 and 2.8. For Example 2.6, we note that

$$\int_{-\infty}^{\infty} e^{-at} dt = \frac{1}{a}$$

Use of this result yields  $A_f = 1$ ,  $A_h = 0.5$ , and  $A_y = 1 - 0.5 = 0.5 = A_f A_h$ . For example 2.8,  $A_f = 2$ ,  $A_g = 1.5$ , and

$$\begin{aligned} A_c &= \int_{-1}^1 -\frac{1}{6}(t+1)^2 dt + \int_1^2 \frac{2}{3}t dt + \int_2^4 -\frac{1}{6}(t^2 - 2t - 8) dt \\ &= \frac{4}{9} + 1 + \frac{14}{9} = 3 = A_f A_g \end{aligned}$$

2.4-2

$$\begin{aligned} f(at) * g(at) &= \int_{-\infty}^{\infty} f(a\tau)g[a(t-\tau)] d\tau \\ &= \frac{1}{a} \int_{-\infty}^{\infty} f(x)g(at-x) dx \\ &= \frac{1}{a} c(at) \quad a \geq 0 \end{aligned}$$

When  $a < 0$ , the limits of integration become from  $\infty$  to  $-\infty$ , which is equivalent to the limits from  $-\infty$  to  $\infty$  with a negative sign. Hence,  $f(at) * g(at) = |\frac{1}{a}|c(at)$ .

2.4-3 Let  $f(t) * g(t) = c(t)$ . Using the time scaling property in Prob. 2.4-2 with  $a = -1$ , we have  $f(-t) * g(-t) = c(-t)$ . Now, if  $f(t)$  and  $g(t)$  are both even functions of  $t$ , then  $f(t) = f(-t)$  and  $g(t) = g(-t)$ . Clearly  $c(t) = c(-t)$ . Using a parallel argument, we can show that if both functions are odd,  $c(t) = c(-t)$ , indicating that  $c(t)$  is even. But if one is odd and the other is even,  $c(t) = -c(-t)$ , indicating that  $c(t)$  is odd.

2.4-4

$$\begin{aligned} e^{-at}u(t) * e^{-bt}u(t) &= \int_0^t e^{-a\tau}e^{-b(t-\tau)} d\tau = e^{-bt} \int_0^t e^{(b-a)\tau} d\tau \\ &= \frac{e^{-bt}}{b-a} e^{(b-a)\tau} \Big|_0^t = \frac{e^{-bt}}{b-a} [e^{(b-a)t} - 1] = \frac{e^{-at} - e^{-bt}}{a-b} \end{aligned}$$

Because both functions are causal, their convolution is zero for  $t < 0$ . Therefore

$$e^{-at}u(t) * e^{-bt}u(t) = \left( \frac{e^{-at} - e^{-bt}}{a-b} \right) u(t)$$

2.4-5 (i)

$$\begin{aligned} u(t) * u(t) &= \int_0^t u(\tau)u(t-\tau) d\tau = \int_0^t d\tau = \tau \Big|_0^t = t \quad \text{for } t \geq 0 \\ &= 0 \quad \text{for } t < 0 \end{aligned}$$

Therefore

$$u(t) * u(t) = tu(t)$$

(ii) Because both functions are causal

$$\begin{aligned} e^{-at}u(t) * e^{-at}u(t) &= \int_0^t e^{-a\tau}e^{-a(t-\tau)} d\tau = e^{-at} \int_0^t d\tau \\ &= te^{-at} \quad t \geq 0 \end{aligned}$$

and

$$e^{-at}u(t) * e^{-at}u(t) = te^{-at}u(t)$$

(iii) Because both functions are causal

$$tu(t) * u(t) = \int_0^t \tau u(\tau) u(\tau - t) d\tau$$

The range of integration is  $0 \leq \tau \leq t$ . Therefore  $\tau > 0$  and  $\tau - t > 0$  so that  $u(\tau) = u(\tau - t) = 1$  and

$$tu(t) * u(t) = \int_0^t \tau d\tau = \frac{t^2}{2} \quad t \geq 0$$

and

$$tu(t) * u(t) = \frac{1}{2}t^2 u(t)$$

2.4-6 (i)

$$\sin t u(t) * u(t) = \left( \int_0^t \sin \tau u(\tau) u(t - \tau) d\tau \right) u(t)$$

Because  $\tau$  and  $t - \tau$  are both nonnegative (when  $0 \leq \tau \leq t$ ),  $u(\tau) = u(t - \tau) = 1$ , and

$$\sin t u(t) * u(t) = \left( \int_0^t \sin \tau d\tau \right) u(t) = (1 - \cos t)u(t)$$

(ii) Similarly

$$\cos t u(t) * u(t) = \left( \int_0^t \cos \tau d\tau \right) u(t) = \sin t u(t)$$

2.4-7 In this problem, we use Table 2.1 to find the desired convolution.

$$(a) \quad y(t) = h(t) * f(t) = e^{-t}u(t) * u(t) = (1 - e^{-t})u(t)$$

$$(b) \quad y(t) = h(t) * f(t) = e^{-t}u(t) * e^{-t}u(t) = te^{-t}u(t)$$

$$(c) \quad y(t) = e^{-t}u(t) * e^{-2t}u(t) = (e^{-t} - e^{-2t})u(t)$$

$$(d) \quad y(t) = \sin 3tu(t) * e^{-t}u(t)$$

Here we use pair 12 (Table 2.1) with  $\alpha = 0$ ,  $\beta = 3$ ,  $\theta = -90^\circ$  and  $\lambda = -1$ . This yields

$$\phi = \tan^{-1} \left[ \frac{-3}{-1} \right] = -108.4^\circ$$

and

$$\begin{aligned} \sin 3t u(t) * e^{-t} u(t) &= \frac{(\cos 18.4^\circ)e^{-t} - \cos(3t + 18.4^\circ)}{\sqrt{10}} u(t) \\ &= \frac{0.9486e^{-t} - \cos(3t + 18.4^\circ)}{\sqrt{10}} u(t) \end{aligned}$$

2.4-8 (a)

$$\begin{aligned} y(t) &= (2e^{-3t} - e^{-2t})u(t) * u(t) = 2e^{-3t}u(t) * u(t) - e^{-2t}u(t) * u(t) \\ &= \left[ \frac{2(1 - e^{-3t})}{3} - \frac{1 - e^{-2t}}{2} \right] u(t) \\ &= \left( \frac{1}{6} - \frac{2}{3}e^{-3t} + \frac{1}{2}e^{-2t} \right) u(t) \end{aligned}$$

(b)

$$\begin{aligned} (2e^{-3t} - e^{-2t})u(t) * e^{-t}u(t) &= 2e^{-3t}u(t) * e^{-t}u(t) - e^{-2t}u(t) * e^{-t}u(t) \\ &= \left[ \frac{2(e^{-t} - e^{-3t})}{2} - \frac{e^{-t} - e^{-2t}}{1} \right] u(t) \\ &= (e^{-2t} - e^{-3t})u(t) \end{aligned}$$

(c)

$$\begin{aligned} y(t) &= (2e^{-3t} - e^{-2t})u(t) * e^{-2t}u(t) = 2e^{-3t}u(t) * e^{-2t}u(t) - e^{-2t}u(t) * e^{-2t}u(t) \\ &= \left[ \frac{2(e^{-2t} - e^{-3t})}{1} - te^{-2t} \right] u(t) \\ &= [(2 - t)e^{-2t} - 2e^{-3t}]u(t) \end{aligned}$$

2.4-9

$$\begin{aligned} y(t) &= (1 - 2t)e^{-2t}u(t) * u(t) = e^{-2t}u(t) * u(t) - 2te^{-2t}u(t) * u(t) \\ &= \left[ \left( \frac{1 - e^{-2t}}{2} \right) - \left( \frac{1}{2} - \frac{1}{2}e^{-2t} - te^{-2t} \right) \right] u(t) \\ &= te^{-2t}u(t) \end{aligned}$$

2.4-10 (a) For  $y(t) = 4e^{-2t} \cos 3t u(t) * u(t)$ , We use pair 12 with  $\alpha = 2$ ,  $\beta = 3$ ,  $\theta = 0$ ,  $\lambda = 0$ . Therefore

$$\phi = \tan^{-1} \left[ \frac{-3}{2} \right] = -56.31^\circ$$

and

$$\begin{aligned} y(t) &= 4 \left[ \frac{\cos(56.31^\circ) - e^{-2t} \cos(3t + 56.31^\circ)}{\sqrt{4+9}} \right] u(t) \\ &= \frac{4}{\sqrt{13}} [0.555 - e^{-2t} \cos(3t + 56.31^\circ)] u(t) \end{aligned}$$

(b) For  $y(t) = 4e^{-2t} \cos 3tu(t) * e^{-t}u(t)$ , we use pair 12 with  $\alpha = 2$ ,  $\beta = 3$ ,  $\theta = 0$ , and  $\lambda = -1$ . Therefore

$$\phi = \tan^{-1} \left[ \frac{-3}{1} \right] = -71.56^\circ$$

and

$$\begin{aligned} y(t) &= 4 \left[ \frac{\cos(71.56^\circ)e^{-t} - e^{-2t} \cos(3t + 71.56^\circ)}{\sqrt{10}} \right] u(t) \\ &= \frac{4}{\sqrt{10}} [0.316e^{-t} - e^{-2t} \cos(3t + 71.56^\circ)] u(t) \\ &= 4 \left[ e^{-t} - \frac{1}{\sqrt{10}} e^{-2t} \cos(3t + 71.56^\circ) \right] u(t) \end{aligned}$$

2.4-11 (a)  $y(t) = e^{-t}u(t) * e^{-2t}u(t) = (e^{-t} - e^{-2t})u(t)$

(b)  $e^{-2(t-3)}u(t) = e^6 e^{-2t}u(t)$ , and  $y(t) = e^6 [e^{-t}u(t) * e^{-2t}u(t)] = e^6(e^{-t} - e^{-2t})u(t)$

(c)  $e^{-2t}u(t-3) = e^{-6}e^{-2(t-3)}u(t-3)$ . Now from the result in part (a) and the shift property of the convolution [Eq. (2.34)]:

$$y(t) = e^{-6} [e^{-(t-3)}u(t) - e^{-2(t-3)}] u(t-3)$$

(d)  $f(t) = u(t) - u(t-1)$ . Now  $y_1(t)$ , the system response to  $u(t)$  is given by

$$y_1(t) = e^{-t}u(t) * u(t) = (1 - e^{-t})u(t)$$

The system response to  $u(t-1)$  is  $y_1(t-1)$  because of time-invariance property. Therefore the response  $y(t)$  to  $f(t) = u(t) - u(t-1)$  is given by

$$y(t) = y_1(t) - y_1(t-1) = (1 - e^{-t})u(t) - [1 - e^{-(t-1)}]u(t-1)$$

The response is shown in Fig. S2.4-11.

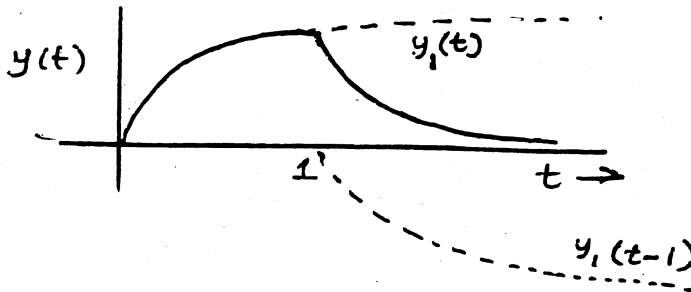

Fig. S2.4-11



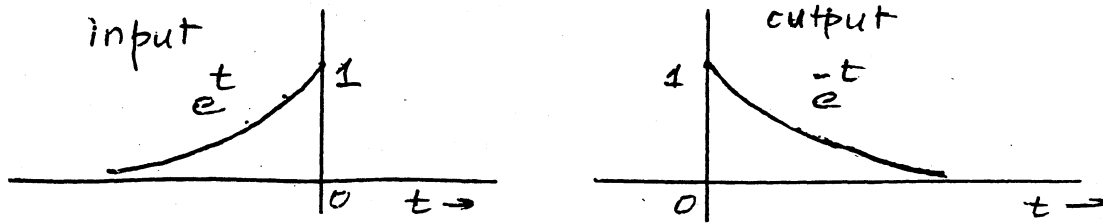

Fig. S2.4-12

2.4-12

$$\begin{aligned}
 y(t) &= [-\delta(t) + 2e^{-t}u(t)] * e^t u(-t) \\
 &= -\delta(t) * e^t u(-t) + 2e^{-t}u(t) * e^t u(-t) \\
 &= -e^t u(-t) + [e^{-t}u(t) + e^t u(-t)] \\
 &= e^{-t}u(t)
 \end{aligned}$$

2.4-13

$$\frac{1}{t^2+1} * u(t) = \int_{-\infty}^{\infty} \frac{1}{\tau^2+1} u(t-\tau) d\tau$$

Because  $u(t-\tau) = 1$  for  $\tau < t$  and is 0 for  $\tau > t$ , we need integrate only up to  $\tau = t$ .

$$\frac{1}{t^2+1} * u(t) = \int_{-\infty}^t \frac{1}{\tau^2+1} d\tau = \tan^{-1} \tau \Big|_{-\infty}^t = \tan^{-1} t + \frac{\pi}{2}$$

Figure S2.4-13 shows  $\frac{1}{t^2+1}$  and  $c(t)$  (the result of the convolution)

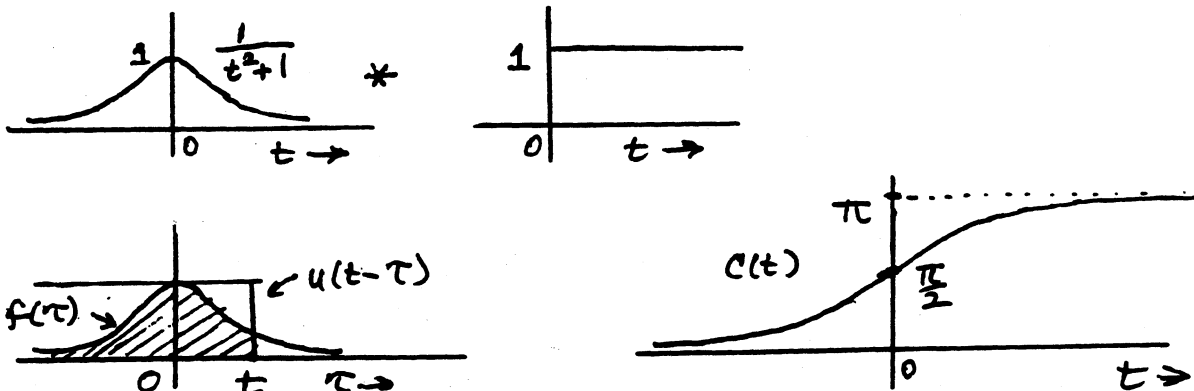

Fig. S2.4-13

2.4-14 For  $t < 2\pi$  (see Fig. S2.4-14)

$$c(t) = f(t) * g(t) = \int_0^t \sin \tau d\tau = 1 - \cos t \quad 0 \leq t \leq 2\pi$$

For  $t \geq 2\pi$ , the area of one cycle is zero and

$$f(t) * g(t) = 0 \quad t \geq 2\pi \text{ and } t < 0$$

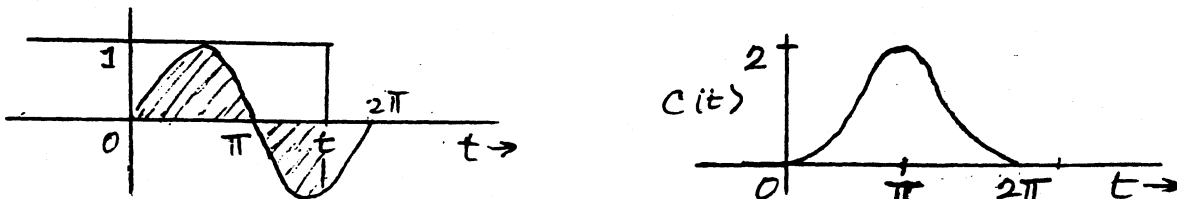

Fig. S2.4-14

2.4-15 For  $0 \leq t \leq 2\pi$  (see Fig. S2.4-15a)

$$f(t) * g(t) = \int_0^t \sin \tau d\tau = 1 - \cos t \quad 0 \leq t \leq 2\pi$$

For  $2\pi \leq t \leq 4\pi$  (Fig. S2.4-15b)

$$f(t) * g(t) = \int_{t-2\pi}^{2\pi} \sin \tau d\tau = \cos t - 1 \quad 2\pi \leq t \leq 4\pi$$

For  $t > 4\pi$  (also for  $t < 0$ ),  $f(t) * g(t) = 0$ . Figure S2.4-15c shows  $c(t)$ .

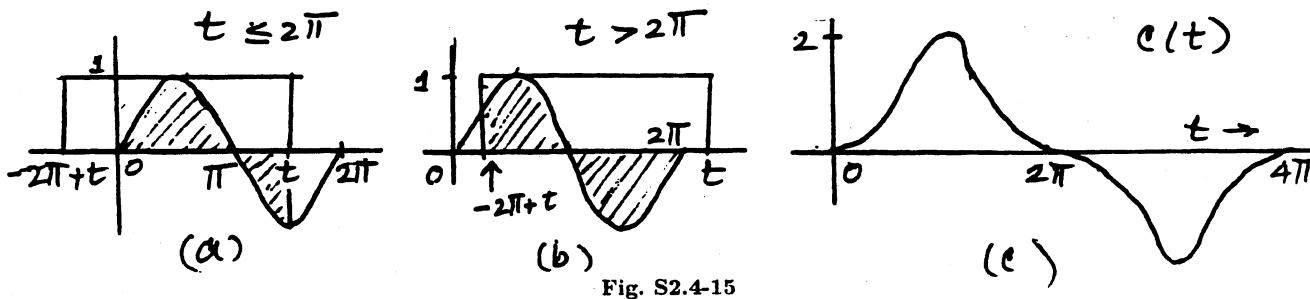

Fig. S2.4-15

2.4-16 (a)

$$c(t) = \int_{4+t}^{5+t} AB d\tau = AB \quad 0 \leq t \leq 1$$

$$c(t) = \int_{4+t}^6 AB d\tau = AB(2-t) \quad 1 \leq t \leq 2$$

$$c(t) = \int_4^{5+t} AB d\tau = AB(t+1) \quad -1 \leq t \leq 0$$

$$c(t) = 0 \quad t \geq 2 \quad \text{or} \quad t \leq -1$$

(b)

$$c(t) = \int_{3+t}^5 AB d\tau = AB(2-t) \quad 0 \leq t \leq 2$$

$$c(t) = \int_3^{5+t} AB d\tau = AB(t+2) \quad -2 \leq t \leq 0$$

$$c(t) = 0 \quad \text{for} \quad |t| \geq 2$$

(c)

$$c(t) = \int_{-1+t}^{2+t} d\tau = 3 \quad t > -1$$

$$c(t) = \int_{-2}^{2+t} d\tau = t+4 \quad -1 \geq t \geq -4$$

$$c(t) = 0 \quad t \leq -4$$

(d)

$$\begin{aligned} c(t) &= \int_t^{3+t} e^{-\tau} d\tau = e^{-t}(1 - e^{-3}) = 0.95e^{-t} \quad t \geq 0 \\ &= \int_0^{3+t} e^{-\tau} d\tau = 1 - e^{-(3+t)} = 1 - 0.0498e^{-t} \quad 0 \geq t \geq -3 \\ &= 0 \quad t \leq -3 \end{aligned}$$

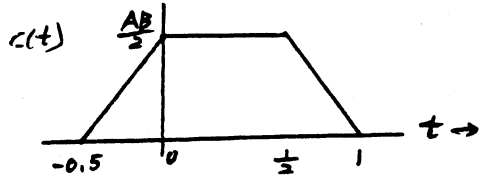
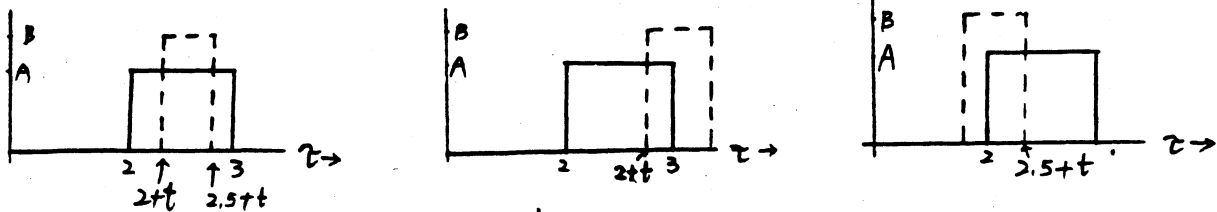

(a)

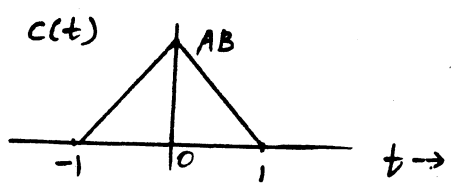
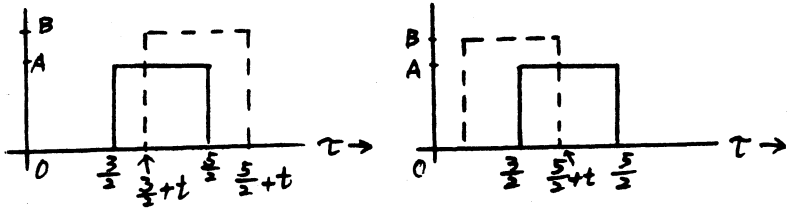

(b)

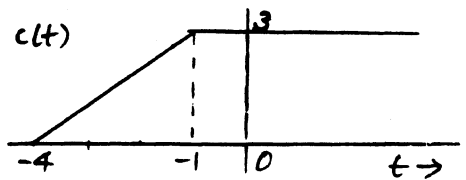
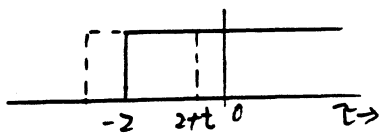

(c)

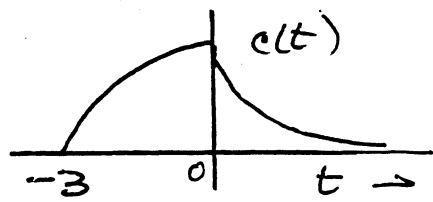
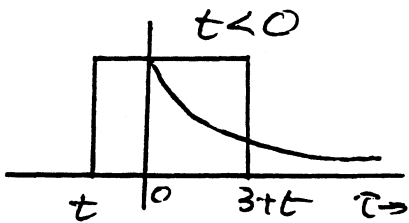
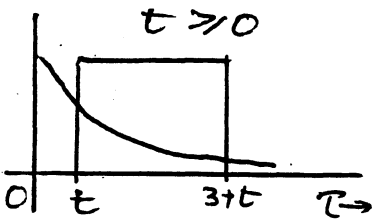

(d)

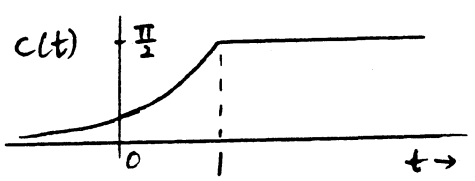
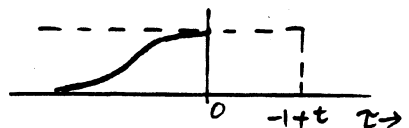
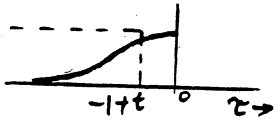

(e)

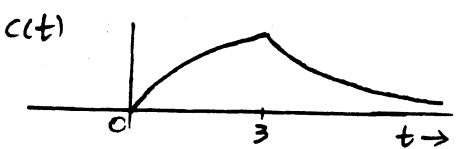
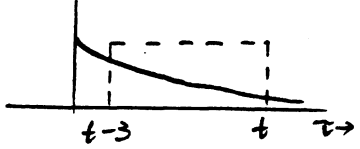
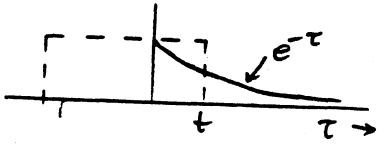

(f)

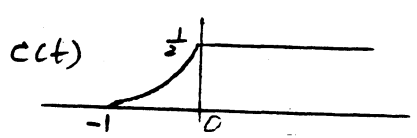
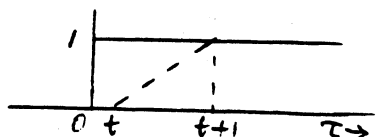
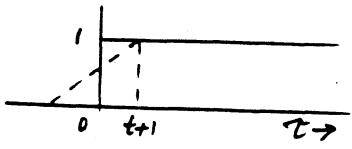

(g)

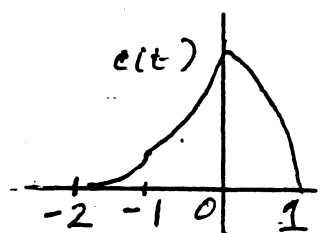
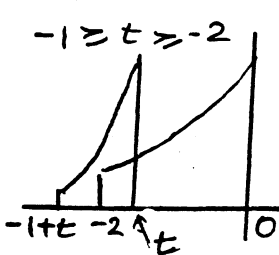
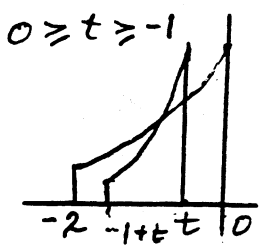
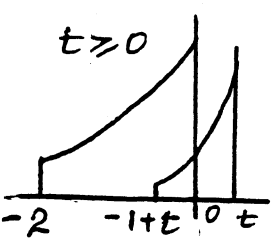

(h)

Fig. S2.4-16

(e)

$$c(t) = \int_{-\infty}^{-1+t} \frac{1}{\tau^2 + 1} d\tau = \tan^{-1}(t-1) + \frac{\pi}{2} \quad t \leq 1$$

$$c(t) = \int_{-\infty}^0 \frac{1}{\tau^2 + 1} d\tau = \tan^{-1} \tau \Big|_{-\infty}^0 = \frac{\pi}{2} \quad t \geq 1$$

(f)

$$c(t) = \int_0^t e^{-\tau} d\tau = 1 - e^{-t} \quad 0 \leq t \leq 3$$

$$c(t) = \int_{t-3}^t e^{-\tau} d\tau = e^{-(t-3)} - e^{-t} \quad t \geq 3$$

$$c(t) = 0 \quad t \leq 0$$

(g) This problem is more conveniently solved by inverting  $f_1(t)$  rather than  $f_2(t)$

$$c(t) = \int_t^{t+1} (\tau - t) d\tau = \frac{1}{2} \quad t \geq 0$$

$$c(t) = \int_0^{t+1} (\tau - t) d\tau = \frac{1}{2}(1 - t^2) \quad 0 \geq t \geq -1$$

$$c(t) = 0 \quad \text{for } t \geq 0$$

(h)  $f_1(t) = e^t$ ,  $f_2(t) = e^{-2t}$ ,  $f_1(\tau) = e^\tau$ ,  $f_2(t - \tau) = e^{-2(t-\tau)}$ .

$$c(t) = \int_{-1+t}^0 e^\tau e^{-2(t-\tau)} d\tau = e^{-2t} \int_{-1+t}^0 e^{3\tau} d\tau = \frac{1}{3}[e^{-2t} - e^{t-3}] \quad 0 \leq t \leq 1$$

$$c(t) = \int_{-1+t}^t e^\tau e^{-2(t-\tau)} d\tau = e^{-2t} \int_{-1+t}^t e^{3\tau} d\tau = \frac{1}{3}[e^t - e^{t-3}] \quad 0 \geq t \geq -1$$

$$c(t) = \int_{-2}^t e^\tau e^{-2(t-\tau)} d\tau = e^{-2t} \int_{-2}^t e^{3\tau} d\tau = \frac{1}{3}[e^t - e^{-2(t+3)}] \quad -1 \geq t \geq -2$$

$$c(t) = 0 \quad t \leq -2$$

2.4-17 Indicating the input and corresponding response graphically by an arrow, we have

$$\begin{aligned} f(t) &\longrightarrow y(t) \\ f(t-T) &\longrightarrow y(t-T) \quad (\text{by Time-invariance}) \\ f(t) - f(t-T) &\longrightarrow y(t) - y(t-T) \quad (\text{by linearity}) \end{aligned}$$

Therefore

$$\lim_{T \rightarrow 0} \frac{1}{T} [f(t) - f(t-T)] \longrightarrow \lim_{T \rightarrow 0} \frac{1}{T} [y(t) - y(t-T)]$$

The left-hand side is  $\dot{f}(t)$  and the right-hand side is  $\dot{y}(t)$ . Therefore

$$\dot{f}(t) \longrightarrow \dot{y}(t)$$

Next we recognize that

$$f(t) * u(t) = \int_{-\infty}^t f(\tau) u(t-\tau) d\tau = \int_{-\infty}^t f(\tau) d\tau \quad (1)$$

This follows from the fact that integration is performed over the range  $-\infty < \tau \leq t$ , where  $\tau \leq t$ . Hence  $u(t-\tau) = 1$ . Now the response to  $\int_{-\infty}^t f(\tau) d\tau$  is

$$[f(t) * u(t)] * h(t) = [f(t) * h(t)] * u(t) = y(t) * u(t)$$

But as shown in Eq. (1),  $y(t) * u(t)$  is  $\int_{-\infty}^t y(\tau) d\tau$ . Therefore the response to input  $\int_{-\infty}^t f(\tau) d\tau$  is  $\int_{-\infty}^t y(\tau) d\tau$ .

2.4-18 Using the hints, we obtain

$$\dot{f}(t) * g(t) = \lim_{T \rightarrow 0} \frac{1}{T} [f(t) - f(t-T)] * g(t) = f(t) * \lim_{T \rightarrow 0} \frac{1}{T} [g(t) - g(t-T)] = \lim_{T \rightarrow 0} \frac{1}{T} [c(t) - c(t-T)] = \dot{c}(t)$$

Successive applications of the above procedure yields

$$f^{(m)}(t) * g^{(n)}(t) = c^{(m+n)}(t)$$

2.4-19 The system response to  $u(t)$  is  $g(t)$  and the response to step  $u(t - \tau)$  is  $g(t - \tau)$ . The input  $f(t)$  is made up of step components. The step component at  $\tau$  has a height  $\Delta f$  which can be expressed as

$$\Delta f = \frac{\Delta f}{\Delta \tau} \Delta \tau = \dot{f}(\tau) \Delta \tau$$

The step component at  $n\Delta\tau$  has a height  $\dot{f}(n\Delta\tau)\Delta\tau$  and it can be expressed as  $[\dot{f}(n\Delta\tau)\Delta\tau]u(t - n\Delta\tau)$ . Its response  $\Delta y(t)$  is

$$\Delta y(t) = [\dot{f}(n\Delta\tau)\Delta\tau]g(t - n\Delta\tau)$$

The total response due to all components is

$$\begin{aligned} y(t) &= \lim_{\Delta\tau \rightarrow 0} \sum_{n=-\infty}^{\infty} \dot{f}(n\Delta\tau)g(t - n\Delta\tau)\Delta\tau \\ &= \int_{-\infty}^{\infty} \dot{f}(\tau)g(t - \tau) d\tau = \dot{f}(t) * g(t) \end{aligned}$$

2.4-20 An element of length  $\Delta\tau$  at point  $n\Delta\tau$  has a charge  $f(n\Delta\tau)\Delta\tau$  (Fig. S2.4-20). The electric field due to this charge at point  $x$  is

$$\Delta E = \frac{f(n\Delta\tau)\Delta\tau}{4\pi\epsilon(x - n\Delta\tau)^2}$$

The total field due to the charge along the entire length is

$$\begin{aligned} E(x) &= \lim_{\Delta\tau \rightarrow 0} \sum_{n=-\infty}^{\infty} \frac{f(n\Delta\tau)\Delta\tau}{4\pi\epsilon(x - n\Delta\tau)^2} \\ &= \int_{-\infty}^{\infty} \frac{f(\tau)}{4\pi\epsilon(x - \tau)^2} d\tau = f(x) * \frac{1}{4\pi\epsilon x} \end{aligned}$$

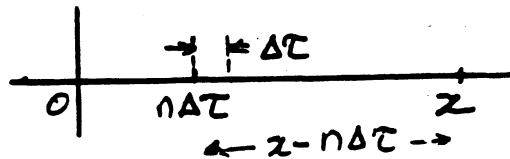

Fig. S2.4-20

2.4-21 For an ideal delay of  $T$  secs., the impulse response is  $h(t) = \delta(t - T)$ . Hence, from Eq. (2.48) (using the sampling property [Eq. (1.24b)])

$$H(s) = \int_{-\infty}^{\infty} \delta(\tau - T)e^{-s\tau} d\tau = e^{-sT}$$

We can also obtain the same result using Eq. (2.49). Let the input to an ideal delay of  $T$  seconds be an everlasting exponential  $e^{st}$ . The output is  $e^{s(t-T)}$ . Hence, according to Eq. (2.49),  $H(s) = e^{s(t-T)}/e^{st} = e^{-sT}$ .

2.5-1

$$\lambda^2 + 7\lambda + 12 = (\lambda + 3)(\lambda + 4)$$

The natural response is

$$y_n(t) = K_1 e^{-3t} + K_2 e^{-4t}$$

(a) For  $f(t) = u(t) = e^{0t}u(t)$ ,  $y_\phi(t) = H(0) = \frac{P(0)}{Q(0)} = \frac{1}{6}$

$$\begin{aligned} y(t) &= K_1 e^{-3t} + K_2 e^{-4t} + \frac{1}{6} \\ \dot{y}(t) &= -3K_1 e^{-3t} - 4K_2 e^{-4t} \end{aligned}$$

Setting  $t = 0$  and substituting initial conditions, we obtain

$$\left. \begin{aligned} 0 &= K_1 + K_2 + \frac{1}{6} \\ 1 &= -3K_1 - 4K_2 \end{aligned} \right\} \implies \begin{aligned} K_1 &= \frac{1}{3} \\ K_2 &= -\frac{1}{2} \end{aligned}$$

and

$$y(t) = \frac{1}{3}e^{-3t} - \frac{1}{2}e^{-4t} + \frac{1}{6} \quad t \geq 0$$

(b)  $f(t) = e^{-t}u(t)$ ,  $y_\phi(t) = H(-1) = \frac{P(-1)}{Q(-1)} = \frac{1}{6}$

$$\begin{aligned} y(t) &= K_1 e^{-3t} + K_2 e^{-4t} + \frac{1}{6} e^{-t} \\ \dot{y}(t) &= -3K_1 e^{-3t} - 4K_2 e^{-4t} - \frac{1}{6} e^{-t} \end{aligned}$$

Setting  $t = 0$ , and substituting initial conditions yields

$$\left. \begin{aligned} 0 &= K_1 + K_2 + \frac{1}{6} \\ 1 &= -3K_1 - 4K_2 - \frac{1}{6} \end{aligned} \right\} \implies \begin{aligned} K_1 &= -\frac{1}{2} \\ K_2 &= -\frac{2}{3} \end{aligned}$$

and

$$y(t) = \frac{1}{2}e^{-3t} - \frac{2}{3}e^{-4t} + \frac{1}{6}e^{-t} \quad t \geq 0$$

(c)  $f(t) = e^{-2t}u(t)$ ,  $y_\phi(t) = H(-2) = 0$

$$\begin{aligned} y(t) &= K_1 e^{-3t} + K_2 e^{-4t} \\ \dot{y}(t) &= -3K_1 e^{-3t} - 4K_2 e^{-4t} \end{aligned}$$

Setting  $t = 0$ , and substituting initial conditions yields

$$\left. \begin{aligned} 0 &= K_1 + K_2 \\ 1 &= -3K_1 - 4K_2 \end{aligned} \right\} \implies \begin{aligned} K_1 &= 1 \\ K_2 &= -1 \end{aligned}$$

and

$$y(t) = e^{-3t} - e^{-4t} \quad t \geq 0$$

**2.5-2**  $\lambda^2 + 6\lambda + 25 = (\lambda + 3 - j4)(\lambda + 3 + j4)$  characteristic roots are  $-3 \pm j4$

$$y_n(t) = K e^{-3t} \cos(4t + \theta)$$

For  $f(t) = u(t)$ ,  $y_\phi(t) = H(0) = \frac{3}{25}$  so that

$$\begin{aligned} y(t) &= K e^{-3t} \cos(4t + \theta) + \frac{3}{25} \\ \dot{y}(t) &= -3K e^{-3t} \cos(4t + \theta) - 4K e^{-3t} \sin(4t + \theta) \end{aligned}$$

Setting  $t = 0$ , and substituting initial conditions yields

$$\left. \begin{aligned} 0 &= K \cos \theta + \frac{3}{25} \\ 2 &= -3K \cos \theta - 4K \sin \theta \end{aligned} \right\} \implies \left. \begin{aligned} K \cos \theta &= \frac{-3}{25} \\ K \sin \theta &= \frac{-41}{100} \end{aligned} \right\} \implies \begin{aligned} K &= 0.427 \\ \theta &= -106.3 \end{aligned}$$

and

$$y(t) = 0.427e^{-3t} \cos(4t - 106.3^\circ) + \frac{3}{25} \quad t \geq 0$$

**2.5-3** Characteristic polynomial is  $\lambda^2 + 4\lambda + 4 = (\lambda + 2)^2$ . The roots are  $-2$  repeated twice.

$$y_n(t) = (K_1 + K_2 t)e^{-2t}$$

(a) For  $f(t) = e^{-3t}u(t)$ ,  $y_\phi(t) = H(-3) = -2e^{-3t}$

$$\begin{aligned}y(t) &= (K_1 + K_2t)e^{-2t} - 2e^{-3t} \\ \dot{y}(t) &= -2(K_1 + K_2t)e^{-2t} + K_2e^{-2t} + 6e^{-3t}\end{aligned}$$

Setting  $t = 0$ , and substituting initial conditions yields

$$\left. \begin{aligned}\frac{9}{4} &= K_1 - 2 \\ 5 &= -2K_1 + K_2 + 6\end{aligned} \right\} \Rightarrow \begin{aligned}K_1 &= \frac{17}{4} \\ K_2 &= \frac{15}{2}\end{aligned}$$

and

$$y(t) = \left(\frac{17}{4} + \frac{15}{2}t\right)e^{-2t} - 2e^{-3t} \quad t \geq 0$$

(b)  $f(t) = e^{-t}u(t)$ ,  $y_\phi(t) = H(-1)e^{-t} = 0$

$$\begin{aligned}y(t) &= (K_1 + K_2t)e^{-2t} \\ \dot{y}(t) &= -2(K_1 + K_2t)e^{-2t} + K_2e^{-2t}\end{aligned}$$

Setting  $t = 0$ , and substituting initial conditions yields

$$\left. \begin{aligned}\frac{9}{4} &= K_1 \\ 5 &= -2K_1 + K_2\end{aligned} \right\} \Rightarrow \begin{aligned}K_1 &= \frac{9}{4} \\ K_2 &= \frac{19}{2}\end{aligned}$$

and

$$y(t) = \left(\frac{9}{4} + \frac{19}{2}t\right)e^{-2t} \quad t \geq 0$$

**2.5-4** Because  $(\lambda^2 + 2\lambda) = \lambda(\lambda + 2)$ , the characteristic roots are 0 and  $-2$ .

$$y_n(t) = K_1 + K_2e^{-2t}$$

In this case  $f(t) = u(t)$ . The input itself is a characteristic mode. Therefore

$$y_\phi(t) = \beta t$$

But  $y_\phi(t)$  satisfied the system equation

$$(D^2 + 2D)y_\phi(t) = (D + 1)y(t) = \ddot{y}_\phi(t) + 2\dot{y}_\phi(t) = f(t) + f(t)$$

Substituting  $f(t) = u(t)$  and  $y_\phi(t) = \beta t$ , we obtain

$$0 + 2\beta = 0 + 1 \quad \Rightarrow \quad \beta = \frac{1}{2}$$

Therefore  $y_\phi(t) = \frac{1}{2}t$ .

$$\begin{aligned}y(t) &= K_1 + K_2e^{-2t} + \frac{1}{2}t \\ \dot{y}(t) &= -2K_2e^{-2t} + \frac{1}{2}\end{aligned}$$

Setting  $t = 0$ , and substituting initial conditions yields

$$\left. \begin{aligned}2 &= K_1 + K_2 \\ 1 &= -2K_2 + \frac{1}{2}\end{aligned} \right\} \Rightarrow \begin{aligned}K_1 &= \frac{9}{4} \\ K_2 &= -\frac{1}{4}\end{aligned}$$

and

$$y(t) = \frac{9}{4} - \frac{1}{4}e^{-2t} + \frac{1}{2}t \quad t \geq 0$$

**2.5-5** the natural response  $y_n(t)$  is found in Prob. 2.5-1:

$$y_n(t) = K_1e^{-3t} + K_2e^{-4t}$$

The input  $f(t) = e^{-3t}$  is a characteristic mode. Therefore

$$y_\phi(t) = \beta te^{-3t}$$

Also  $y_\phi(t)$  satisfies the system equation:

$$(D^2 + 7D + 12)y_\phi(t) = (D + 2)f(t)$$

or

$$\ddot{y}_\phi(t) + 7\dot{y}_\phi(t) + 12y_\phi(t) = \dot{f}(t) + 2f(t)$$

Substituting  $f(t) = e^{-3t}$  and  $y_\phi(t) = \beta te^{-3t}$  in this equation yields

$$(9\beta t - 6\beta)e^{-3t} + 7(-3\beta t + \beta)e^{-3t} + 12\beta te^{-3t} = -3e^{-3t} + 2e^{-3t}$$

or

$$\beta e^{-3t} = -e^{-3t} \implies \beta = -1$$

Therefore

$$\begin{aligned} y(t) &= K_1 e^{-3t} + K_2 e^{-4t} - t e^{-3t} \\ \dot{y}(t) &= -3K_1 e^{-3t} - 4K_2 e^{-4t} + 3t e^{-3t} - e^{-3t} \end{aligned}$$

Setting  $t = 0$ , and substituting initial conditions yields

$$\left. \begin{aligned} 0 &= K_1 + K_2 \\ 1 &= -3K_1 - 4K_2 - 1 \end{aligned} \right\} \implies \begin{aligned} K_1 &= 2 \\ K_2 &= -2 \end{aligned}$$

and

$$\begin{aligned} y(t) &= 2e^{-3t} - 2e^{-4t} - t e^{-3t} & t \geq 0 \\ &= (2-t)e^{-3t} - 2e^{-4t} & t \geq 0 \end{aligned}$$

### 2.6-1

(a)  $\lambda^2 + 8\lambda + 12 = (\lambda + 2)(\lambda + 6)$

Both roots are in LHP. The system is asymptotically stable.

(b)  $\lambda(\lambda^2 + 3\lambda + 2) = \lambda(\lambda + 1)(\lambda + 2)$

Roots are 0, -1, -2. One root on imaginary axis and none in RHP. The system is marginally stable.

(c)  $\lambda^2(\lambda^2 + 2) = \lambda^2(\lambda + j\sqrt{2})(\lambda - j\sqrt{2})$

Roots are 0 (repeated twice) and  $\pm j\sqrt{2}$ . Multiple roots on imaginary axis. The system is unstable.

(d)  $(\lambda + 1)(\lambda^2 - 6\lambda + 5) = (\lambda + 1)(\lambda - 1)(\lambda - 5)$

Roots are -1, 1 and 5. Two roots in RHP. The system is unstable.

### 2.6-2

(a)  $(\lambda + 1)(\lambda^2 + 2\lambda + 5)^2 = (\lambda + 1)(\lambda + 1 - j2)^2(\lambda + 1 + j2)^2$

Roots -1,  $-1 \pm j2$  (repeated twice) are all in LHP. The system is asymptotically stable.

(b)  $(\lambda + 1)(\lambda^2 + 9) = (\lambda + 1)(\lambda + j3)(\lambda - j3)$

Roots are -1,  $\pm j3$ . Two (simple) roots on imaginary axis, none in RHP. The system is marginally stable.

(c)  $(\lambda + 1)(\lambda^2 + 9)^2 = (\lambda + 1)(\lambda + j3)^2(\lambda - j3)^2$

Roots are -1 and  $\pm j3$  repeated twice. Multiple roots on imaginary axis. The system is unstable.

(d)  $(\lambda^2 + 1)(\lambda^2 + 4)(\lambda^2 + 9) = (\lambda + j1)(\lambda - j1)(\lambda + j2)(\lambda - j2)(\lambda + j3)(\lambda - j3)$

The roots are  $\pm j1$ ,  $\pm j2$  and  $\pm j3$ . All roots are simple and on imaginary axis. None in RHP. The system is marginally stable.

### 2.6-3

(a) Because  $u(t) = e^{0t}u(t)$ , the characteristic root is 0.

(b) The root lies on the imaginary axis, and the system is marginally stable.

(c)  $\int_0^\infty h(t) dt = \infty$

The system is BIBO unstable.

(d) The integral of  $\delta(t)$  is  $u(t)$ . The system response to  $\delta(t)$  is  $u(t)$ . Clearly, the system is an ideal integrator.

2.6-4 Assume that a system exists that violates Eq. (2.57) and yet produces a bounded output for every bounded input. The response at  $t = t_1$  is

$$y(t_1) = \int_0^\infty h(\tau)f(t_1 - \tau) d\tau$$

Consider a bounded input  $f(t)$  such that at some instant  $t_1$

$$f(t_1 - \tau) = \begin{cases} 1 & \text{if } h(\tau) > 0 \\ -1 & \text{if } h(\tau) < 0 \end{cases}$$

In this case



$$h(\tau)f(t_1 - \tau) = |h(\tau)|$$

and

$$y(t_1) = \int_0^{\infty} |h(\tau)| d\tau = \infty$$

This violates the assumption.

- 2.7-1** (a) The time-constant (rise-time) of the system is  $T_h = 10^{-5}$ .  
 The rate of pulse communication  $< \frac{1}{T_h} = 10^5$  pulses/sec. The channel cannot transmit million pulses/second.  
 (b) The bandwidth of the channel is

$$B = \frac{1}{T_h} = 10^5 \text{ Hz}$$

The channel can transmit audio signal of bandwidth 15 kHz readily.

**2.7-2**

$$T_h = \frac{1}{B} = \frac{1}{10^4} = 10^{-4} = 0.1 \text{ ms}$$

The received pulse width =  $(0.5 + 0.1) = 0.6$  ms. Each pulse takes up 0.6 ms interval. The maximum pulse rate (to avoid interference between successive pulses) is

$$\frac{1}{0.6 \times 10^{-3}} \simeq 1667 \text{ pulses/sec}$$

**2.7-3** Using Eqs. (2.60) and (2.61) (a)

$$T_r = T_h = -\frac{1}{\lambda} = 10^{-4}$$

- (b) The bandwidth  $\mathcal{F}_c = 1/T_h = 1/T_r = 10^4$ .  
 (c) The pulse transmission rate is  $\mathcal{F}_c = 10^4$  pulses/sec.

# Chapter 3

---

**3.1-1** Trivial.

**3.1-2 (a)** In this case  $E_x = \int_0^1 dt = 1$ , and

$$c = \frac{1}{E_x} \int_0^1 f(t)x(t) dt = \frac{1}{1} \int_0^1 t dt = 0.5$$

**(b)** Thus,  $f(t) \approx 0.5x(t)$ , and the error  $e(t) = t - 0.5$  over  $(0 \leq t \leq 1)$ , and zero outside this interval. Also  $E_f$  and  $E_e$  (the energy of the error) are

$$E_f = \int_0^1 f^2(t) dt = \int_0^1 t^2 dt = 1/3 \quad \text{and} \quad E_e = \int_0^1 (t - 0.5)^2 dt = 1/12$$

The error  $(t - 0.5)$  is orthogonal to  $x(t)$  because

$$\int_0^1 (t - 0.5)(1) dt = 0$$

Note that  $E_f = c^2 E_x + E_e$ . To explain these results in terms of vector concepts we observe from Fig. 3.1 that the error vector  $\mathbf{e}$  is orthogonal to the component  $c\mathbf{x}$ . Because of this orthogonality, the length-square of  $\mathbf{f}$  [energy of  $f(t)$ ] is equal to the sum of the square of the lengths of  $c\mathbf{x}$  and  $\mathbf{e}$  [sum of the energies of  $cx(t)$  and  $e(t)$ ].

**3.1-3** In this case  $E_f = \int_0^1 f^2(t) dt = \int_0^1 t^2 dt = 1/3$ , and

$$c = \frac{1}{E_f} \int_0^1 x(t)f(t) dt = 3 \int_0^1 t dt = 1.5$$

Thus,  $x(t) \approx 1.5f(t)$ , and the error  $e(t) = x(t) - 1.5f(t) = 1 - 1.5t$  over  $(0 \leq t \leq 1)$ , and zero outside this interval. Also  $E_e$  (the energy of the error) is  $E_e = \int_0^1 (1 - 1.5t)^2 dt = 1/4$ .

**3.1-4 (a)** In this case  $E_x = \int_0^1 \sin^2 2\pi t dt = 0.5$ , and

$$c = \frac{1}{E_x} \int_0^1 f(t)x(t) dt = \frac{1}{0.5} \int_0^1 t \sin 2\pi t dt = -1/\pi$$

**(b)** Thus,  $f(t) \approx -(1/\pi)x(t)$ , and the error  $e(t) = t + (1/\pi)\sin 2\pi t$  over  $(0 \leq t \leq 1)$ , and zero outside this interval. Also  $E_f$  and  $E_e$  (the energy of the error) are

$$E_f = \int_0^1 f^2(t) dt = \int_0^1 t^2 dt = 1/3 \quad \text{and} \quad E_e = \int_0^1 [t - (1/\pi)\sin 2\pi t]^2 dt = \frac{1}{3} - \frac{1}{2\pi^2}$$

The error  $[t + (1/\pi)\sin 2\pi t]$  is orthogonal to  $x(t)$  because

$$\int_0^1 \sin 2\pi t [t + (1/\pi)\sin 2\pi t] dt = 0$$

Note that  $E_f = c^2 E_x + E_e$ . To explain these results in terms of vector concepts we observe from Fig. 3.1 that the error vector  $\mathbf{e}$  is orthogonal to the component  $c\mathbf{x}$ . Because of this orthogonality, the length of  $\mathbf{f}$  [energy of  $f(t)$ ] is equal to the sum of the square of the lengths of  $c\mathbf{x}$  and  $\mathbf{e}$  [sum of the energies of  $cx(t)$  and  $e(t)$ ].

**3.1-5 (a)** If  $x(t)$  and  $y(t)$  are orthogonal, then we

showed [see Eq. (3.22)] the energy of  $x(t) + y(t)$  is  $E_x + E_y$ . We now find the energy of  $x(t) - y(t)$ :

$$\begin{aligned} \int_{-\infty}^{\infty} |x(t) - y(t)|^2 dt &= \int_{-\infty}^{\infty} |x(t)|^2 dt + \int_{-\infty}^{\infty} |y(t)|^2 dt - \int_{-\infty}^{\infty} x(t)y^*(t) dt - \int_{-\infty}^{\infty} x^*(t)y(t) dt \\ &= \int_{-\infty}^{\infty} |x(t)|^2 dt + \int_{-\infty}^{\infty} |y(t)|^2 dt \end{aligned} \quad (3.22)$$

The last result follows from the fact that because of orthogonality, the two integrals of the cross products  $x(t)y^*(t)$  and  $x^*(t)y(t)$  are zero [see Eq. (3.20)]. Thus the energy of  $x(t) + y(t)$  is equal to that of  $x(t) - y(t)$  if  $x(t)$  and  $y(t)$  are orthogonal.

(b) Using similar argument, we can show that the energy of  $c_1x(t) + c_2y(t)$  is equal to that of  $c_1x(t) - c_2y(t)$  if  $x(t)$  and  $y(t)$

are orthogonal. This energy is given by  $|c_1|^2 E_x + |c_2|^2 E_y$ .

(c) If  $z(t) = x(t) \pm y(t)$ , then

$$\begin{aligned} \int_{-\infty}^{\infty} |x(t) \pm y(t)|^2 dt &= \int_{-\infty}^{\infty} |x(t)|^2 dt + \int_{-\infty}^{\infty} |y(t)|^2 dt \pm \int_{-\infty}^{\infty} x(t)y^*(t) dt \pm \int_{-\infty}^{\infty} x^*(t)y(t) dt \\ &= E_x + E_y \pm (E_{xy} + E_{yx}) \end{aligned}$$

### 3.2-1

We shall compute  $c_n$  using Eq. (3.25) for each of the 4 cases. Let us first compute the energies of all the signals.

$$E_x = \int_0^1 \sin^2 2\pi t dt = 0.5$$

In the same way we find  $E_{f_1} = E_{f_2} = E_{f_3} = E_{f_4} = 0.5$ .

Using Eq. (3.25), the correlation coefficients for four cases are found as

$$\begin{aligned} (1) \quad \frac{1}{\sqrt{(0.5)(0.5)}} \int_0^1 \sin 2\pi t \sin 4\pi t dt &= 0 & (2) \quad \frac{1}{\sqrt{(0.5)(0.5)}} \int_0^1 (\sin 2\pi t)(-\sin 2\pi t) dt &= -1 \\ (3) \quad \frac{1}{\sqrt{(0.5)(0.5)}} \int_0^1 0.707 \sin 2\pi t dt &= 0 & (4) \quad \frac{1}{\sqrt{(0.5)(0.5)}} \left[ \int_0^{0.5} 0.707 \sin 2\pi t dt - \int_{0.5}^1 0.707 \sin 2\pi t dt \right] &= 1.414/\pi \end{aligned}$$

Signals  $x(t)$  and  $f_2(t)$  provide the maximum protection against noise.

**3.3-1**  $f_1(2, -1)$ ,  $f_2(-1, 2)$ ,  $f_3(0, -2)$ ,  $f_4(1, 2)$ ,  $f_5(2, 1)$ , and  $f_6(3, 0)$ . From the figure, we see that pairs  $(f_3, f_6)$ ,  $(f_1, f_4)$  and  $(f_2, f_5)$  are orthogonal. We can verify this also analytically.

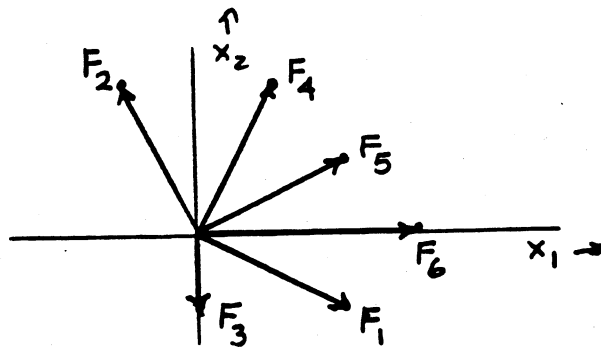

Fig. S3.3-1

$$f_3 \cdot f_6 = (0 \times 3) + (-2 \times 0) = 0$$

$$f_1 \cdot f_4 = (2 \times 1) + (-1 \times 2) = 0$$

$$f_2 \cdot f_5 = (-1 \times 2) + (2 \times 1) = 0$$

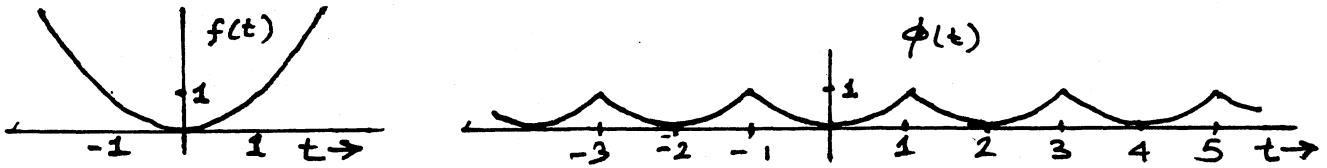

Fig. S3.4-1

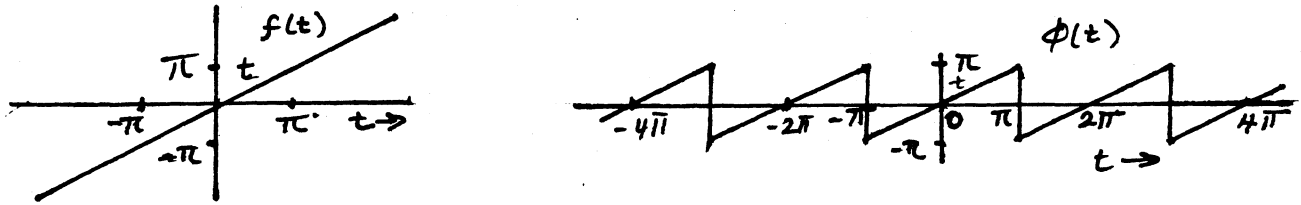

Fig. S3.4-2

We can show that the corresponding signal pairs are also orthogonal.

$$\begin{aligned} \int_{-\infty}^{\infty} f_3(t)f_6(t) dt &= \int_{-\infty}^{\infty} [-x_2(t)][3x_1(t)] dt = 0 \\ \int_{-\infty}^{\infty} f_1(t)f_4(t) dt &= \int_{-\infty}^{\infty} [2x_1(t) - x_2(t)][x_1(t) + 2x_2(t)] dt = 0 \\ \int_{-\infty}^{\infty} f_2(t)f_5(t) dt &= \int_{-\infty}^{\infty} [-x_1(t) + 2x_2(t)][2x_1(t) + x_2(t)] dt = 0 \end{aligned}$$

In deriving these results, we used the fact that  $\int_{-\infty}^{\infty} x_1^2 dt = \int_{-\infty}^{\infty} x_2^2 dt = 1$  and  $\int_{-\infty}^{\infty} x_1(t)x_2(t) dt = 0$

3.4-1 Here  $T_0 = 2$ , so that  $\omega_0 = 2\pi/2 = \pi$ , and

$$f(t) = a_0 + \sum_{n=1}^{\infty} a_n \cos n\pi t + b_n \sin n\pi t \quad -1 \leq t \leq 1$$

where

$$a_0 = \frac{1}{2} \int_{-1}^1 t^2 dt = \frac{1}{3}, \quad a_n = \frac{2}{2} \int_{-1}^1 t^2 \cos n\pi t dt = \frac{4(-1)^n}{\pi^2 n^2}, \quad b_n = \frac{2}{2} \int_{-1}^1 t^2 \sin n\pi t dt = 0$$

Therefore

$$f(t) = \frac{1}{3} + \frac{4}{\pi^2} \sum_{n=1}^{\infty} \frac{(-1)^n}{n^2} \cos n\pi t \quad -1 \leq t \leq 1$$

Figure S3.4-1 shows  $f(t) = t^2$  for all  $t$  and the corresponding Fourier series representing  $f(t)$  over  $(-1, 1)$ .

3.4-2 Here  $T_0 = 2\pi$ , so that  $\omega_0 = 2\pi/2\pi = 1$ , and

$$f(t) = a_0 + \sum_{n=1}^{\infty} a_n \cos nt + b_n \sin nt \quad -\pi \leq t \leq \pi$$

where

$$a_0 = \frac{1}{2\pi} \int_{-\pi}^{\pi} t dt = 0, \quad a_n = \frac{2}{2\pi} \int_{-\pi}^{\pi} t \cos nt dt = 0, \quad b_n = \frac{2}{2\pi} \int_{-\pi}^{\pi} t \sin nt dt = \frac{2(-1)^{n+1}}{n}$$

Therefore

$$f(t) = 2(-1)^{n+1} \sum_{n=1}^{\infty} \frac{1}{n} \sin nt \quad -\pi \leq t \leq \pi$$

Figure S3.4-2 shows  $f(t) = t$  for all  $t$  and the corresponding Fourier series to represent  $f(t)$  over  $(-\pi, \pi)$ .

3.4-3 (a)  $T_0 = 4$ ,  $\omega_0 = \frac{2\pi}{T_0} = \frac{\pi}{2}$ . Because of even symmetry, all sine terms are zero.

$$f(t) = a_0 + \sum_{n=1}^{\infty} a_n \cos\left(\frac{n\pi}{2}t\right)$$

$$a_0 = 0 \text{ (by inspection)}$$

$$a_n = \frac{4}{4} \left[ \int_0^1 \cos\left(\frac{n\pi}{2}t\right) dt - \int_1^2 \cos\left(\frac{n\pi}{2}t\right) dt \right] = \frac{4}{n\pi} \sin \frac{n\pi}{2}$$

Therefore, the Fourier series for  $f(t)$  is

$$f(t) = \frac{4}{\pi} \left( \cos \frac{\pi t}{2} - \frac{1}{3} \cos \frac{3\pi t}{2} + \frac{1}{5} \cos \frac{5\pi t}{2} - \frac{1}{7} \cos \frac{7\pi t}{2} + \dots \right)$$

Here  $b_n = 0$ , and we allow  $C_n$  to take negative values. Figure S3.4-3a shows the plot of  $C_n$ .  
**(b)**  $T_0 = 10\pi$ ,  $\omega_0 = \frac{2\pi}{T_0} = \frac{1}{5}$ . Because of even symmetry, all the sine terms are zero.

$$f(t) = a_0 + \sum_{n=1}^{\infty} a_n \cos\left(\frac{n}{5}t\right) + b_n \sin\left(\frac{n}{5}t\right)$$

$$a_0 = \frac{1}{5} \quad \text{(by inspection)}$$

$$a_n = \frac{2}{10\pi} \int_{-\pi}^{\pi} \cos\left(\frac{n}{5}t\right) dt = \frac{1}{5\pi} \left(\frac{5}{n}\right) \sin\left(\frac{n}{5}t\right) \Big|_{-\pi}^{\pi} = \frac{2}{\pi n} \sin\left(\frac{n\pi}{5}\right)$$

$$b_n = \frac{2}{10\pi} \int_{-\pi}^{\pi} \sin\left(\frac{n}{5}t\right) dt = 0 \quad \text{(integrand is an odd function of } t \text{)}$$

Here  $b_n = 0$ , and we allow  $C_n$  to take negative values. Note that  $C_n = a_n$  for  $n = 0, 1, 2, 3, \dots$ . Figure S3.4-3b shows the plot of  $C_n$ .

**(c)**  $T_0 = 2\pi$ ,  $\omega_0 = 1$ .

$$f(t) = a_0 + \sum_{n=1}^{\infty} a_n \cos nt + b_n \sin nt \quad \text{with } a_0 = 0.5 \text{ (by inspection)}$$

$$a_n = \frac{1}{\pi} \int_0^{2\pi} \frac{t}{2\pi} \cos nt dt = 0, \quad b_n = \frac{1}{\pi} \int_0^{2\pi} \frac{t}{2\pi} \sin nt dt = -\frac{1}{\pi n}$$

and

$$f(t) = 0.5 - \frac{1}{\pi} \left( \sin t + \frac{1}{2} \sin 2t + \frac{1}{3} \sin 3t + \frac{1}{4} \sin 4t + \dots \right)$$

$$= 0.5 + \frac{1}{\pi} \left[ \cos\left(t + \frac{\pi}{2}\right) + \frac{1}{2} \cos\left(2t + \frac{\pi}{2}\right) + \frac{1}{3} \cos\left(3t + \frac{\pi}{2}\right) + \dots \right]$$

The reason for vanishing of the cosines terms is that when 0.5 (the dc component) is subtracted from  $f(t)$ , the remaining function has odd symmetry. Hence, the Fourier series would contain dc and sine terms only. Figure S3.4-3c shows the plot of  $C_n$  and  $\theta_n$ .

**(d)**  $T_0 = \pi$ ,  $\omega_0 = 2$  and  $f(t) = \frac{4}{\pi}t$ .

$a_0 = 0$  (by inspection).

$a_n = 0$  ( $n > 0$ ) because of odd symmetry.

$$b_n = \frac{4}{\pi} \int_0^{\pi/4} \frac{4}{\pi} t \sin 2nt dt = \frac{2}{\pi n} \left( \frac{2}{\pi n} \sin \frac{\pi n}{2} - \cos \frac{\pi n}{2} \right)$$

$$f(t) = \frac{4}{\pi^2} \sin 2t + \frac{1}{\pi} \sin 4t - \frac{4}{9\pi^2} \sin 6t - \frac{1}{2\pi} \sin 8t + \dots$$

$$= \frac{4}{\pi^2} \cos\left(2t - \frac{\pi}{2}\right) + \frac{1}{\pi} \cos\left(4t - \frac{\pi}{2}\right) + \frac{4}{9\pi^2} \cos\left(6t + \frac{\pi}{2}\right) + \frac{1}{\pi} \cos\left(8t + \frac{\pi}{2}\right) + \dots$$

Figure S3.4-3d shows the plot of  $C_n$  and  $\theta_n$ .

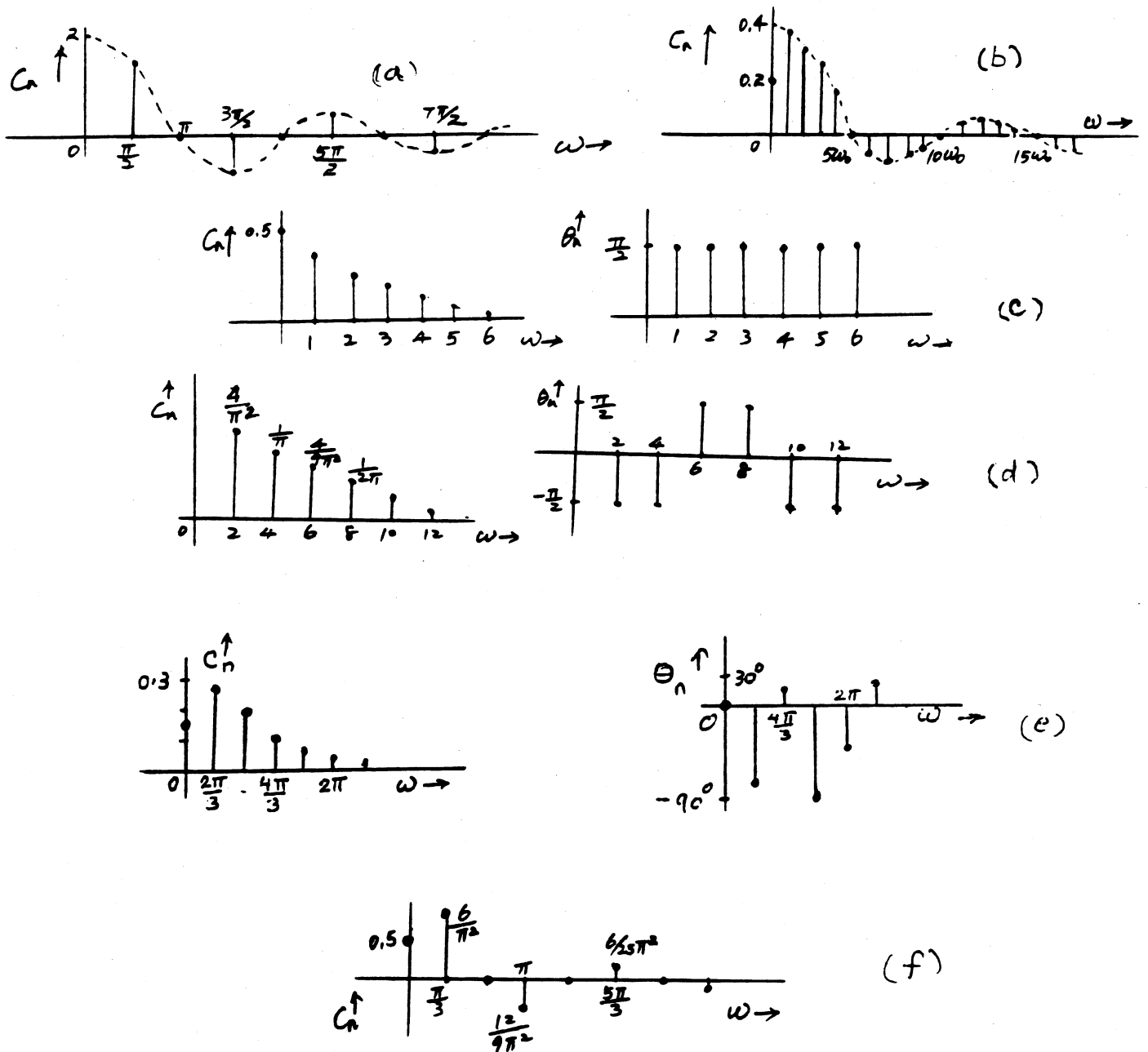

Fig. S3.4-3

(e)  $T_0 = 3, \omega_0 = 2\pi/3$ .

$$a_0 = \frac{1}{3} \int_0^1 t dt = \frac{1}{6}$$

$$a_n = \frac{2}{3} \int_0^1 t \cos \frac{2n\pi}{3} t dt = \frac{3}{2\pi^2 n^2} \left[ \cos \frac{2\pi n}{3} + \frac{2\pi n}{3} \sin \frac{2\pi n}{3} - 1 \right]$$

$$b_n = \frac{2}{3} \int_0^1 t \sin \frac{2n\pi}{3} t dt = \frac{3}{2\pi^2 n^2} \left[ \sin \frac{2\pi n}{3} - \frac{2\pi n}{3} \cos \frac{2\pi n}{3} \right]$$

Therefore  $C_0 = \frac{1}{6}$  and

$$C_n = \frac{3}{2\pi^2 n^2} \left[ \sqrt{2 + \frac{4\pi^2 n^2}{9} - 2 \cos \frac{2\pi n}{3} - \frac{4\pi n}{3} \sin \frac{2\pi n}{3}} \right] \quad \text{and} \quad \theta_n = \tan^{-1} \left( \frac{\frac{2\pi n}{3} \cos \frac{2\pi n}{3} - \sin \frac{2\pi n}{3}}{\cos \frac{2\pi n}{3} + \frac{2\pi n}{3} \sin \frac{2\pi n}{3} - 1} \right)$$

(f)  $T_0 = 6$ ,  $\omega_0 = \pi/3$ ,  $a_0 = 0.5$  (by inspection). Even symmetry;  $b_n = 0$ .

$$\begin{aligned} a_n &= \frac{4}{6} \int_0^3 f(t) \cos \frac{n\pi}{3} t dt \\ &= \frac{2}{3} \left[ \int_0^1 \cos \frac{n\pi}{3} t dt + \int_1^2 (2-t) \cos \frac{n\pi}{3} t dt \right] \\ &= \frac{6}{\pi^2 n^2} \left[ \cos \frac{n\pi}{3} - \cos \frac{2n\pi}{3} \right] \end{aligned}$$

$$f(t) = 0.5 + \frac{6}{\pi^2} \left( \cos \frac{\pi}{3} t - \frac{2}{9} \cos \pi t + \frac{1}{25} \cos \frac{5\pi}{3} t + \frac{1}{49} \cos \frac{7\pi}{3} t + \dots \right)$$

Observe that even harmonics vanish. The reason is that if the dc (0.5) is subtracted from  $f(t)$ , the resulting function has half-wave symmetry. (See Prob. 3.4-7). Figure S3.4-3f shows the plot of  $C_n$ .

3.4-4 (a)

Here  $T_0 = \pi$ , and  $\omega_0 = \frac{2\pi}{T_0} = 2$ . Therefore

$$f(t) = a_0 + \sum_{n=1}^{\infty} a_n \cos 2nt + b_n \sin 2nt$$

To compute the coefficients, we shall use the interval  $-\pi$  to 0 for integration. Thus

$$a_0 = \frac{1}{\pi} \int_{-\pi}^0 e^{t/2} dt = 0.504$$

$$a_n = \frac{2}{\pi} \int_{-\pi}^0 e^{t/2} \cos 2nt dt = 0.504 \left( \frac{2}{1+16n^2} \right)$$

$$b_n = \frac{2}{\pi} \int_{-\pi}^0 e^{t/2} \sin 2nt dt = -0.504 \left( \frac{8n}{1+16n^2} \right)$$

Therefore

$$C_0 = a_0 = 0.504, \quad C_n = \sqrt{a_n^2 + b_n^2} = 0.504 \left( \frac{2}{\sqrt{1+16n^2}} \right), \quad \theta_n = \tan^{-1} \left( \frac{-b_n}{a_n} \right) = \tan^{-1} 4n$$

$$f(t) = 0.504 + 0.504 \sum_{n=1}^{\infty} \frac{2}{\sqrt{1+16n^2}} \cos(2nt + \tan^{-1} 4n)$$

(b) This Fourier series is identical to that in Eq. (3.56a) with  $t$  replaced by  $-t$ .

(c) If  $f(t) = C_0 + \sum C_n \cos(n\omega_0 t + \theta_n)$ , then

$$f(-t) = C_0 + \sum C_n \cos(-n\omega_0 t + \theta_n) = C_0 + \sum C_n \cos(n\omega_0 t - \theta_n)$$

Thus, time inversion of a signal merely changes the sign of the phase  $\theta_n$ . Everything else remains unchanged. Comparison of the above results in part (a) with those in Example 3.3 confirms this conclusion.

3.4-5 (a) Here  $T_0 = \pi/2$ , and  $\omega_0 = \frac{2\pi}{T_0} = 4$ . Therefore

$$f(t) = a_0 + \sum_{n=1}^{\infty} a_n \cos 4nt + b_n \sin 4nt$$

where

$$a_0 = \frac{2}{\pi} \int_0^{\pi/2} e^{-t} dt = 0.504$$

$$a_n = \frac{4}{\pi} \int_0^{\pi/2} e^{-t} \cos 4nt dt = 0.504 \left( \frac{2}{1+16n^2} \right)$$

and

$$b_n = \frac{4}{\pi} \int_0^{\pi/2} e^{-t} \sin 4nt dt = 0.504 \left( \frac{8n}{1+16n^2} \right)$$

Therefore

$$C_0 = a_0 = 0.504, \quad C_n = \sqrt{a_n^2 + b_n^2} = 0.504 \left( \frac{2}{\sqrt{1+16n^2}} \right), \quad \theta_n = -\tan^{-1} 4n$$

(b) This Fourier series is identical to that in Eq. (3.56a) with  $t$  replaced by  $2t$ .

(c) If  $f(t) = C_0 + \sum C_n \cos(n\omega_0 t + \theta_n)$ , then

$$f(at) = C_0 + \sum C_n \cos(n(a\omega_0)t + \theta_n)$$

Thus, time scaling by a factor  $a$  merely scales the fundamental frequency by the same factor  $a$ . Everything else remains unchanged. If we time compress (or time expand) a periodic signal by a factor  $a$ , its fundamental frequency increases by the same factor  $a$  (or decreases by the same factor  $a$ ). Comparison of the results in part (a) with those in Example 3.3 confirms this conclusion. This result applies equally well

**3.4-6 (a)** Here  $T_0 = 2$ , and  $\omega_0 = \frac{2\pi}{T_0} = \pi$ . Also  $f(t)$  is an even function of  $t$ . Therefore

$$f(t) = a_0 + \sum_{n=1}^{\infty} a_n \cos n\pi t$$

where, by inspection  $a_0 = 0$  and from Eq. (3.66b)

$$a_n = \frac{4}{2} \int_0^1 A(-2t+1) \cos n\pi t dt = -\frac{4}{\pi^2 n^2} (\cos n\pi t - 1) \Big|_0^1 = \begin{cases} 0 & n \text{ even} \\ \frac{8A}{n^2 \pi^2} & n \text{ odd} \end{cases}$$

Therefore

$$f(t) = \frac{8A}{\pi^2} \left[ \cos \pi t + \frac{1}{9} \cos 3\pi t + \frac{1}{25} \cos 5\pi t + \frac{1}{49} \cos 7\pi t + \dots \right]$$

(b) This Fourier series is identical to that in Eq. (3.63) with  $t$  replaced by  $t + 0.5$ .

(c) If  $f(t) = C_0 + \sum C_n \cos(n\omega_0 t + \theta_n)$ , then

$$f(t+T) = C_0 + \sum C_n \cos[n\omega_0(t+T) + \theta_n] = C_0 + \sum C_n \cos[n\omega_0 t + (\theta_n + n\omega_0 T)]$$

Thus, time shifting by  $T$  merely increases the phase of the  $n$ th harmonic by  $n\omega_0 T$ .

**3.4-7 (a)** For half wave symmetry

$$f(t) = -f\left(t \pm \frac{T_0}{2}\right)$$

and

$$\text{and} \quad a_n = \frac{2}{T_0} \int_0^{T_0} f(t) \cos n\omega_0 t dt = \frac{2}{T_0} \int_0^{T_0/2} f(t) \cos n\omega_0 t dt + \int_{T_0/2}^{T_0} f(t) \cos n\omega_0 t dt$$

Let  $x = t - T_0/2$  in the second integral. This gives

$$\begin{aligned} a_n &= \frac{2}{T_0} \left[ \int_0^{T_0/2} f(t) \cos n\omega_0 t dt + \int_0^{T_0/2} f\left(x + \frac{T_0}{2}\right) \cos n\omega_0 \left(x + \frac{T_0}{2}\right) dx \right] \\ &= \frac{2}{T_0} \left[ \int_0^{T_0/2} f(t) \cos n\omega_0 t dt + \int_0^{T_0/2} -f(x) [-\cos n\omega_0 x] dx \right] \\ &= \frac{4}{T_0} \left[ \int_0^{T_0/2} f(t) \cos n\omega_0 t dt \right] \end{aligned}$$

In a similar way we can show that

$$b_n = \frac{4}{T_0} \int_0^{T_0/2} f(t) \sin n\omega_0 t dt$$

(b) (i)  $T_0 = 8$ ,  $\omega_0 = \frac{\pi}{4}$ ,  $a_0 = 0$  (by inspection). Half wave symmetry. Hence

$$\begin{aligned} a_n &= \frac{4}{8} \left[ \int_0^4 f(t) \cos \frac{n\pi}{4} t dt \right] = \frac{1}{2} \left[ \int_0^2 \frac{t}{2} \cos \frac{n\pi}{4} t dt \right] \\ &= \frac{4}{n^2 \pi^2} \left( \cos \frac{n\pi}{2} + \frac{n\pi}{2} \sin \frac{n\pi}{2} - 1 \right) \quad (n \text{ odd}) \\ &= \frac{4}{n^2 \pi^2} \left( \frac{n\pi}{2} \sin \frac{n\pi}{2} - 1 \right) \quad (n \text{ odd}) \end{aligned}$$



Therefore

$$a_n = \begin{cases} \frac{4}{n^2\pi^2} \left( \frac{n\pi}{2} - 1 \right) & n = 1, 5, 9, 13, \dots \\ -\frac{4}{n^2\pi^2} \left( \frac{n\pi}{2} + 1 \right) & n = 3, 7, 11, 15, \dots \end{cases}$$

Similarly

$$b_n = \frac{1}{2} \int_0^2 \frac{t}{2} \sin \frac{n\pi}{4} t dt = \frac{4}{n^2\pi^2} \left( \sin \frac{n\pi}{2} - \frac{n\pi}{2} \cos \frac{n\pi}{2} \right) = \frac{4}{n^2\pi^2} \sin \left( \frac{n\pi}{2} \right) \quad (n \text{ odd}).$$

and

$$f(t) = \sum_{n=1,3,5,\dots}^{\infty} a_n \cos \frac{n\pi}{4} t + b_n \sin \frac{n\pi}{4} t$$

(ii)  $T_0 = 2\pi$ ,  $\omega_0 = 1$ ,  $a_0 = 0$  (by inspection). Half wave symmetry. Hence

$$f(t) = \sum_{n=1,3,5,\dots}^{\infty} a_n \cos nt + b_n \sin nt$$

$$\begin{aligned} a_n &= \frac{2}{\pi} \int_0^{\pi} e^{-t/10} \cos nt dt \\ &= \frac{2}{\pi} \left[ \frac{e^{-t/10}}{n^2 + 0.01} (-0.1 \cos nt + n \sin nt) \right]_0^{\pi} \quad (n \text{ odd}) \\ &= \frac{2}{\pi} \left[ \frac{e^{-\pi/10}}{n^2 + 0.01} (0.1) - \frac{1}{n^2 + 0.01} (-0.1) \right] \\ &= \frac{2}{10\pi(n^2 + 0.01)} (e^{-\pi/10} - 1) = \frac{0.0465}{n^2 + 0.01} \end{aligned}$$

and

$$\begin{aligned} b_n &= \frac{2}{\pi} \int_0^{\pi} e^{-t/10} \sin nt dt \\ &= \frac{2}{\pi} \left[ \frac{e^{-t/10}}{n^2 + 0.01} (-0.1 \sin nt - n \cos nt) \right]_0^{\pi} \quad (n \text{ odd}) \\ &= \frac{2n}{(n^2 + 0.01)} (e^{-\pi/10} - 1) = \frac{1.461n}{n^2 + 0.01} \end{aligned}$$

**3.4-8** (a) Here, we need only cosine terms and  $\omega_0 = \frac{\pi}{2}$ . Hence, we must construct a pulse such that it is an even function of  $t$ , has a value  $t$  over the interval  $0 \leq t \leq 1$ , and repeats every 4 seconds as shown in Fig. S3.4-8a. We selected the pulse width  $W = 2$  seconds. But it can be anywhere from 2 to 4, and still satisfy these conditions. Each value of  $W$  results in different series. Yet all of them converge to  $t$  over 0 to 1, and satisfy the other requirements. Clearly, there are infinite number of Fourier series that will satisfy the given requirements. The present choice yields

$$f(t) = a_0 + \sum_{n=1}^{\infty} a_n \cos \left( \frac{n\pi}{2} \right) t$$

By inspection, we find  $a_0 = 1/4$ . Because of symmetry  $b_n = 0$  and

$$a_n = \frac{4}{4} \int_0^1 t \cos \frac{n\pi}{2} t dt = \frac{4}{n^2\pi^2} \left[ \cos \left( \frac{n\pi}{2} \right) + \frac{n\pi}{2} \sin \left( \frac{n\pi}{2} \right) - 1 \right]$$

(b) Here, we need only sine terms and  $\omega_0 = 2$ . Hence, we must construct a pulse with odd symmetry, which has a value  $t$  over the interval  $0 \leq t \leq 1$ , and repeats every  $\pi$  seconds as shown in Fig. S3.4-8b. As in the case (a), the pulse width can be anywhere from 1 to  $\pi$ . For the present case

$$f(t) = \sum_{n=1}^{\infty} b_n \sin 2nt$$

Because of odd symmetry,  $a_n = 0$  and

$$b_n = \frac{4}{\pi} \int_0^1 t \sin 2nt \, dt = \frac{1}{\pi n^2} (\sin 2n - 2n \cos 2n)$$

(c) Here, we need both sine and cosine terms and  $\omega_0 = \frac{\pi}{2}$ . Hence, we must construct a pulse such that it has no symmetry of any kind, has a value  $t$  over the interval  $0 \leq t \leq 1$ , and repeats every 4 seconds as shown in Fig. S3.4-8c. As usual, the pulse width can be have any value in the range 1 to 4.

$$f(t) = a_0 + \sum_{n=1}^{\infty} a_n \cos\left(\frac{n\pi}{2}t\right) + b_n \sin\left(\frac{n\pi}{2}t\right)$$

By inspection,  $a_0 = 1/8$  and

$$a_n = \frac{2}{4} \int_0^1 t \cos \frac{n\pi}{2} t \, dt = \frac{2}{n^2 \pi^2} \left[ \cos\left(\frac{n\pi}{2}\right) + \frac{n\pi}{2} \sin\left(\frac{n\pi}{2}\right) - 1 \right]$$

$$b_n = \frac{2}{4} \int_0^1 t \sin \frac{n\pi}{2} t \, dt = \frac{2}{n^2 \pi^2} \left[ \sin\left(\frac{n\pi}{2}\right) - \frac{n\pi}{2} \cos\left(\frac{n\pi}{2}\right) \right]$$

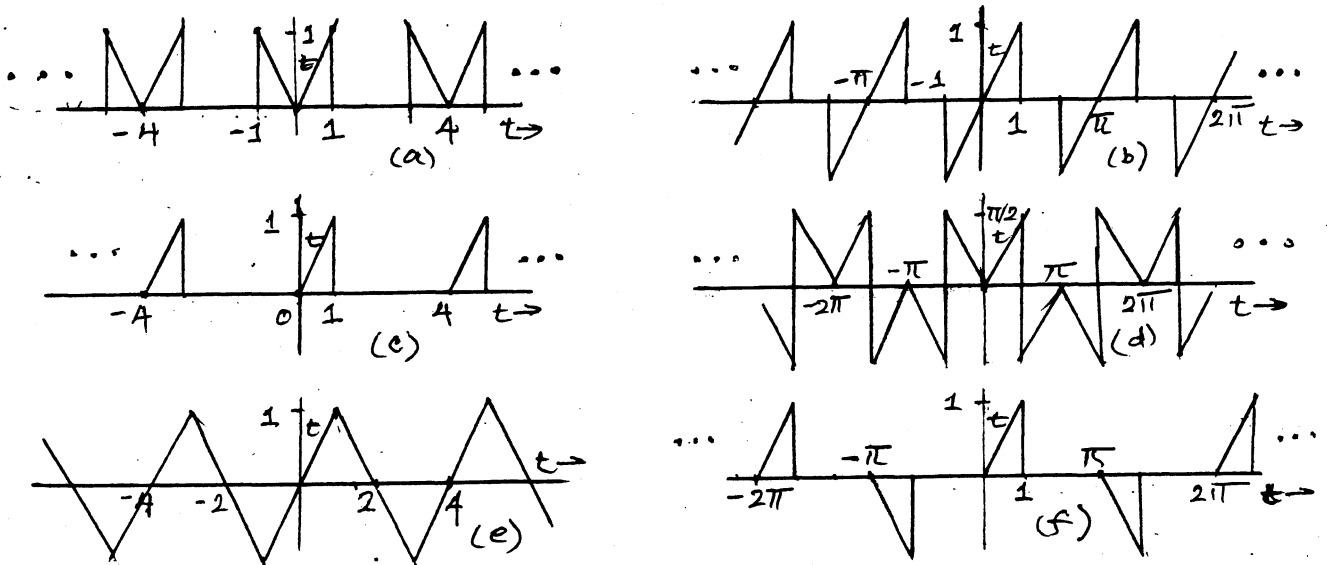

Fig. S3.4-8

(d) Here, we need only cosine terms with  $\omega_0 = 1$  and odd harmonics only. Hence, we must construct a pulse such that it is an even function of  $t$ , has a value  $t$  over the interval  $0 \leq t \leq 1$ , repeats every  $2\pi$  seconds and has half-wave symmetry as shown in Fig. S3.4-8d. Observe that the first half cycle (from 0 to  $\pi$ ) and the second half cycle (from  $\pi$  to  $2\pi$ ) are negatives of each other as required in half-wave symmetry. This will cause even harmonics to vanish. The pulse has an even and half-wave symmetry. This yields

$$f(t) = a_0 + \sum_{\substack{n=1 \\ n \text{ odd}}}^{\infty} a_n \cos nt$$

By inspection,  $a_0 = 0$ . Because of even symmetry  $b_n = 0$ . Because of half-wave symmetry (see Prob. 3.4-7),

$$a_n = \frac{4}{2\pi} \left[ \int_0^{\pi/2} t \cos nt \, dt - \int_{\pi/2}^{\pi} (t - \pi) \cos nt \, dt \right] = \frac{2}{\pi n^2} (\cos n\pi - 1) + \frac{2}{n} \sin \frac{n\pi}{2} \quad n \text{ odd}$$

(e) Here, we need only sine terms with  $\omega_0 = \pi$  and odd harmonics only. Hence, we must construct a pulse such that it is an odd function of  $t$ , has a value  $t$  over the interval  $0 \leq t \leq 1$ , repeats every 4 seconds and has half-wave symmetry as shown in Fig. S3.4-8e. Observe that the first half cycle (from 0 to 2) and the second half cycle (from 2 to 4) are negatives of each other as required in half-wave symmetry. This will cause even harmonics to vanish. The pulse has an odd and half-wave symmetry. This yields

$$f(t) = \sum_{\substack{n=1 \\ n \text{ odd}}}^{\infty} b_n \sin \frac{n\pi}{2} t$$

By inspection,  $a_0 = 0$ . Because of odd symmetry  $a_n = 0$ . Because of half-wave symmetry (see Prob. 3.4-7),

$$b_n = \frac{4}{4} \int_0^1 t \sin \frac{n\pi}{2} t dt + \int_1^2 (-t+2) \sin \frac{n\pi}{2} t dt = \frac{8}{n^2 \pi^2} \sin \frac{n\pi}{2} \quad n \text{ odd}$$

(f) Here, we need both sine and cosine terms with  $\omega_0 = 1$  and odd harmonics only. Hence, we must construct a pulse such that it has half-wave symmetry, but neither odd nor even symmetry, has a value  $t$  over the interval  $0 \leq t \leq 1$ , and repeats every  $2\pi$  seconds as shown in Fig. S3.4-8f. Observe that the first half cycle from 0 to  $\pi$  and the second half cycle (from  $\pi$  to  $2\pi$ ) are negatives of each other as required in half-wave symmetry. By inspection,  $a_0 = 0$ . This yields

$$f(t) = \sum_{\substack{n=1 \\ n \text{ odd}}}^{\infty} a_n \cos nt + b_n \sin nt$$

Because of half-wave symmetry (see Prob. 3.4-7),

$$a_n = \frac{4}{2\pi} \int_0^1 t \cos nt dt = \frac{2}{\pi n^2} (\cos n + n \sin n - 1) \quad b_n = \frac{4}{2\pi} \int_0^1 t \sin nt dt = \frac{2}{\pi n^2} (\sin n - n \cos n) \quad n \text{ odd}$$

### 3.4-9

	a	b	c	d	e	f	g	h	i
periodic?	yes	yes	no	yes	no	yes	yes	yes	yes
$\omega_0$	1	1		$\pi$		$\frac{1}{70}$	$\frac{3}{4}$	1	2
period	$2\pi$	$2\pi$		2		$140\pi$	$\frac{8\pi}{3}$	$2\pi$	$\pi$

### 3.4-10

$$f(t) = a_0 + \sum_{n=1}^{\infty} a_n \cos 2\pi nt + b_n \sin 2\pi nt \quad \left( \omega_0 = \frac{2\pi}{1} \right)$$

$$a_0 = 1 \int_0^1 f(t) dt = \int_0^1 t dt = \frac{1}{2}$$

$$a_n = 2 \int_0^1 t \cos 2\pi nt dt = 0 \quad n \geq 1 \quad (n \text{ integer})$$

$$b_n = 2 \int_0^1 t \sin 2\pi nt dt = \frac{-1}{\pi n}$$

Hence

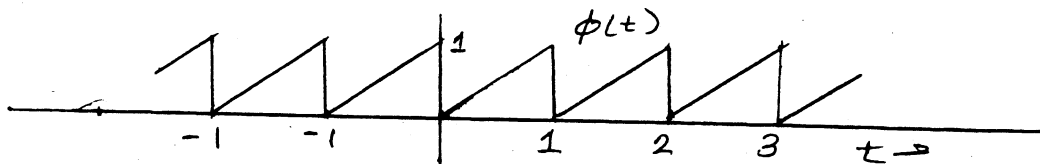

Figure S3.4-10

$$\begin{aligned}
f(t) &= \frac{1}{2} + \frac{1}{\pi} \left( \sin 2\pi t + \frac{1}{2} \sin 4\pi t + \frac{1}{3} \sin 6\pi t + \dots \right) \\
&= \frac{1}{2} + \frac{1}{\pi} \sum_{n=1}^{\infty} \frac{1}{n} \sin 2\pi n t
\end{aligned}$$

If  $E_e(N)$  is the energy of the error signal in the approximation using first  $N$  terms, then From Eq. (3.40)

$$E_e(N) = 1 \int_0^1 f^2(t) dt - \left[ \left( \frac{1}{2} \right)^2 + \frac{1}{2} \left[ \left( \frac{1}{\pi} \right)^2 + \left( \frac{1}{2\pi} \right)^2 + \dots + \left( \frac{1}{(N-1)\pi} \right)^2 \right] \right]$$

(Note that  $E_n = 1/2$  for  $n = 1, 2, \dots$  and  $E_0 = 1$ )

$$E_e(1) = \int_0^1 t^2 dt - \frac{1}{4} = \frac{1}{3} - \frac{1}{4} = \frac{1}{12}$$

$$E_e(2) = \frac{1}{3} - \frac{1}{4} - \frac{1}{2\pi^2} = 0.03267$$

$$E_e(3) = \frac{1}{3} - \frac{1}{4} - \frac{1}{2\pi^2} - \frac{1}{8\pi^2} = 0.02$$

$$E_e(4) = \frac{1}{3} - \frac{1}{4} - \frac{1}{2\pi^2} - \frac{1}{8\pi^2} - \frac{1}{18\pi^2} = 0.014378$$

### 3.4-11

$$f(t) = c_0 x_0(t) + c_1 x_1(t) + \dots + c_7 x_7(t)$$

$$\text{Since } E_n = \int_0^1 x_n(t) dt = 1$$

$$c_0 = \int_0^1 f(t) x_0(t) dt = \frac{1}{2}$$

$$c_1 = \int_0^1 f(t) x_1(t) dt = -\frac{1}{4}$$

$$c_2 = c_4 = c_5 = c_6 = 0$$

$$c_3 = \int_0^1 f(t) x_3(t) dt = -\frac{1}{8}$$

$$c_7 = \int_0^1 f(t) x_7(t) dt = -\frac{1}{16}$$

Hence

$$f(t) \simeq \frac{1}{2} x_0(t) - \frac{1}{4} x_1(t) - \frac{1}{8} x_3(t) - \frac{1}{16} x_7(t)$$

Also

$$\int_0^1 f^2(t) dt = \frac{1}{3} \quad \text{and} \quad E_n = 1$$

If  $E_e(N)$  is the energy of the error signal in the approximation using first  $N$  terms, then From Eq. (3.40)

$$E_e(1) = \frac{1}{3} - c_0^2 = \frac{1}{12} = 0.0833$$

$$E_e(2) = \frac{1}{3} - c_0^2 - c_1^2 = \frac{1}{48} = 0.0204$$

$$E_e(3) = \frac{1}{3} - c_0^2 - c_1^2 - c_3^2 = \frac{1}{192} = 0.0052$$

$$E_e(4) = \frac{1}{3} - c_0^2 - c_1^2 - c_3^2 - c_7^2 = \frac{1}{768} = 0.001302$$

The Walsh Fourier series gives small error than the trigonometric Fourier series (in prob. 3.4-10) for the same number of terms in the approximation.

**3.4-12**

$$f(t) = c_0 p_0(t) + c_1 p_1(t) + \dots + c_j p_j(t)$$

$$c_0 = \frac{1}{2} \int_{-1}^1 f(t) dt = 0 \quad \text{Also} \quad c_2 = c_4 = c_6 = \dots = 0$$

$$c_1 = \frac{3}{2} \int_{-1}^1 t f(t) dt = -\frac{3}{2} \quad c_3 = \frac{7}{2} \int_{-1}^1 t f(t) \left[ \frac{5}{2} t^3 - \frac{3}{2} t \right] dt = \frac{7}{8}$$

Hence

$$f(t) = -\frac{3}{2}t + \frac{7}{8} \left( \frac{5}{2}t^3 - \frac{3}{2}t \right) + \dots$$

$$\text{Also} \quad \int_{-1}^1 f^2(t) dt = 2 \quad \text{and using Eq. (3.40)}$$

$$E_e(1) = \int f^2(t) dt - \frac{1}{3}c_1^2 = 2 - \frac{3}{2} = 0.5$$

$$E_e(2) = \int f^2(t) dt - \frac{1}{3}c_1^2 - \frac{1}{7}c_3^2 = 0.28125$$

(b) This is a scaled version (time-expansion by factor  $2\pi$ ) of the signal  $f(t)$  in pair a.

$$f_b(t) = f\left(\frac{t}{\pi}\right) = -\frac{3}{2}\left(\frac{t}{\pi}\right) + \frac{7}{8} \left[ \frac{5}{2}\left(\frac{t}{\pi}\right)^3 - \frac{3}{2}\left(\frac{t}{\pi}\right) \right] + \dots$$

**3.5-1 (a):**  $T_0 = 4, \omega_0 = \pi/2$ . Also  $D_0 = 0$  (by inspection).

$$D_n = \frac{1}{2\pi} \int_{-1}^1 e^{-j(n\pi/2)t} dt - \int_1^3 e^{-j(n\pi/2)t} dt = \frac{2}{\pi n} \sin \frac{n\pi}{2} \quad |n| \geq 1$$

(b)  $T_0 = 10\pi, \omega_0 = 2\pi/10\pi = 1/5$

$$f(t) = \sum_{n=-\infty}^{\infty} D_n e^{j\frac{n}{5}t}, \quad \text{where} \quad D_n = \frac{1}{10\pi} \int_{\pi}^{\pi} e^{-j\frac{n}{5}t} dt = \frac{j}{2\pi n} \left( -2j \sin \frac{n\pi}{5} \right) = \frac{1}{\pi n} \sin \left( \frac{n\pi}{5} \right)$$

(c)

$$f(t) = D_0 + \sum_{n=-\infty}^{\infty} D_n e^{jnt}, \quad \text{where, by inspection} \quad D_0 = 0.5$$

$$D_n = \frac{1}{2\pi} \int_0^{2\pi} \frac{t}{2\pi} e^{-jnt} dt = \frac{j}{2\pi n}, \quad \text{so that} \quad |D_n| = \frac{1}{2\pi n}, \quad \text{and} \quad \angle D_n = \begin{cases} \frac{\pi}{2} & n > 0 \\ -\frac{\pi}{2} & n < 0 \end{cases}$$

(d)  $T_0 = \pi, \omega_0 = 2$  and  $D_n = 0$

$$f(t) = \sum_{n=-\infty}^{\infty} D_n e^{j2nt}, \quad \text{where} \quad D_n = \frac{1}{\pi} \int_{-\pi/4}^{\pi/4} \frac{4t}{\pi} e^{-j2nt} dt = \frac{-j}{\pi n} \left( \frac{2}{\pi n} \sin \frac{\pi n}{2} - \cos \frac{\pi n}{2} \right)$$

(e)  $T_0 = 3, \omega_0 = \frac{2\pi}{3}$ .

$$f(t) = \sum_{n=-\infty}^{\infty} D_n e^{j\frac{2\pi n}{3}t}, \quad \text{where} \quad D_n = \frac{1}{3} \int_0^1 t e^{-j\frac{2\pi n}{3}t} dt = \frac{3}{4\pi^2 n^2} \left[ e^{-j\frac{2\pi n}{3}} \left( \frac{j2\pi n}{3} + 1 \right) - 1 \right]$$

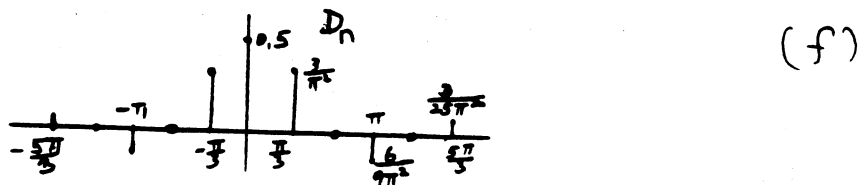
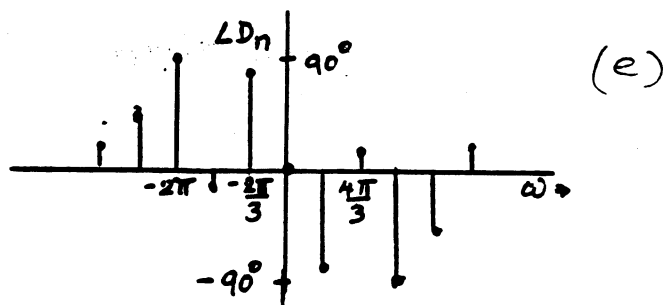
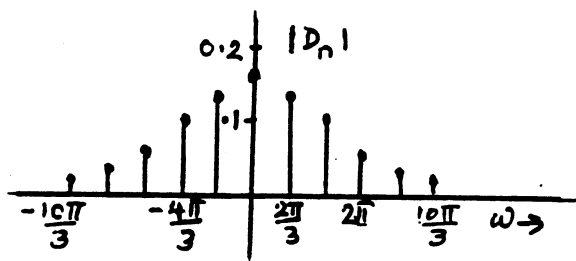
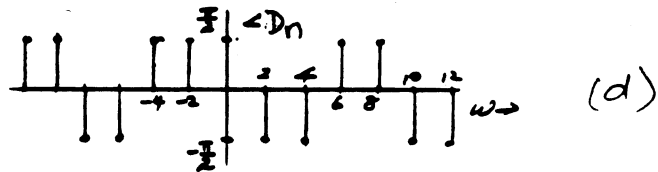
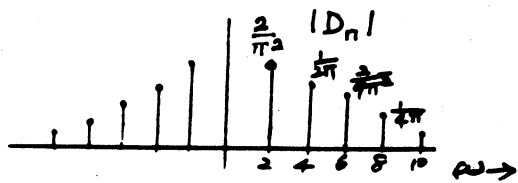
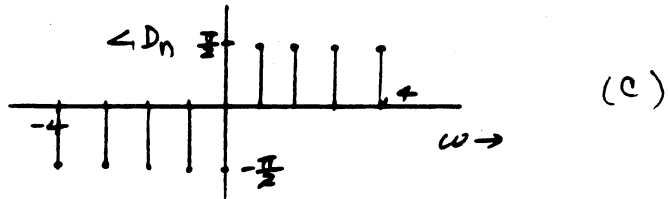
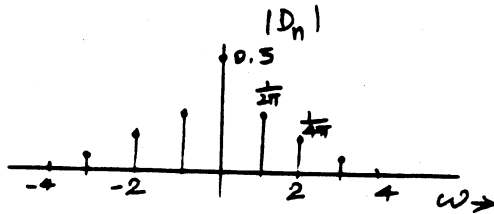
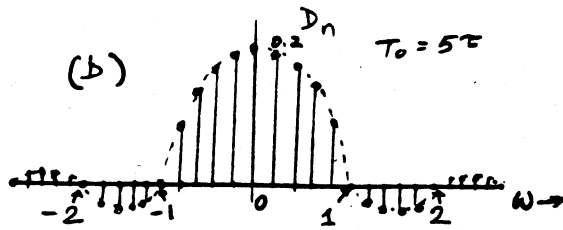
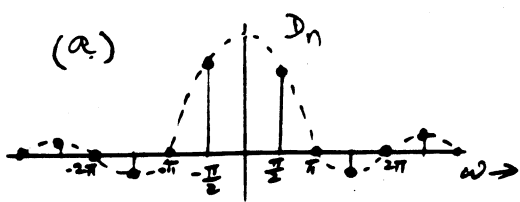

Fig. S3.5-1

Therefore

$$|D_n| = \frac{3}{4\pi^2 n^2} \left[ \sqrt{2 + \frac{4\pi^2 n^2}{9} - 2 \cos \frac{2\pi n}{3} - \frac{4\pi n}{3} \sin \frac{2\pi n}{3}} \right] \text{ and } \angle D_n = \tan^{-1} \left( \frac{\frac{2\pi n}{3} \cos \frac{2\pi n}{3} - \sin \frac{2\pi n}{3}}{\cos \frac{2\pi n}{3} + \frac{2\pi n}{3} \sin \frac{2\pi n}{3} - 1} \right)$$

(f)  $T_0 = 6, \omega_0 = \pi/3, D_0 = 0.5$

$$f(t) = 0.5 + \sum_{n=-\infty}^{\infty} D_n e^{j\frac{\pi n t}{3}}$$

$$D_n = \frac{1}{6} \left[ \int_{-2}^{-1} (t+2) e^{-j\frac{\pi n t}{3}} dt + \int_{-1}^1 e^{-j\frac{\pi n t}{3}} dt + \int_1^2 (-t+2) e^{-j\frac{\pi n t}{3}} dt \right] = \frac{3}{\pi^2 n^2} \left( \cos \frac{n\pi}{3} - \cos \frac{2\pi n}{3} \right)$$

3.5-2 In compact trigonometric form, all terms are of cosine form and amplitudes are positive. We can express  $f(t)$  as

$$\begin{aligned} f(t) &= 3 + 2 \cos\left(2t - \frac{\pi}{6}\right) + \cos\left(3t - \frac{\pi}{2}\right) + \frac{1}{2} \cos\left(5t + \frac{\pi}{3} - \pi\right) \\ &= 3 + 2 \cos\left(2t - \frac{\pi}{6}\right) + \cos\left(3t - \frac{\pi}{2}\right) + \frac{1}{2} \cos\left(5t - \frac{2\pi}{3}\right) \end{aligned}$$

From this expression we sketch the trigonometric Fourier spectra as shown in Fig. S3.5-2a. By inspection of these spectra, we sketch the exponential Fourier spectra shown in Fig. S3.5-2b. From these exponential spectra, we can now write the exponential Fourier series as

$$f(t) = 3 + e^{j(2t - \frac{\pi}{6})} + e^{-j(2t - \frac{\pi}{6})} + \frac{1}{2} e^{j(3t - \frac{\pi}{2})} + \frac{1}{2} e^{-j(3t - \frac{\pi}{2})} + \frac{1}{4} e^{j(5t - \frac{2\pi}{3})} + \frac{1}{4} e^{-j(5t - \frac{2\pi}{3})}$$

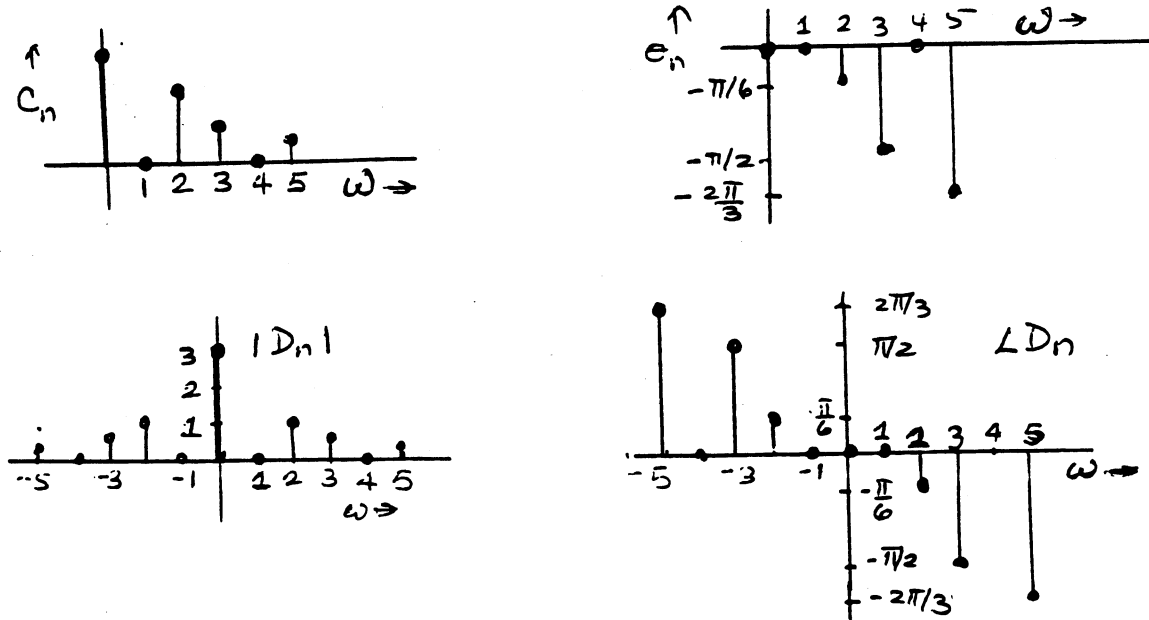

Fig. S3.5-2

3.5-3 (a) The exponential Fourier series can be expressed with coefficients in Polar form as

$$f(t) = (2\sqrt{2}e^{j\pi/4})e^{-j3t} + 2e^{j\pi/2}e^{-jt} + 3 + 2e^{-j\pi/2}e^{jt} + (2\sqrt{2}e^{-j\pi/4})e^{j3t}$$

From this expression the exponential Spectra are sketched as shown in Fig. S3.5-3a.

(b) By inspection of the exponential spectra in Fig. S3.5-3a, we sketch the trigonometric spectra as shown in Fig. S3.5-3b. From these spectra, we can write the compact trigonometric Fourier series as

$$f(t) = 3 + 4 \cos\left(t - \frac{\pi}{2}\right) + 4\sqrt{2} \cos\left(3t - \frac{\pi}{4}\right)$$

(c) The lowest frequency in the spectrum is 0 and the highest frequency is 3. Therefore the bandwidth is 3 rad/s or  $\frac{3}{2\pi}$  Hz.

3.5-4 (a)

$$f(t) = \sum_{n=-\infty}^{\infty} D_n e^{jn\omega_0 t}$$

$$\hat{f}(t) = f(t - T) = \sum_{n=-\infty}^{\infty} D_n e^{jn\omega_0(t-T)} = \sum_{n=-\infty}^{\infty} (D_n e^{-jn\omega_0 T}) e^{jn\omega_0 t} = \sum_{n=-\infty}^{\infty} \hat{D}_n e^{jn\omega_0 t}$$

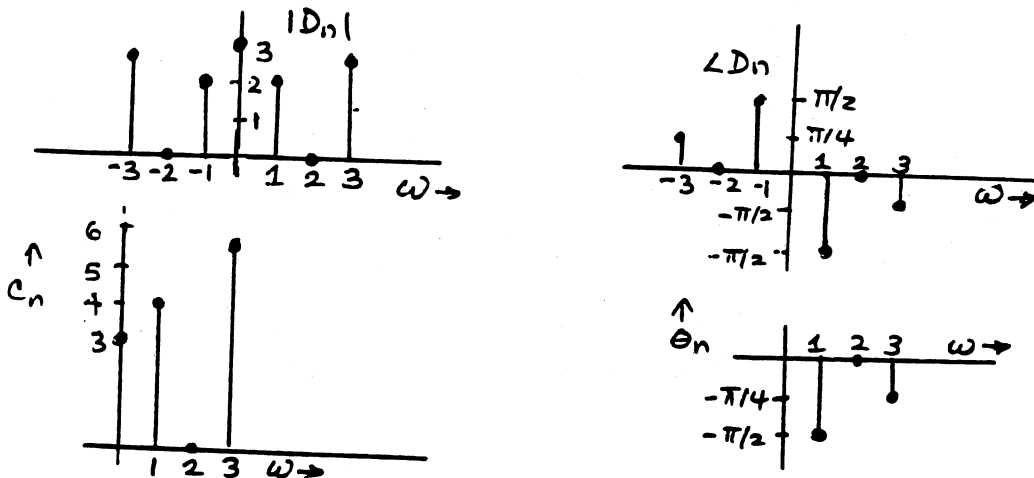

Fig. S3.5-3

$$\hat{D}_n = D_n e^{-jn\omega_0 t} \quad \text{so that} \quad |\hat{D}_n| = |D_n|, \quad \text{and} \quad \angle \hat{D}_n = \angle D_n - jn\omega_0 T$$

(b)

$$f(t) = \sum_{n=-\infty}^{\infty} D_n e^{jn\omega_0 t}$$

$$\hat{f}(t) = f(at) = \sum_{n=-\infty}^{\infty} D_n e^{jn\omega_0(at)}$$

3.5-5 (a) From Exercise E3.6a

$$f(t) = \frac{1}{3} + \frac{4}{\pi^2} \sum_{n=1}^{\infty} \frac{(-1)^n}{n^2} \cos n\pi t \quad -1 \leq t \leq 1$$

The power of  $f(t)$  is

$$P_f = \frac{1}{2} \int_{-1}^1 t^4 dt = \frac{1}{5}$$

Moreover, from Parseval's theorem [Eq. (3.82)]

$$P_f = C_0^2 + \sum_1^{\infty} \frac{C_n^2}{2} = \left(\frac{1}{3}\right)^2 + \frac{1}{2} \sum_{n=1}^{\infty} \left(\frac{4(-1)^n}{\pi^2 n^2}\right)^2 = \frac{1}{9} + \frac{8}{\pi^4} \sum_{n=1}^{\infty} \frac{1}{n^4} = \frac{1}{9} + \frac{8}{90} = \frac{1}{5}$$

(b) If the  $N$ -term Fourier series is denoted by  $x(t)$ , then

$$x(t) = \frac{1}{3} + \frac{4}{\pi^2} \sum_{n=1}^{N-1} \frac{(-1)^n}{n^2} \cos n\pi t \quad -1 \leq t \leq 1$$

The power  $P_x$  is required to be  $99\%P_f = 0.198$ . Therefore

$$P_x = \frac{1}{9} + \frac{8}{\pi^4} \sum_{n=1}^{N-1} \frac{1}{n^4} = 0.198$$

For  $N = 1$ ,  $P_x = 0.1111$ ; for  $N = 2$ ,  $P_x = 0.19323$ , For  $N = 3$ ,  $P_x = 0.19837$ , which is greater than 0.198. Thus,  $N = 3$ .

3.5-6 (a) From Exercise E3.6b

$$f(t) = \frac{2A}{\pi} (-1)^{n+1} \sum_{n=1}^{\infty} \frac{1}{n} \sin n\pi t \quad -\pi \leq t \leq \pi$$



The power of  $f(t)$  is

$$P_f = \frac{1}{2} \int_{-1}^1 (At)^2 dt = \frac{A^2}{3}$$

Moreover, from Parseval's theorem [Eq. (3.82)]

$$P_f = C_0^2 + \sum_1^{\infty} \frac{C_n^2}{2} = \frac{1}{2} \sum_1^{\infty} \frac{4A^2}{\pi^2 n^2} = \frac{2A^2}{\pi^2} \sum_1^{\infty} \frac{1}{n^2} = \frac{A^2}{3}$$

(b) If the  $N$ -term Fourier series is denoted by  $x(t)$ , then

$$x(t) = \frac{2A}{\pi} (-1)^{n+1} \sum_{n=1}^N \frac{1}{n} \sin n\pi t \quad -\pi \leq t \leq \pi$$

The power  $P_x$  is required to be  $0.90 \frac{A^2}{3} = 0.3A^2$ . Therefore

$$P_x = \frac{1}{2} \sum_1^N \frac{4A^2}{\pi^2 n^2} = 0.3A^2$$

For  $N = 1$ ,  $P_x = 0.2026A^2$ ; for  $N = 2$ ,  $P_x = 0.2533A^2$ , for  $N = 5$ ,  $P_x = 0.29658A^2$ , for  $N = 6$ ,  $P_x = 0.30222A^2$ , which is greater than  $0.3A^2$ . Thus,  $N = 6$ .

**3.5-7** The power of a rectified sine wave is the same as that of a sine wave, that is,  $1/2$ . Thus  $P_f = 0.5$ . Let the  $2N + 1$  term truncated Fourier series be denoted by  $\hat{f}(t)$ . The power  $P_{\hat{f}}$  is required to be  $0.9975P_f = 0.49875$ . Using the Fourier series coefficients in Exercise E3.10, we have

$$P_{\hat{f}} = \sum_{n=-N}^N |D_n|^2 = \frac{4}{\pi^2} \sum_{n=-N}^N \frac{1}{(1-4n^2)^2} = 0.49875$$

Direct calculations using the above equation gives  $P_{\hat{f}} = 4/\pi^2 = 0.4053$  for  $N = 0$  (only dc),  $P_{\hat{f}} = 0.49535$  for  $N = 1$  (3 terms), and  $P_{\hat{f}} = 0.49895$  for  $N = 2$  (5 terms).

Thus, a 5-term Fourier series yields a signal whose power is 99.79% of the power of the rectified sine wave. The power of the error in the approximation of  $f(t)$  by  $\hat{f}(t)$  is only 0.21% of the signal power  $P_f$ .

**3.6-1** Period  $T_0 = \pi$ , and  $\omega_0 = 2$ , and

$$H(j\omega) = \frac{j\omega}{(-\omega^2 + 3) + j2\omega}, \quad \text{and from Eq. (3.74)} \quad D_n = \frac{0.504}{1 + j4n}$$

$$\text{Therefore, } y(t) = \sum_{n=-\infty}^{\infty} D_n H(jn\omega_0) e^{jn\omega_0 t} = \sum_{n=-\infty}^{\infty} \frac{j1.08n}{(1 + j4n)(-\omega^2 + 3 + j2\omega)} e^{j2nt}$$

# Chapter 4

---

4.1-1

$$F(\omega) = \int_{-\infty}^{\infty} f(t)e^{-j\omega t} dt = \int_{-\infty}^{\infty} f(t) \cos \omega t dt - j \int_{-\infty}^{\infty} f(t) \sin \omega t dt$$

If  $f(t)$  is an even function of  $t$ ,  $f(t) \sin \omega t$  is an odd function of  $t$ , and the second integral vanishes. Moreover,  $f(t) \cos \omega t$  is an even function of  $t$ , and the first integral is twice the integral over the interval 0 to  $\infty$ . Thus when  $f(t)$  is even

$$F(\omega) = 2 \int_0^{\infty} f(t) \cos \omega t dt \quad (1)$$

Similar argument shows that when  $f(t)$  is odd

$$F(\omega) = -2j \int_0^{\infty} f(t) \sin \omega t dt \quad (2)$$

If  $f(t)$  is also real (in addition to being even), the integral (1) is real. Moreover from (1)

$$F(-\omega) = 2 \int_0^{\infty} f(t) \cos \omega t dt = F(\omega)$$

Hence  $F(\omega)$  is real and even function of  $\omega$ . Similar arguments can be used to prove the rest of the properties.

4.1-2

$$\begin{aligned} f(t) &= \frac{1}{2\pi} \int_{-\infty}^{\infty} F(\omega) e^{j\omega t} d\omega = \frac{1}{2\pi} \int_{-\infty}^{\infty} |F(\omega)| e^{j\angle F(\omega)} e^{j\omega t} d\omega \\ &= \frac{1}{2\pi} \left[ \int_{-\infty}^{\infty} |F(\omega)| \cos[\omega t + \angle F(\omega)] d\omega + j \int_{-\infty}^{\infty} |F(\omega)| \sin[\omega t + \angle F(\omega)] d\omega \right] \end{aligned}$$

Since  $|F(\omega)|$  is an even function and  $\angle F(\omega)$  is an odd function of  $\omega$ , the integrand in the second integral is an odd function of  $\omega$ , and therefore vanishes. Moreover the integrand in the first integral is an even function of  $\omega$ , and therefore

$$f(t) = \frac{1}{\pi} \int_0^{\infty} |F(\omega)| \cos[\omega t + \angle F(\omega)] d\omega$$

4.1-3 Because  $f(t) = f_o(t) + f_e(t)$  and  $e^{-j\omega t} = \cos \omega t + j \sin \omega t$

$$F(\omega) = \int_{-\infty}^{\infty} [f_o(t) + f_e(t)] e^{-j\omega t} dt = \int_{-\infty}^{\infty} [f_o(t) + f_e(t)] \cos \omega t dt - j \int_{-\infty}^{\infty} [f_o(t) + f_e(t)] \sin \omega t dt$$

Because  $f_e(t) \cos \omega t$  and  $f_o(t) \sin \omega t$  are even functions and  $f_o(t) \cos \omega t$  and  $f_e(t) \sin \omega t$  are odd functions of  $t$ , these integrals [properties in Eqs. (B.43), p. 38] reduce to

$$F(\omega) = 2 \int_0^{\infty} f_e(t) \cos \omega t dt - 2j \int_0^{\infty} f_o(t) \sin \omega t dt \quad (1)$$

Also, from the results of Prob. 4.1-1, we have

$$\mathcal{F}\{f_e(t)\} = 2 \int_0^{\infty} f_e(t) \cos \omega t dt \quad \text{and} \quad \mathcal{F}\{f_o(t)\} = -2j \int_0^{\infty} f_o(t) \sin \omega t dt \quad (2)$$

From Eqs. (1) and (2), the desired result follows.

4.1-4 (a)

$$F(\omega) = \int_0^T e^{-at} e^{-j\omega t} dt = \int_0^T e^{-(j\omega+a)t} dt = \frac{1 - e^{-(j\omega+a)T}}{j\omega + a}$$

(b)

$$F(\omega) = \int_0^T e^{at} e^{-j\omega t} dt = \int_0^T e^{-(j\omega-a)t} dt = \frac{1 - e^{-(j\omega-a)T}}{j\omega - a}$$

4.1-5 (a)

$$F(\omega) = \int_0^1 4e^{-j\omega t} dt + \int_1^2 2e^{-j\omega t} dt = \frac{4 - 2e^{-j\omega} - 2e^{-j2\omega}}{j\omega}$$

(b)

$$F(\omega) = \int_{-\tau}^0 -\frac{t}{\tau} e^{-j\omega t} dt + \int_0^{\tau} \frac{t}{\tau} e^{-j\omega t} dt = \frac{2}{\tau\omega^2} [\cos \omega\tau + \omega\tau \sin \omega\tau - 1]$$

This result could also be derived by observing that  $f(t)$  is an even function. Therefore from the result in Prob. 4.1-1

$$F(\omega) = \frac{2}{\tau} \int_0^{\tau} t \cos \omega t dt = \frac{2}{\tau\omega^2} [\cos \omega\tau + \omega\tau \sin \omega\tau - 1]$$

4.1-6 (a)

$$f(t) = \frac{1}{2\pi} \int_{-\omega_0}^{\omega_0} \omega^2 e^{j\omega t} d\omega = \frac{1}{2\pi} \frac{e^{j\omega t}}{(jt)^3} [-\omega^2 t^2 - 2j\omega t + 2] \Big|_{-\omega_0}^{\omega_0} = \frac{(\omega_0^2 t^2 - 2) \sin \omega_0 t + 2\omega_0 t \cos \omega_0 t}{\pi t^3}$$

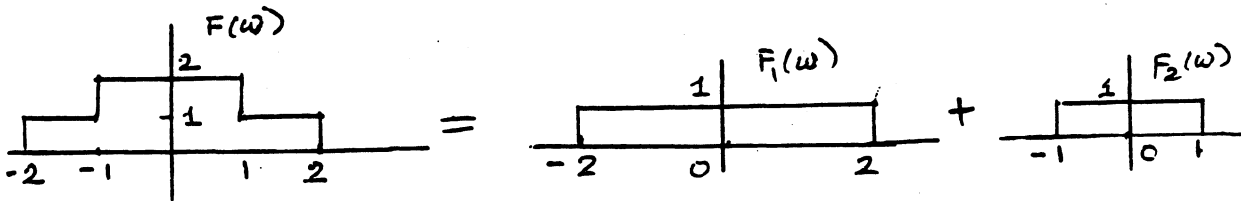

Fig. S4.1-6b

(b) The derivation can be simplified by observing that  $F(\omega)$  can be expressed as a sum of two gate functions  $F_1(\omega)$  and  $F_2(\omega)$  as shown in Fig. S4.1-6. Therefore

$$f(t) = \frac{1}{2\pi} \int_{-2}^2 [F_1(\omega) + F_2(\omega)] e^{j\omega t} d\omega = \frac{1}{2\pi} \left\{ \int_{-2}^2 e^{j\omega t} d\omega + \int_{-1}^1 e^{j\omega t} d\omega \right\} = \frac{\sin 2t + \sin t}{\pi t}$$

4.1-7 (a)

$$\begin{aligned} f(t) &= \frac{1}{2\pi} \int_{-\pi/2}^{\pi/2} \cos \omega e^{j\omega t} d\omega \\ &= \frac{e^{j\omega t}}{2\pi(1-t^2)} \{jt \cos \omega + \sin \omega\} \Big|_{-\pi/2}^{\pi/2} \\ &= \frac{1}{\pi(1-t^2)} \cos \left( \frac{\pi t}{2} \right) \end{aligned}$$

(b)

$$f(t) = \frac{1}{2\pi} \int_{-\pi/2}^{\pi/2} F(\omega) e^{j\omega t} d\omega = \frac{1}{2\pi} \left[ \int_{-\pi/2}^{\pi/2} F(\omega) \cos \omega t d\omega + j \int_{-\pi/2}^{\pi/2} F(\omega) \sin \omega t d\omega \right]$$

Because  $F(\omega)$  is even function, the second integral on the right-hand side vanishes. Also the integrand of the first term is an even function. Therefore

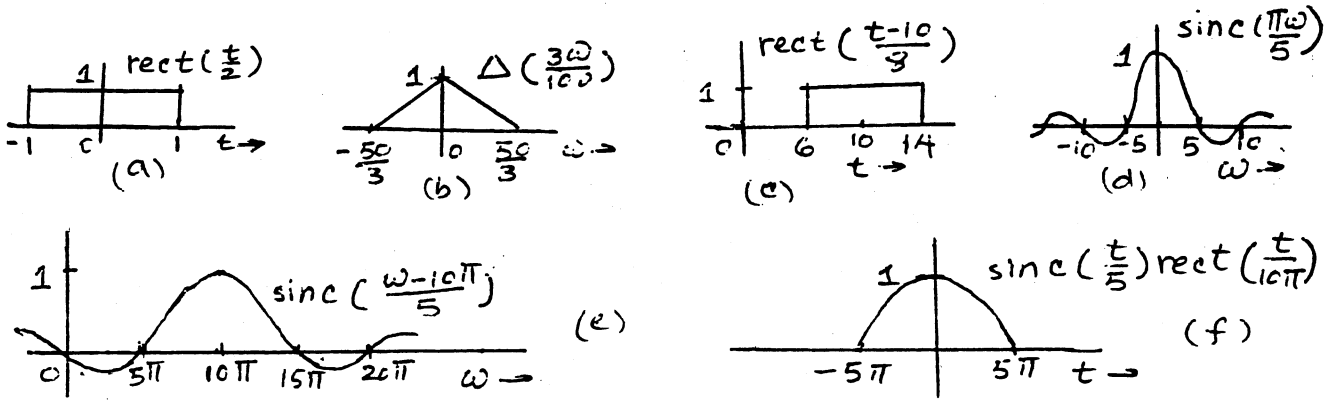

Fig. S4.2-1

$$\begin{aligned}
 f(t) &= \frac{1}{\pi} \int_0^{\omega_0} \frac{\omega}{\omega_0} \cos t\omega \, d\omega = \frac{1}{\pi\omega_0} \left[ \frac{\cos t\omega + t\omega \sin t\omega}{t^2} \right]_0^{\omega_0} \\
 &= \frac{1}{\pi\omega_0 t^2} [\cos \omega_0 t + \omega_0 t \sin \omega_0 t - 1]
 \end{aligned}$$

4.2-1 Figure S4.2-1 shows the plots of various functions. The function in part (a) is a gate function centered at the origin and of width 2. The function in part (b) can be expressed as  $\Delta\left(\frac{\omega}{100/3}\right)$ . This is a triangle pulse centered at the origin and of width  $100/3$ . The function in part (c) is a gate function  $\text{rect}\left(\frac{t}{8}\right)$  delayed by 10. In other words it is a gate pulse centered at  $t = 10$  and of width 8. The function in part (d) is a sinc pulse centered at the origin and the first zero occurring at  $\frac{\pi\omega}{5} = \pi$ , that is at  $\omega = 5$ . The function in part (e) is a sinc pulse  $\text{sinc}\left(\frac{\omega}{5}\right)$  delayed by  $10\pi$ . For the sinc pulse  $\text{sinc}\left(\frac{\omega}{5}\right)$ , the first zero occurs at  $\frac{\omega}{5} = \pi$ , that is at  $\omega = 5\pi$ . Therefore the function is a sinc pulse centered at  $\omega = 10\pi$  and its zeros spaced at intervals of  $5\pi$  as shown in the fig. S4.2-1e. The function in part (f) is a product of a gate pulse (centered at the origin) of width  $10\pi$  and a sinc pulse (also centered at the origin) with zeros spaced at intervals of  $5\pi$ . This results in the sinc pulse truncated beyond the interval  $\pm 5\pi$  ( $|t| \geq 5\pi$ ) as shown in Fig. f.

4.2-2

$$\begin{aligned}
 F(\omega) &= \int_{4.5}^{5.5} e^{-j\omega t} \, dt = -\frac{1}{j\omega} e^{-j\omega t} \Big|_{4.5}^{5.5} = \frac{1}{j\omega} [e^{-j4.5\omega} - e^{-j5.5\omega}] \\
 &= \frac{e^{-j5\omega}}{j\omega} [e^{j\omega/2} - e^{-j\omega/2}] = \frac{e^{-j5\omega}}{j\omega} [2j \sin \frac{\omega}{2}] \\
 &= \text{sinc}\left(\frac{\omega}{2}\right) e^{-j5\omega}
 \end{aligned}$$

4.2-3

$$\begin{aligned}
 f(t) &= \frac{1}{2\pi} \int_{10-\pi}^{10+\pi} e^{j\omega t} \, d\omega = \frac{e^{j\omega t}}{2\pi(j\omega)} \Big|_{10-\pi}^{10+\pi} = \frac{1}{j2\pi\omega} [e^{j(10+\pi)t} - e^{j(10-\pi)t}] \\
 &= \frac{e^{j10t}}{j2\pi\omega} [2j \sin \pi t] = \text{sinc}(\pi t) e^{j10t}
 \end{aligned}$$

4.2-4 (a)

$$\begin{aligned}
 f(t) &= \frac{1}{2\pi} \int_{-\omega_0}^{\omega_0} e^{-j\omega t_0} e^{j\omega t} \, d\omega = \frac{1}{2\pi} \int_{-\omega_0}^{\omega_0} e^{j\omega(t-t_0)} \, d\omega \\
 &= \frac{1}{(2\pi)j(t-t_0)} e^{j\omega(t-t_0)} \Big|_{-\omega_0}^{\omega_0} = \frac{\sin \omega_0(t-t_0)}{\pi(t-t_0)} = \frac{\omega_0}{\pi} \text{sinc}[\omega_0(t-t_0)]
 \end{aligned}$$

(b)

$$\begin{aligned}
 f(t) &= \frac{1}{2\pi} \left[ \int_{-\omega_0}^0 j e^{j\omega t} \, d\omega + \int_0^{\omega_0} -j e^{j\omega t} \, d\omega \right] \\
 &= \frac{1}{2\pi t} e^{j\omega t} \Big|_{-\omega_0}^0 - \frac{1}{2\pi t} e^{j\omega t} \Big|_0^{\omega_0} = \frac{1 - \cos \omega_0 t}{\pi t}
 \end{aligned}$$

4.3-1 (a)

$$\underbrace{u(t)}_{f(t)} \iff \underbrace{\pi\delta(\omega) + \frac{1}{j\omega}}_{F(\omega)}$$

Application of duality property yields

$$\underbrace{\pi\delta(t) + \frac{1}{jt}}_{F(t)} \iff \underbrace{2\pi u(-\omega)}_{2\pi f(-\omega)}$$

or

$$\frac{1}{2} \left[ \delta(t) + \frac{1}{j\pi t} \right] \iff u(-\omega)$$

Application of Eq. (4.35) yields

$$\frac{1}{2} \left[ \delta(-t) - \frac{1}{j\pi t} \right] \iff u(\omega)$$

But  $\delta(t)$  is an even function, that is  $\delta(-t) = \delta(t)$ , and

$$\frac{1}{2} \left[ \delta(t) + \frac{j}{\pi t} \right] \iff u(\omega)$$

(b)

$$\underbrace{\cos \omega_0 t}_{f(t)} \iff \underbrace{\pi[\delta(\omega + \omega_0) + \delta(\omega - \omega_0)]}_{F(\omega)}$$

Application of duality property yields

$$\underbrace{\pi[\delta(t + \omega_0) + \delta(t - \omega_0)]}_{F(t)} \iff \underbrace{2\pi \cos(-\omega_0\omega)}_{2\pi f(-\omega)} = 2\pi \cos(\omega_0\omega)$$

Setting  $\omega_0 = T$  yields

$$\delta(t + T) + \delta(t - T) \iff 2 \cos T\omega$$

(c)

$$\underbrace{\sin \omega_0 t}_{f(t)} \iff \underbrace{j\pi[\delta(\omega + \omega_0) - \delta(\omega - \omega_0)]}_{F(\omega)}$$

Application of duality property yields

$$\underbrace{j\pi[\delta(t + \omega_0) - \delta(t - \omega_0)]}_{F(t)} \iff \underbrace{2\pi \sin(-\omega_0\omega)}_{2\pi f(-\omega)} = -2\pi \sin(\omega_0\omega)$$

Setting  $\omega_0 = T$  yields

$$\delta(t + T) - \delta(t - T) \iff 2j \sin T\omega$$

4.3-2 Fig. (b)  $f_1(t) = f(-t)$  and

$$F_1(\omega) = F(-\omega) = \frac{1}{\omega^2} [e^{-j\omega} + j\omega e^{-j\omega} - 1]$$

Fig. (c)  $f_2(t) = f(t-1) + f_1(t-1)$ . Therefore

$$\begin{aligned} F_3(\omega) &= [F(\omega) + F_1(\omega)]e^{-j\omega} = [F(\omega) + F(-\omega)]e^{-j\omega} \\ &= \frac{2e^{-j\omega}}{\omega^2} (\cos \omega + \omega \sin \omega - 1) \end{aligned}$$

Fig. (d)  $f_3(t) = f(t-1) + f_1(t+1)$

$$\begin{aligned} F_4(\omega) &= F(\omega)e^{-j\omega} + F(-\omega)e^{j\omega} \\ &= \frac{1}{\omega^2} [2 - 2\cos \omega] = \frac{4}{\omega^2} \sin^2 \frac{\omega}{2} = \text{sinc}^2 \left( \frac{\omega}{2} \right) \end{aligned}$$

**Fig. (e)**  $f_4(t) = f(t - \frac{1}{2}) + f_1(t + \frac{1}{2})$ , and

$$\begin{aligned} F_4(\omega) &= F(\omega)e^{-j\omega/2} + F_1(\omega)e^{j\omega/2} \\ &= \frac{e^{-j\omega/2}}{\omega^2} [e^{j\omega} - j\omega e^{j\omega} - 1] + \frac{e^{j\omega/2}}{\omega^2} [e^{-j\omega} + j\omega e^{-j\omega} - 1] \\ &= \frac{1}{\omega^2} [2\omega \sin \frac{\omega}{2}] = \text{sinc} \left( \frac{\omega}{2} \right) \end{aligned}$$

**Fig. (f)**  $f_5(t)$  can be obtained in three steps: (i) time-expanding  $f(t)$  by a factor 2 (ii) then delaying it by 2 seconds, (iii) and multiplying it by 1.5 [we may interchange the sequence for steps (i) and (ii)]. The first step (time-expansion by a factor 2) yields

$$f \left( \frac{t}{2} \right) \iff 2F(2\omega) = \frac{1}{2\omega^2} (e^{j2\omega} - j2\omega e^{j2\omega} - 1)$$

Second step of time delay of 2 secs. yields

$$f \left( \frac{t-2}{2} \right) \iff \frac{1}{2\omega^2} (e^{j2\omega} - j2\omega e^{j2\omega} - 1) e^{-j2\omega} = \frac{1}{2\omega^2} (1 - j2\omega - e^{-j2\omega})$$

The third step of multiplying the resulting signal by 1.5 yields

$$f_5(t) = 1.5f \left( \frac{t-2}{2} \right) \iff \frac{3}{4\omega^2} (1 - j2\omega - e^{-j2\omega})$$

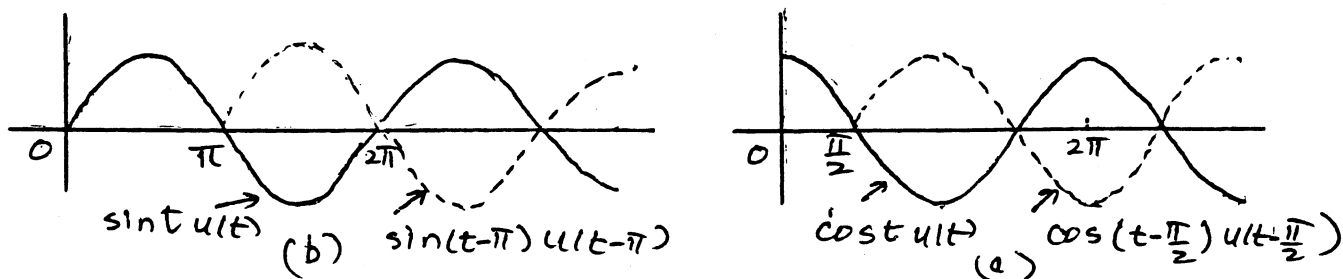

**Fig. S4.3-3**

**4.3-3 (a)**

$$\begin{aligned} f(t) &= \text{rect} \left( \frac{t+T/2}{T} \right) - \text{rect} \left( \frac{t-T/2}{T} \right) \\ \text{rect} \left( \frac{t}{T} \right) &\iff T \text{sinc} \left( \frac{\omega T}{2} \right) \\ \text{rect} \left( \frac{t \pm T/2}{T} \right) &\iff T \text{sinc} \left( \frac{\omega T}{2} \right) e^{\pm j\omega T/2} \end{aligned}$$

and

$$\begin{aligned} F(\omega) &= T \text{sinc} \left( \frac{\omega T}{2} \right) [e^{j\omega T/2} - e^{-j\omega T/2}] \\ &= 2jT \text{sinc} \left( \frac{\omega T}{2} \right) \sin \frac{\omega T}{2} \\ &= \frac{j^4}{\omega} \sin^2 \left( \frac{\omega T}{2} \right) \end{aligned}$$

**(b)** From Fig. S4.3-3b we verify that

$$f(t) = \sin t u(t) + \sin(t - \pi) u(t - \pi)$$

Note that  $\sin(t - \pi) u(t - \pi)$  is  $\sin t u(t)$  delayed by  $\pi$ . Now,  $\sin t u(t) \iff \frac{\pi}{2j} [\delta(\omega - 1) - \delta(\omega + 1)] + \frac{1}{1 - \omega^2}$  and

$$\sin(t - \pi) u(t - \pi) \iff \left\{ \frac{\pi}{2j} [\delta(\omega - 1) - \delta(\omega + 1)] + \frac{1}{1 - \omega^2} \right\} e^{-j\pi\omega}$$

Therefore

$$F(\omega) = \left\{ \frac{\pi}{2j} [\delta(\omega - 1) - \delta(\omega + 1)] + \frac{1}{1 - \omega^2} \right\} (1 + e^{-j\pi\omega})$$

Recall that  $f(x)\delta(x - x_0) = f(x_0)\delta(x - x_0)$ . Therefore  $\delta(\omega \pm 1)(1 + e^{-j\pi\omega}) = 0$ , and

$$F(\omega) = \frac{1}{1 - \omega^2} (1 + e^{-j\pi\omega})$$

(c) From Fig. S4.3-3c we verify that

$$f(t) = \cos t \left[ u(t) - u\left(t - \frac{\pi}{2}\right) \right] = \cos t u(t) - \cos t u\left(t - \frac{\pi}{2}\right)$$

But  $\sin\left(t - \frac{\pi}{2}\right) = -\cos t$ . Therefore

$$f(t) = \cos t u(t) + \sin\left(t - \frac{\pi}{2}\right) u\left(t - \frac{\pi}{2}\right)$$

$$F(\omega) = \frac{\pi}{2} [\delta(\omega - 1) + \delta(\omega + 1)] + \frac{j\omega}{1 - \omega^2} + \left\{ \frac{\pi}{2j} [\delta(\omega - 1) - \delta(\omega + 1)] + \frac{1}{1 - \omega^2} \right\} e^{-j\pi\omega/2}$$

Also because  $f(x)\delta(x - x_0) = f(x_0)\delta(x - x_0)$ ,

$$\delta(\omega \pm 1)e^{-j\pi\omega/2} = \delta(\omega \pm 1)e^{\pm j\pi/2} = \pm j\delta(\omega \pm 1)$$

Therefore

$$F(\omega) = \frac{j\omega}{1 - \omega^2} + \frac{e^{-j\pi\omega/2}}{1 - \omega^2} = \frac{1}{1 - \omega^2} [j\omega + e^{-j\pi\omega/2}]$$

(d)

$$f(t) = e^{-at} [u(t) - u(t - T)] = e^{-at} u(t) - e^{-at} u(t - T)$$

$$= e^{-at} u(t) - e^{-aT} e^{-a(t-T)} u(t - T)$$

$$F(\omega) = \frac{1}{j\omega + a} - \frac{e^{-aT}}{j\omega + a} e^{-j\omega T} = \frac{1}{j\omega + a} [1 - e^{-(a+j\omega)T}]$$

#### 4.3-4 From time-shifting property

$$f(t \pm T) \iff F(\omega)e^{\pm j\omega T}$$

Therefore

$$f(t + T) + f(t - T) \iff F(\omega)e^{j\omega T} + F(\omega)e^{-j\omega T} = 2F(\omega) \cos \omega T$$

We can use this result to derive transforms of signals in Fig. P4.3-4.

(a) Here  $f(t)$  is a gate pulse as shown in Fig. S4.3-4a.

$$f(t) = \text{rect}\left(\frac{t}{2}\right) \iff 2 \text{sinc}(\omega)$$

Also  $T = 3$ . The signal in Fig. P4.3-4a is  $f(t + 3) + f(t - 3)$ , and

$$f(t + 3) + f(t - 3) \iff 4 \text{sinc}(\omega) \cos 3\omega$$

(b) Here  $f(t)$  is a triangular pulse shown in Fig. S4.3-4b. From the Table 4.1 (pair 19)

$$f(t) = \Delta\left(\frac{t}{2}\right) \iff \text{sinc}^2\left(\frac{\omega}{2}\right)$$

Also  $T = 3$ . The signal in Fig. P4.3-4b is  $f(t + 3) + f(t - 3)$ , and

$$f(t + 3) + f(t - 3) \iff 2 \text{sinc}^2\left(\frac{\omega}{2}\right) \cos 3\omega$$

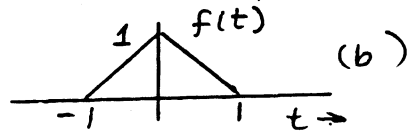
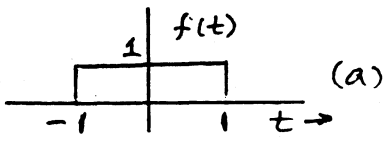

Fig. S4.3-4

4.3-5 Frequency-shifting property states that

$$f(t)e^{\pm j\omega_0 t} \Leftrightarrow F(\omega \mp \omega_0)$$

Therefore

$$f(t) \sin \omega_0 t = \frac{1}{2j} [f(t)e^{j\omega_0 t} + f(t)e^{-j\omega_0 t}] = \frac{1}{2j} [F(\omega - \omega_0) + F(\omega + \omega_0)]$$

Time-shifting property states that

$$f(t \pm T) \Leftrightarrow F(\omega)e^{\pm j\omega T}$$

Therefore

$$f(t+T) - f(t-T) \Leftrightarrow F(\omega)e^{j\omega T} - F(\omega)e^{-j\omega T} = 2jF(\omega) \sin \omega T$$

and

$$\frac{1}{2j} [f(t+T) - f(t-T)] \Leftrightarrow F(\omega) \sin T\omega$$

The signal in Fig. P4.3-5 is  $f(t+3) - f(t-3)$  where

$$f(t) = \text{rect}\left(\frac{t}{2}\right) \Leftrightarrow 2\text{sinc}(\omega)$$

Therefore

$$f(t+3) - f(t-3) \Leftrightarrow 2j[2\text{sinc}(\omega) \sin 3\omega] = 4j \text{sinc}(\omega) \sin 3\omega$$

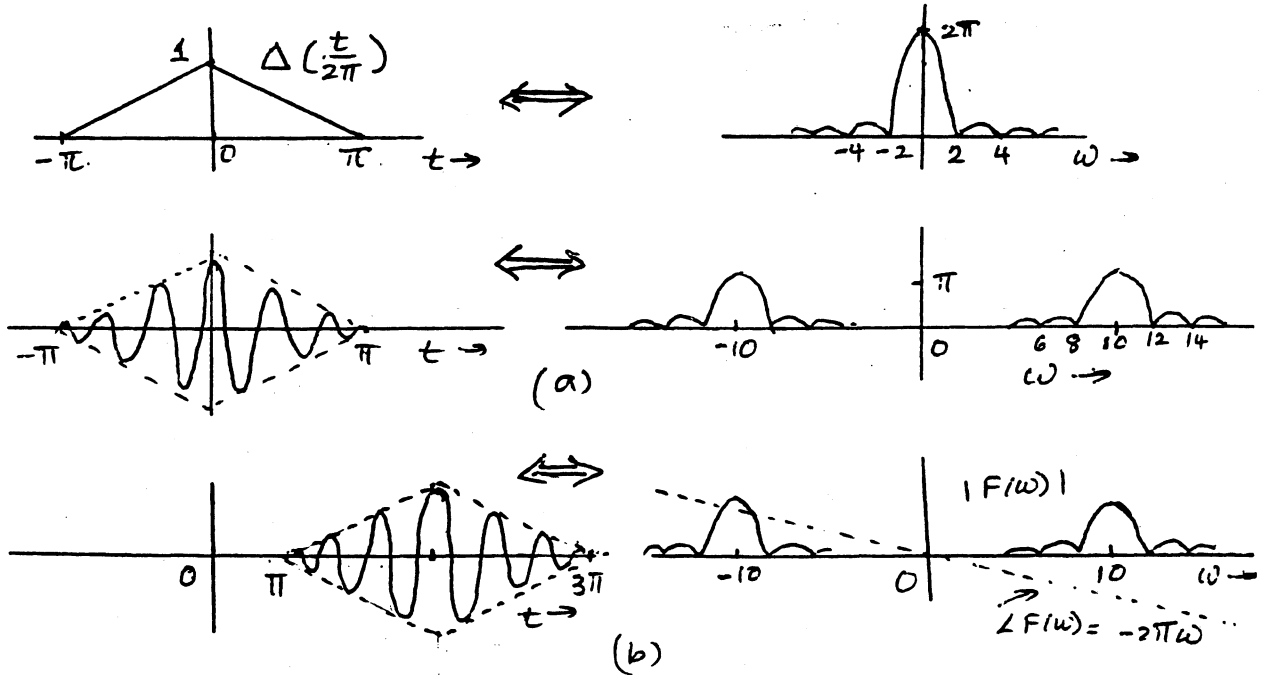

Fig. S4.3-6



**4.3-6 Fig. (a)** The signal  $f(t)$  in this case is a triangle pulse  $\Delta\left(\frac{t}{2\pi}\right)$  (Fig. S4.3-6) multiplied by  $\cos 10t$ .

$$f(t) = \Delta\left(\frac{t}{2\pi}\right) \cos 10t$$

Also from Table 4.1 (pair 19)  $\Delta\left(\frac{t}{2\pi}\right) \iff \pi \operatorname{sinc}^2\left(\frac{\pi\omega}{2}\right)$  From the modulation property (4.41), it follows that

$$f(t) = \Delta\left(\frac{t}{2\pi}\right) \cos 10t \iff \frac{\pi}{2} \left\{ \operatorname{sinc}^2\left[\frac{\pi(\omega - 10)}{2}\right] + \operatorname{sinc}^2\left[\frac{\pi(\omega + 10)}{2}\right] \right\}$$

The Fourier transform in this case is a real function and we need only the amplitude spectrum in this case as shown in Fig. S4.3-6a.

**Fig. (b)** The signal  $f(t)$  here is the same as the signal in Fig. (a) delayed by  $2\pi$ . From time shifting property, its Fourier transform is the same as in part (a) multiplied by  $e^{-j\omega(2\pi)}$ . Therefore

$$F(\omega) = \frac{\pi}{2} \left\{ \operatorname{sinc}^2\left[\frac{\pi(\omega - 10)}{2}\right] + \operatorname{sinc}^2\left[\frac{\pi(\omega + 10)}{2}\right] \right\} e^{-j2\pi\omega}$$

The Fourier transform in this case is the same as that in part (a) multiplied by  $e^{-j2\pi\omega}$ . This multiplying factor represents a linear phase spectrum  $-2\pi\omega$ . Thus we have an amplitude spectrum [same as in part (a)] as well as a linear phase spectrum  $\angle F(\omega) = -2\pi\omega$  as shown in Fig. S4.3-6b. the amplitude spectrum in this case as shown in Fig. S4.3-6b.

Note: In the above solution, we first multiplied the triangle pulse  $\Delta\left(\frac{t}{2\pi}\right)$  by  $\cos 10t$  and then delayed the result by  $2\pi$ . This means the signal in Fig. (b) is expressed as  $\Delta\left(\frac{t-2\pi}{2\pi}\right) \cos 10(t-2\pi)$ .

We could have interchanged the operation in this particular case, that is, the triangle pulse  $\Delta\left(\frac{t}{2\pi}\right)$  is first delayed by  $2\pi$  and then the result is multiplied by  $\cos 10t$ . In this alternate procedure, the signal in Fig. (b) is expressed as  $\Delta\left(\frac{t-2\pi}{2\pi}\right) \cos 10t$ .

This interchange of operation is permissible here only because the sinusoid  $\cos 10t$  executes integral number of cycles in the interval  $2\pi$ . Because of this both the expressions are equivalent since  $\cos 10(t-2\pi) = \cos 10t$ .

**Fig. (c)** In this case the signal is identical to that in Fig. b, except that the basic pulse is  $\operatorname{rect}\left(\frac{t}{2\pi}\right)$  instead of a triangle pulse  $\Delta\left(\frac{t}{2\pi}\right)$ . Now

$$\operatorname{rect}\left(\frac{t}{2\pi}\right) \iff 2\pi \operatorname{sinc}(\pi\omega)$$

Using the same argument as for part (b), we obtain

$$F(\omega) = \pi \{ \operatorname{sinc}[\pi(\omega + 10)] + \operatorname{sinc}[\pi(\omega - 10)] \} e^{-j2\pi\omega}$$

**4.3-7 (a)**

$$F(\omega) = \operatorname{rect}\left(\frac{\omega - 4}{2}\right) + \operatorname{rect}\left(\frac{\omega + 4}{2}\right)$$

Also

$$\frac{1}{\pi} \operatorname{sinc}(t) \iff \operatorname{rect}\left(\frac{\omega}{2}\right)$$

Therefore

$$f(t) = \frac{2}{\pi} \operatorname{sinc}(t) \cos 4t$$

**(b)**

$$F(\omega) = \Delta\left(\frac{\omega + 4}{4}\right) + \Delta\left(\frac{\omega - 4}{4}\right)$$

Also

$$\frac{1}{\pi} \operatorname{sinc}^2(t) \iff \Delta\left(\frac{\omega}{4}\right)$$

Therefore

$$f(t) = \frac{2}{\pi} \operatorname{sinc}^2(t) \cos 4t$$

**4.3-8 (a)**

$$e^{\lambda t} u(t) \iff \frac{1}{j\omega - \lambda} \quad \text{and} \quad u(t) \iff \pi\delta(\omega) + \frac{1}{j\omega}$$

If  $f(t) = e^{\lambda t} u(t) * u(t)$ , then

$$\begin{aligned}
F(\omega) &= \left( \frac{1}{j\omega - \lambda} \right) \left( \pi\delta(\omega) + \frac{1}{j\omega} \right) \\
&= \frac{\pi\delta(\omega)}{j\omega - \lambda} + \left[ \frac{1}{j\omega(j\omega - \lambda)} \right] \\
&= -\frac{\pi}{\lambda}\delta(\omega) + \left[ \frac{-\frac{1}{\lambda}}{j\omega} + \frac{\frac{1}{\lambda}}{j\omega - \lambda} \right] \quad \text{because } f(x)\delta(x) = f(0)\delta(x) \\
&= \frac{1}{\lambda} \left[ \frac{1}{j\omega - \lambda} - \left( \pi\delta(\omega) + \frac{1}{j\omega} \right) \right]
\end{aligned}$$

Taking the inverse transform of this equation yields

$$f(t) = \frac{1}{\lambda}(e^{\lambda t} - 1)u(t)$$

(b)

$$e^{\lambda_1 t}u(t) \iff \frac{1}{j\omega - \lambda_1} \quad \text{and} \quad e^{\lambda_2 t}u(t) \iff \frac{1}{j\omega - \lambda_2}$$

If  $f(t) = e^{\lambda_1 t}u(t) * e^{\lambda_2 t}u(t)$ , then

$$F(\omega) = \frac{1}{(j\omega - \lambda_1)(j\omega - \lambda_2)} = \frac{\frac{1}{\lambda_1 - \lambda_2}}{j\omega - \lambda_1} - \frac{\frac{1}{\lambda_1 - \lambda_2}}{j\omega - \lambda_2}$$

Therefore

$$f(t) = \frac{1}{\lambda_1 - \lambda_2}(e^{\lambda_1 t} - e^{\lambda_2 t})u(t)$$

(c)

$$e^{\lambda_1 t}u(t) \iff \frac{1}{j\omega - \lambda_1} \quad \text{and} \quad e^{\lambda_2 t}u(-t) \iff -\frac{1}{j\omega - \lambda_2}$$

If  $f(t) = e^{\lambda_1 t}u(t) * e^{\lambda_2 t}u(-t)$ , then

$$F(\omega) = \frac{-1}{(j\omega - \lambda_1)(j\omega - \lambda_2)} = \frac{\frac{1}{\lambda_2 - \lambda_1}}{j\omega - \lambda_1} - \frac{\frac{1}{\lambda_2 - \lambda_1}}{j\omega - \lambda_2}$$

Therefore

$$f(t) = \frac{1}{\lambda_2 - \lambda_1}[e^{\lambda_1 t}u(t) + e^{\lambda_2 t}u(-t)]$$

Note that because  $\lambda_2 > 0$ , the inverse transform of  $\frac{-1}{j\omega - \lambda_2}$  is  $e^{\lambda_2 t}u(-t)$  and not  $-e^{\lambda_2 t}u(t)$ . The Fourier transform of the latter does not exist because  $\lambda_2 > 0$ .

(d)

$$e^{\lambda_1 t}u(-t) \iff -\frac{1}{j\omega - \lambda_1} \quad \text{and} \quad e^{\lambda_2 t}u(-t) \iff -\frac{1}{j\omega - \lambda_2}$$

If  $f(t) = e^{\lambda_1 t}u(-t) * e^{\lambda_2 t}u(-t)$ , then

$$F(\omega) = \frac{1}{(j\omega - \lambda_1)(j\omega - \lambda_2)} = \frac{\frac{-1}{\lambda_2 - \lambda_1}}{j\omega - \lambda_1} - \frac{\frac{-1}{\lambda_2 - \lambda_1}}{j\omega - \lambda_2}$$

Therefore

$$f(t) = \frac{1}{\lambda_2 - \lambda_1}(e^{\lambda_1 t} - e^{\lambda_2 t})u(-t)$$

The remarks at the end of part (c) apply here also.

**4.3-9** From the frequency convolution property, we obtain

$$f^2(t) \iff \frac{1}{2\pi}F(\omega) * F(\omega)$$

Because of the width property of the convolution, the width of  $F(\omega) * F(\omega)$  is twice the width of  $F(\omega)$ . Repeated application of this argument shows that the bandwidth of  $f^n(t)$  is  $nB$  Hz ( $n$  times the bandwidth of  $f(t)$ ).

**4.3-10 (a)**

$$F(\omega) = \int_{-T}^0 e^{-j\omega t} dt - \int_0^T e^{-j\omega t} dt = -\frac{2}{j\omega}[1 - \cos \omega T] = \frac{j4}{\omega} \sin^2 \left( \frac{\omega T}{2} \right)$$

(b)

$$f(t) = \text{rect}\left(\frac{t+T/2}{T}\right) - \text{rect}\left(\frac{t-T/2}{T}\right)$$

$$\text{rect}\left(\frac{t}{T}\right) \iff T \text{sinc}\left(\frac{\omega T}{2}\right)$$

$$\text{rect}\left(\frac{t \pm T/2}{T}\right) \iff T \text{sinc}\left(\frac{\omega T}{2}\right) e^{\pm j\omega T/2}$$

and

$$\begin{aligned} F(\omega) &= T \text{sinc}\left(\frac{\omega T}{2}\right) [e^{j\omega T/2} - e^{-j\omega T/2}] \\ &= 2jT \text{sinc}\left(\frac{\omega T}{2}\right) \sin \frac{\omega T}{2} \\ &= \frac{j4}{\omega} \sin^2\left(\frac{\omega T}{2}\right) \end{aligned}$$

(c)

$$\frac{df}{dt} = \delta(t+T) - 2\delta(t) + \delta(t-T)$$

The Fourier transform of this equation yields

$$j\omega F(\omega) = e^{j\omega T} - 2 + e^{-j\omega T} = -2[1 - \cos \omega T] = -4 \sin^2\left(\frac{\omega T}{2}\right)$$

Therefore

$$F(\omega) = \frac{j4}{\omega} \sin^2\left(\frac{\omega T}{2}\right)$$

4.3-11

$$F(\omega) = \int_{-\infty}^{\infty} f(t)e^{-j\omega t} dt \quad \text{and} \quad \frac{dF}{d\omega} = \frac{d}{d\omega} \int_{-\infty}^{\infty} f(t)e^{-j\omega t} dt$$

Changing the order of differentiation and integration yields

$$\frac{dF}{d\omega} = \int_{-\infty}^{\infty} \frac{d}{d\omega} (f(t)e^{-j\omega t}) = \int_{-\infty}^{\infty} [-jtf(t)]e^{-j\omega t} dt$$

Therefore

$$-jtf(t) \iff \frac{dF}{d\omega}$$

(b)

$$e^{-at}u(t) \iff \frac{1}{j\omega + a}$$

$$-jte^{-at}u(t) \iff \frac{d}{d\omega} \left( \frac{1}{j\omega + a} \right) = \frac{-j}{(j\omega + a)^2}$$

and

$$te^{-at}u(t) \iff \frac{1}{(j\omega + a)^2}$$

4.4-1

$$H(\omega) = \frac{1}{j\omega + 1}$$

(a)

$$F(\omega) = \frac{1}{j\omega + 2}$$

$$Y(\omega) = \frac{1}{(j\omega + 1)(j\omega + 2)} = \frac{1}{j\omega + 1} - \frac{1}{j\omega + 2}$$

$$y(t) = (e^{-t} - e^{-2t})u(t)$$

(b)

$$F(\omega) = \frac{1}{j\omega + 1}$$
$$Y(\omega) = \frac{1}{(j\omega + 1)^2}$$
$$y(t) = te^{-at}u(t)$$

(c)

$$F(\omega) = -\frac{1}{j\omega - 1}$$
$$Y(\omega) = \frac{-1}{(j\omega + 1)(j\omega - 1)} = \frac{1/2}{j\omega + 1} - \frac{1/2}{j\omega - 1}$$
$$y(t) = \frac{1}{2}e^{-t}u(t) + \frac{1}{2}e^t u(-t)$$

(d)

$$F(\omega) = \pi\delta(\omega) + \frac{1}{j\omega}$$
$$Y(\omega) = \frac{1}{j\omega + 1} \left[ \pi\delta(\omega) + \frac{1}{j\omega} \right]$$
$$= \pi\delta(\omega) + \frac{1}{j\omega(j\omega + 1)} \quad [\text{because } f(x)\delta(x) = f(0)\delta(x)]$$
$$= \pi\delta(\omega) + \frac{1}{j\omega} - \frac{1}{j\omega + 1}$$
$$y(t) = (1 - e^{-t})u(t)$$

4.4-2 (a)

$$F(\omega) = \frac{1}{j\omega + 1} \quad \text{and} \quad H(\omega) = \frac{-1}{j\omega - 2}$$

and

$$Y(\omega) = \frac{-1}{(j\omega - 2)(j\omega + 1)} = \frac{1}{3} \left[ \frac{1}{j\omega + 1} - \frac{1}{j\omega - 2} \right]$$

Therefore

$$y(t) = \frac{1}{3} [e^{-t}u(t) + e^{2t}u(-t)]$$

(b)

$$F(\omega) = \frac{-1}{j\omega - 1} \quad \text{and} \quad H(\omega) = \frac{-1}{j\omega - 2}$$

and

$$Y(\omega) = \frac{1}{(j\omega - 1)(j\omega - 2)} = \frac{-1}{j\omega - 1} - \frac{-1}{j\omega - 2}$$

Therefore

$$y(t) = [e^t - e^{2t}]u(-t)$$

4.4-3

$$F_1(\omega) = \text{sinc}\left(\frac{\omega}{20000}\right) \quad \text{and} \quad F_2(\omega) = 1$$

Figure S4.4-3 shows  $F_1(\omega)$ ,  $F_2(\omega)$ ,  $H_1(\omega)$  and  $H_2(\omega)$ . Now

$$Y_1(\omega) = F_1(\omega)H_1(\omega)$$

$$Y_2(\omega) = F_2(\omega)H_2(\omega)$$

The spectra  $Y_1(\omega)$  and  $Y_2(\omega)$  are also shown in Fig. S4.4-3. Because  $y(t) = y_1(t)y_2(t)$ , the frequency convolution property yields  $Y(\omega) = Y_1(\omega) * Y_2(\omega)$ . From the width property of convolution, it follows that the bandwidth of

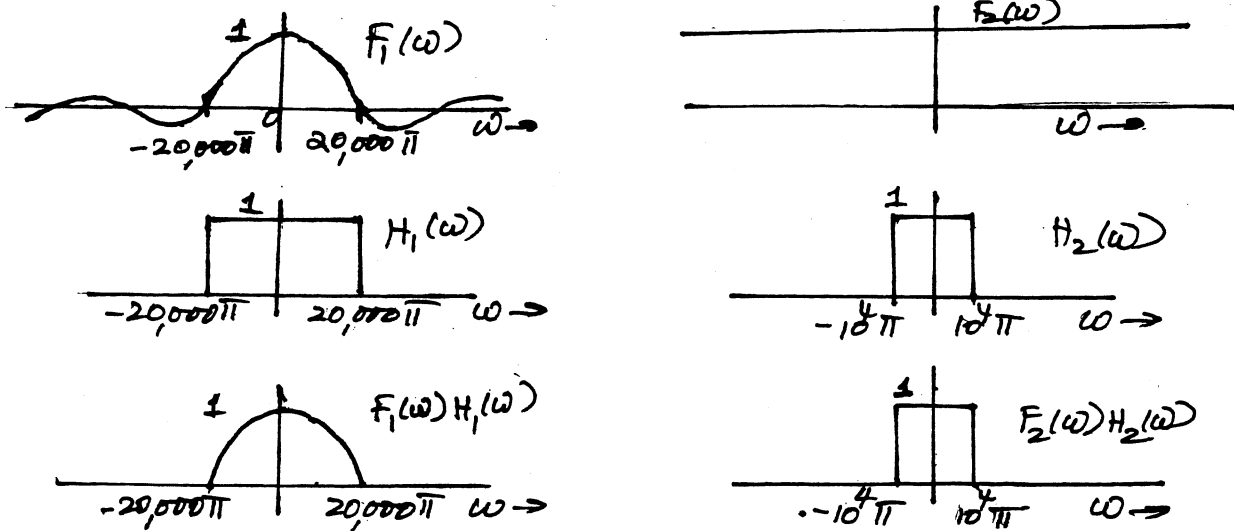

Fig. S4.4-3

$Y(\omega)$  is the sum of bandwidths of  $Y_1(\omega)$  and  $Y_2(\omega)$ . Because the bandwidths of  $Y_1(\omega)$  and  $Y_2(\omega)$  are 10 kHz, 5 kHz, respectively, the bandwidth of  $Y(\omega)$  is 15 kHz.

4.4-4

$$H(\omega) = 10^{-3} \operatorname{sinc}\left(\frac{\omega}{2000}\right) \quad \text{and} \quad P(\omega) = 0.5 \times 10^{-6} \operatorname{sinc}^2\left(\frac{\omega}{4 \times 10^6}\right)$$

The two spectra are sketched in Fig. S4.4-4. It is clear that  $H(\omega)$  is much narrower than  $P(\omega)$ , and we may consider  $P(\omega)$  to be nearly constant of value  $P(0) = 10^{-6}/2$  over the entire band of  $H(\omega)$ . Hence,

$$Y(\omega) = P(\omega)H(\omega) \approx P(0)H(\omega) = 0.5 \times 10^{-6} H(\omega) \quad \Rightarrow \quad y(t) = 0.5 \times 10^{-6} h(t)$$

Recall that  $h(t)$  is the unit impulse response of the system. Hence, the output  $y(t)$  is equal to the system response to an input  $0.5 \times 10^{-6} \delta(t) = A\delta(t)$ .

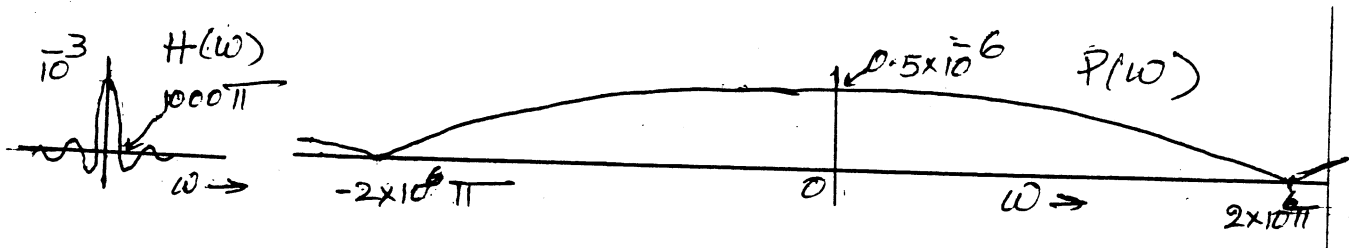

Fig. S4.4-4

4.4-5

$$H(\omega) = 10^{-3} \operatorname{sinc}\left(\frac{\omega}{2000}\right) \quad \text{and} \quad P(\omega) = 0.5 \operatorname{sinc}^2\left(\frac{\omega}{4}\right)$$

The two spectra are sketched in Fig. S4.4-5. It is clear that  $P(\omega)$  is much narrower than  $H(\omega)$ , and we may consider  $H(\omega)$  to be nearly constant of value  $H(0) = 10^{-3}$  over the entire band of  $P(\omega)$ . Hence,

$$Y(\omega) = P(\omega)H(\omega) \approx P(\omega)H(0) = 10^{-3} P(\omega) \quad \Rightarrow \quad y(t) = 10^{-3} p(t)$$

Note that the dc gain of the system is  $k = H(0) = 10^{-3}$ . Hence, the output is nearly  $kP(t)$ .

4.4-6 Every signal can be expressed as a sum of even and odd components (see Sec. 1.5-2). Hence,  $h(t)$  can be expressed as a sum of its even and odd components a

$$h(t) = h_e(t) + h_o(t)$$

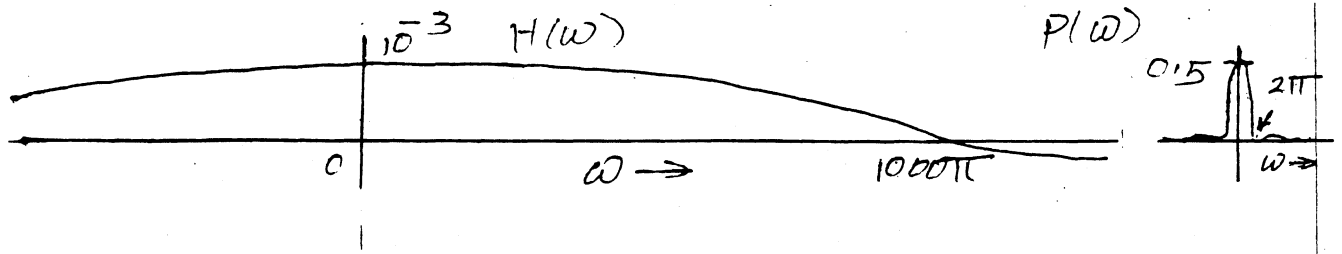

Fig. S4.4-5

where  $h_e(t) = \frac{1}{2}[h(t)u(t) + h(-t)u(-t)]$  and  $h_o(t) = \frac{1}{2}[h(t)u(t) - h(-t)u(-t)]$ . From these equations, we make an important observation that

$$h_e(t) = h_o(t) \operatorname{sgn}(t) \quad \text{and} \quad h_o(t) = h_e(t) \operatorname{sgn}(t) \quad (1)$$

provided that  $h(t)$  has no impulse at the origin. This result applies only if  $h(t)$  is causal. The graphical proof of this result may be seen in Fig. 1.24.

Moreover, we have proved in Prob. 4.1-1 that the Fourier transform of a real and even signal is a real and even function of  $\omega$ , and the Fourier transform of a real and odd signal is an imaginary odd function of  $\omega$ . Therefore, if  $F(\omega) = R(\omega) + jX(\omega)$ , then

$$h_e(t) \iff R(\omega) \quad \text{and} \quad h_o(t) \iff jX(\omega) \quad (2)$$

Applying the convolution property to Eq. (1), we obtain

$$R(\omega) = \frac{1}{2\pi} jX(\omega) * \frac{2}{j\omega} = \frac{1}{\pi} \int_{-\infty}^{\infty} \frac{X(y)}{\omega - y} dy$$

and

$$jX(\omega) = \frac{1}{2\pi} R(\omega) * \frac{2}{j\omega} = \frac{1}{j\pi} \int_{-\infty}^{\infty} \frac{R(y)}{\omega - y} dy$$

or

$$X(\omega) = -\frac{1}{\pi} \int_{-\infty}^{\infty} \frac{R(y)}{\omega - y} dy$$

#### 4.5-1

$$H(\omega) = e^{-k\omega^2} e^{-j\omega t_0}$$

Using pair 22 (Table 4.1) and time-shifting property, we get

$$h(t) = \frac{1}{\sqrt{4\pi k}} e^{-(t-t_0)^2/4k}$$

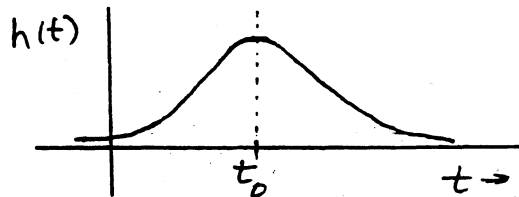

Figure S4.5-1

This is noncausal. Hence the filter is unrealizable. Also

$$\int_{-\infty}^{\infty} \frac{|\ln |H(\omega)||}{\omega^2 + 1} d\omega = \int_{-\infty}^{\infty} \frac{k\omega^2}{\omega^2 + 1} d\omega = \infty$$

Hence the filter is noncausal and therefore unrealizable. Since  $h(t)$  is a Gaussian function delayed by  $t_0$ , it looks as shown in the adjacent figure. Choosing  $t_0 = 3\sqrt{2k}$ ,  $h(0) = e^{-4.5} = 0.011$  or 1.1% of its peak value. Hence  $t_0 = 3\sqrt{2k}$  is a reasonable choice to make the filter approximately realizable.

4.5-2

$$H(\omega) = \frac{2 \times 10^5}{\omega^2 + 10^{10}} e^{-j\omega t_0}$$

From pair 3, Table 4.1 and time-shifting property, we get

$$h(t) = e^{-10^5 |t-t_0|}$$

The impulse response is noncausal, and the filter is unrealizable.

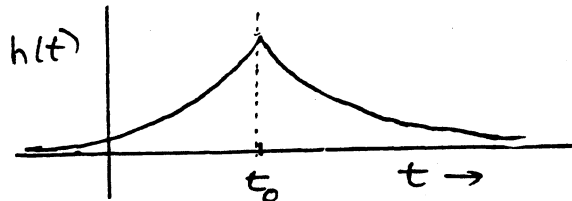

Figure S4.5-2

The exponential decays to 1.8% at 4 times constants. Hence  $t_0 = 4/a = 4 \times 10^{-5} = 40 \mu\text{s}$  is a reasonable choice to make this filter approximately realizable.

4.5-3 The unit impulse response is the inverse Fourier transform of  $H(\omega)$ . Hence, we have

$$h(t) = \text{(a) } 0.5 \text{ rect} \left( \frac{t}{2 \times 10^{-6}} \right) \quad \text{(b) } \text{sinc}^2(10,000\pi t) \quad \text{(c) } 1$$

All the three systems are noncausal (and, therefore, unrealizable) because all the three impulse responses start before  $t = 0$ .

For (a), the impulse response is a rectangular pulse starting at  $t = -10^{-6}$ . Hence, delaying the  $h(t)$  by 1  $\mu\text{second}$  will make it realizable. This will not change anything in the system behavior except the time delay of 1  $\mu\text{second}$  in the system response.

For (b), the impulse response is a sinc square pulse, which extends all the way to  $-\infty$ . Clearly, this system cannot be made realizable with a finite time delay. The delay has to be infinite. However, because the sinc square pulse decays rapidly (see Fig. 4.24d), we may truncate it at  $t = 10^{-4}$ , and then delay the resulting  $h(t)$  by  $10^{-4}$ . This makes the filter approximately realizable by allowing a time delay of 100  $\mu\text{seconds}$  in the system response.

For (c), the impulse response is 1, which never decays. Consequently, this filter cannot be realized with any amount of delay.

4.6-1

$$E_f = \int_{-\infty}^{\infty} f^2(t) dt = \frac{1}{2\pi\sigma^2} \int_{-\infty}^{\infty} e^{-t^2/\sigma^2} dt$$

Letting  $\frac{t}{\sigma} = \frac{x}{\sqrt{2}}$  and consequently  $dt = \frac{\sigma}{\sqrt{2}} dx$

$$E_f = \frac{1}{2\pi\sigma^2} \frac{\sigma}{\sqrt{2}} \int_{-\infty}^{\infty} e^{-x^2/2} dx = \frac{\sqrt{2\pi}}{2\sqrt{2}\pi\sigma} = \frac{1}{2\sigma\sqrt{\pi}}$$

Also from pair 22 (Table 4.1)

$$F(\omega) = e^{-\sigma^2\omega^2/2}$$

$$E_f = \frac{1}{2\pi} \int_{-\infty}^{\infty} |F(\omega)|^2 d\omega = \frac{1}{2\pi} \int_{-\infty}^{\infty} e^{-\sigma^2\omega^2} d\omega$$

Letting  $\sigma\omega = \frac{x}{\sqrt{2}}$  and consequently  $d\omega = \frac{1}{\sigma\sqrt{2}} dx$

$$E_f = \frac{1}{2\pi} \frac{1}{\sigma\sqrt{2}} \int_{-\infty}^{\infty} e^{-x^2/2} dx = \frac{\sqrt{2\pi}}{2\pi\sigma\sqrt{2}} = \frac{1}{2\sigma\sqrt{\pi}}$$

4.6-2 Consider a signal

$$f(t) = \text{sinc}(kt) \quad \text{and} \quad F(\omega) = \frac{\pi}{k} \text{rect}\left(\frac{\omega}{2k}\right)$$

$$\begin{aligned} E_f &= \int_{-\infty}^{\infty} \text{sinc}^2(kt) dt = \frac{1}{2\pi} \int_{-\infty}^{\infty} \frac{\pi^2}{k^2} \left[ \text{rect}\left(\frac{\omega}{2k}\right) \right]^2 d\omega \\ &= \frac{\pi}{2k^2} \int_{-k}^k d\omega = \frac{\pi}{k} \end{aligned}$$

4.6-3 If  $f^2(t) \iff A(\omega)$ , then the output  $Y(\omega) = A(\omega)H(\omega)$ , where  $H(\omega)$  is the lowpass filter transfer function (Fig. S4.4-6). Because this filter band  $\Delta\mathcal{F} \rightarrow 0$ , we may express it as an impulse function of area  $4\pi\Delta\mathcal{F}$ . Thus,

$$H(\omega) \approx [4\pi\Delta\mathcal{F}]\delta(\omega) \quad \text{and} \quad Y(\omega) \approx [4\pi A(\omega)\Delta\mathcal{F}]\delta(\omega) = [4\pi A(0)\Delta\mathcal{F}]\delta(\omega)$$

Here we used the property  $f(x)\delta(x) = f(0)\delta(x)$  [Eq. (1.23a)]. This yields

$$y(t) = 2A(0)\Delta\mathcal{F}$$

Next, because  $f^2(t) \iff A(\omega)$ , we have

$$A(\omega) = \int_{-\infty}^{\infty} f^2(t)e^{-j\omega t} dt \quad \text{so that} \quad A(0) = \int_{-\infty}^{\infty} f^2(t) dt = E_f$$

Hence,  $y(t) = 2E_f\Delta\mathcal{F}$ .

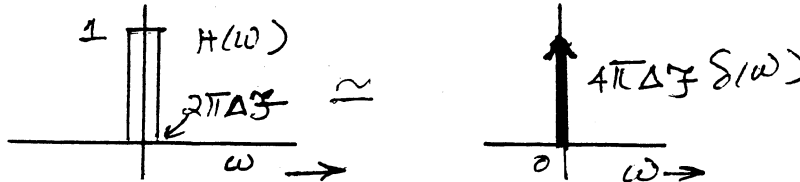

Fig. S4.6-3

4.6-4 Recall that

$$f_2(t) = \frac{1}{2\pi} \int_{-\infty}^{\infty} F_2(\omega)e^{j\omega t} d\omega \quad \text{and} \quad \int_{-\infty}^{\infty} f_1(t)e^{j\omega t} dt = F_1(-\omega)$$

Therefore

$$\begin{aligned} \int_{-\infty}^{\infty} f_1(t)f_2(t) dt &= \frac{1}{2\pi} \int_{-\infty}^{\infty} f_1(t) \left[ \int_{-\infty}^{\infty} F_2(\omega)e^{j\omega t} d\omega \right] dt \\ &= \frac{1}{2\pi} \int_{-\infty}^{\infty} F_2(\omega) \left[ \int_{-\infty}^{\infty} f_1(t)e^{j\omega t} dt \right] d\omega = \frac{1}{2\pi} \int_{-\infty}^{\infty} F_1(-\omega)F_2(\omega) d\omega \end{aligned}$$

Interchanging the roles of  $f_1(t)$  and  $f_2(t)$  in the above development, we can show that

$$\int_{-\infty}^{\infty} f_1(t)f_2(t) dt = \frac{1}{2\pi} \int_{-\infty}^{\infty} F_1(\omega)F_2(-\omega) d\omega$$

4.6-5 Application of duality property [Eq. (4.31)] to pair 3 (Table 4.1) yields

$$\frac{2a}{t^2 + a^2} \iff 2\pi e^{-a|\omega|}$$



The signal energy is given by

$$E_f = \frac{1}{\pi} \int_0^{\infty} |2\pi e^{-a\omega}|^2 d\omega = 4\pi \int_0^{\infty} e^{-2a\omega} d\omega = \frac{2\pi}{a}$$

The energy contained within the band (0 to W) is

$$E_W = 4\pi \int_0^W e^{-2a\omega} d\omega = \frac{2\pi}{a} [1 - e^{-2aW}]$$

If  $E_W = 0.99E_f$ , then

$$e^{-2aW} = 0.01 \implies W = \frac{2.3025}{a} \text{ rad/s} = \frac{0.366}{a} \text{ Hz}$$

4.7-1 (i) For  $m(t) = \cos 1000t$

$$\begin{aligned} \varphi_{\text{DSB-SC}}(t) &= m(t) \cos 10,000t = \cos 1000t \cos 10,000t \\ &= \frac{1}{2} [\underbrace{\cos 9000t}_{\text{LSB}} + \underbrace{\cos 11,000t}_{\text{USB}}] \end{aligned}$$

(ii) For  $m(t) = 2 \cos 1000t + \cos 2000t$

$$\begin{aligned} \varphi_{\text{DSB-SC}}(t) &= m(t) \cos 10,000t = [2 \cos 1000t + \cos 2000t] \cos 10,000t \\ &= \cos 9000t + \cos 11,000t + \frac{1}{2} [\cos 8000t + \cos 12,000t] \\ &= \underbrace{[\cos 9000t + \frac{1}{2} \cos 8000t]}_{\text{LSB}} + \underbrace{[\cos 11,000t + \frac{1}{2} \cos 12,000t]}_{\text{USB}} \end{aligned}$$

(iii) For  $m(t) = \cos 1000t \cos 3000t$

$$\begin{aligned} \varphi_{\text{DSB-SC}}(t) &= m(t) \cos 10,000t = \frac{1}{2} [\cos 2000t + \cos 4000t] \cos 10,000t \\ &= \frac{1}{2} [\cos 8000t + \cos 12,000t] + \frac{1}{2} [\cos 6000t + \cos 14,000t] \\ &= \frac{1}{2} \underbrace{[\cos 8000t + \cos 6000t]}_{\text{LSB}} + \frac{1}{2} \underbrace{[\cos 12,000t + \cos 14,000t]}_{\text{USB}} \end{aligned}$$

This information is summarized in a table below. Figure S4.7-1 shows various spectra.

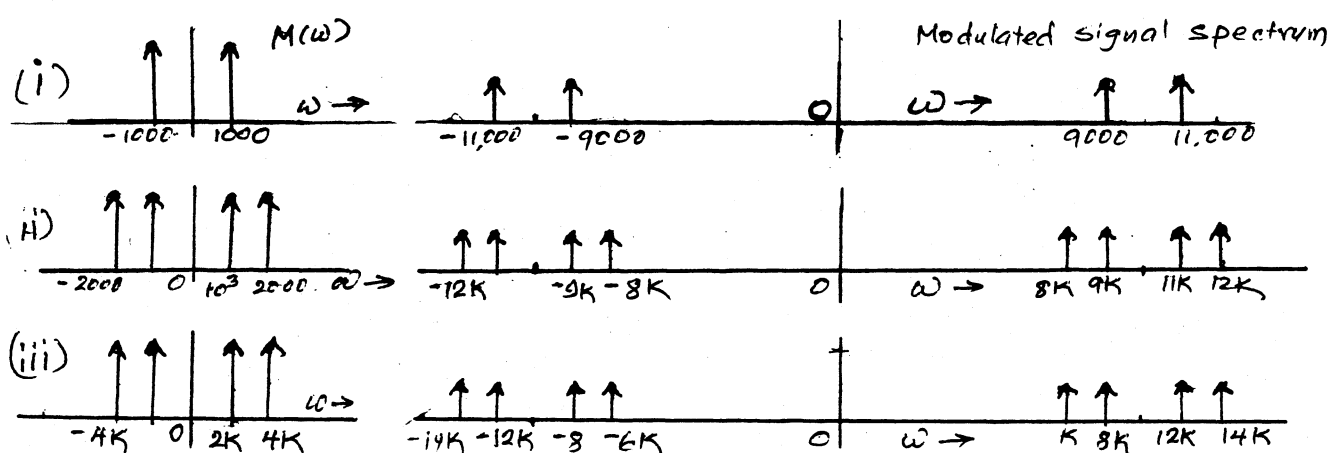

Fig. S4.7-1

case	Baseband frequency	DSB frequency	LSB frequency	USB frequency
i	1000	9000 and 11,000	9000	11,000
ii	1000	9000 and 11,000	9000	11,000
	2000	8000 and 12,000	8000	12,000
iii	2000	8000 and 12,000	8000	12,000
	4000	6000 and 14,000	6000	14,000

4.7-2 (a) The signal at point b is

$$\begin{aligned}
 f_a(t) &= m(t) \cos^3 \omega_c t \\
 &= m(t) \left[ \frac{3}{4} \cos \omega_c t + \frac{1}{4} \cos 3\omega_c t \right]
 \end{aligned}$$

The term  $\frac{3}{4}m(t) \cos \omega_c t$  is the desired modulated signal, whose spectrum is centered at  $\pm\omega_c$ . The remaining term  $\frac{1}{4}m(t) \cos 3\omega_c t$  is the unwanted term, which represents the modulated signal with carrier frequency  $3\omega_c$  with spectrum centered at  $\pm 3\omega_c$  as shown in Fig. S4.7-2. The bandpass filter centered at  $\pm\omega_c$  allows to pass the desired term  $\frac{3}{4}m(t) \cos \omega_c t$ , but suppresses the unwanted term  $\frac{1}{4}m(t) \cos 3\omega_c t$ . Hence, this system works as desired with the output  $\frac{3}{4}m(t) \cos \omega_c t$ .

(b) Figure S4.7-2 shows the spectra at points b and c.

(c) The minimum usable value of  $\omega_c$  is  $2\pi B$  in order to avoid spectral folding at dc.

(d)

$$\begin{aligned}
 m(t) \cos^2 \omega_c t &= \frac{m(t)}{2} [1 + \cos 2\omega_c t] \\
 &= \frac{1}{2}m(t) + \frac{1}{2}m(t) \cos 2\omega_c t
 \end{aligned}$$

The signal at point b consists of the baseband signal  $\frac{1}{2}m(t)$  and a modulated signal  $\frac{1}{2}m(t) \cos 2\omega_c t$ , which has a carrier frequency  $2\omega_c t$ , not the desired value  $\omega_c t$ . Both the components will be suppressed by the filter, whose center center frequency is  $\omega_c$ . Hence, this system will not do the desired job.

(e) The reader may verify that the identity for  $\cos n\omega_c t$  contains a term  $\cos \omega_c t$  when  $n$  is odd. This is not true when  $n$  is even. Hence, the system works for a carrier  $\cos^n \omega_c t$  only when  $n$  is odd.

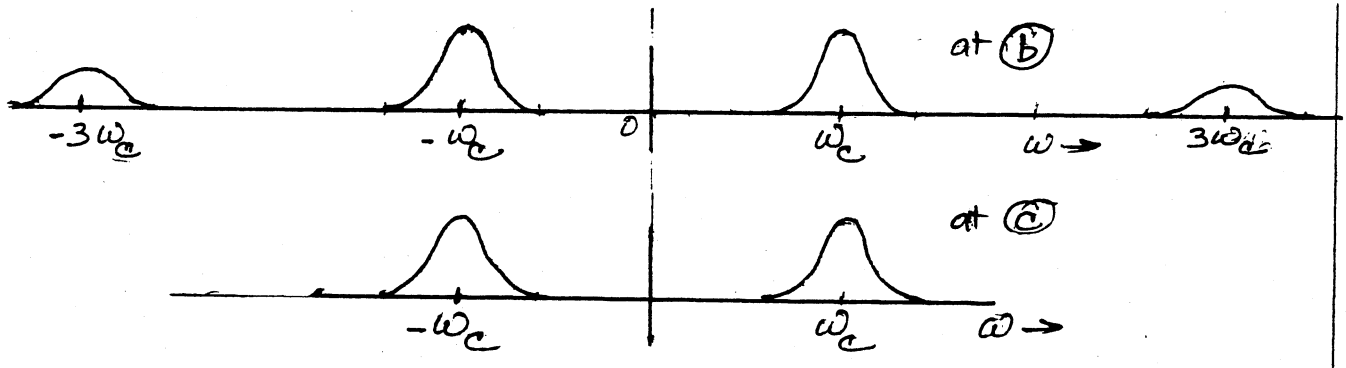

Fig. S4.7-2

4.7-3 This signal is identical to that in Fig. 3.8a with period  $T_0$  (instead of  $2\pi$ ). We find the Fourier series for this signal as

$$x(t) = \frac{1}{2} + \frac{2}{\pi} \left[ \cos \omega_c t - \frac{1}{3} \cos 3\omega_c t + \frac{1}{5} \cos 5\omega_c t + \dots \right]$$

Hence,  $y(t)$ , the output of the multiplier is

$$y(t) = m(t)x(t) = m(t) \left[ \frac{1}{2} + \frac{2}{\pi} \left( \cos \omega_c t - \frac{1}{3} \cos 3\omega_c t + \frac{1}{5} \cos 5\omega_c t + \dots \right) \right]$$

The bandpass filter suppresses the signals  $m(t)$  and  $m(t) \cos n\omega_c t$  for all  $n \neq 1$ . Hence, the bandpass filter output is

$$km(t) \cos \omega_c t = \frac{2}{\pi} m(t) \cos \omega_c t$$

4.7-4  $f_a(t) = [A + m(t)] \cos \omega_c t$ . Hence,

$$\begin{aligned} f_b(t) &= [A + m(t)] \cos^2 \omega_c t \\ &= \frac{1}{2}[A + m(t)] + \frac{1}{2}[A + m(t)] \cos 2\omega_c t \end{aligned}$$

The first term is a lowpass signal because its spectrum is centered at  $\omega = 0$ . The lowpass filter allows this term to pass, but suppresses the second term, whose spectrum is centered at  $\pm 2\omega_c$ . Hence the output of the lowpass filter is

$$y(t) = A + m(t)$$

When this signal is passed through a dc block, the dc term  $A$  is suppressed yielding the output  $m(t)$ . This shows that the system can demodulate AM signal regardless of the value of  $A$ . This is a synchronous or coherent demodulation.

4.7-5

$$\begin{aligned} \text{(a)} \quad \mu &= 0.5 = \frac{m_p}{A} = \frac{10}{A} \Rightarrow A = 20 \\ \text{(b)} \quad \mu &= 1.0 = \frac{m_p}{A} = \frac{10}{A} \Rightarrow A = 10 \\ \text{(c)} \quad \mu &= 2.0 = \frac{m_p}{A} = \frac{10}{A} \Rightarrow A = 5 \\ \text{(d)} \quad \mu &= \infty = \frac{m_p}{A} = \frac{10}{A} \Rightarrow A = 0 \end{aligned}$$

This means that  $\mu = \infty$  represents the DSB-SC case. Figure S4.7-5 shows various waveforms.

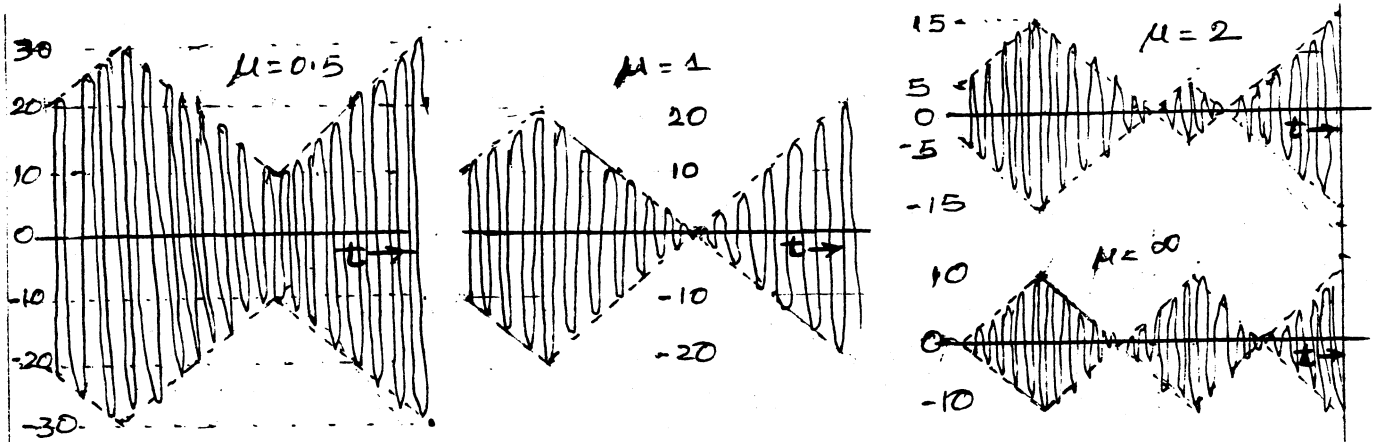

Fig. S4.7-5

4.7-6 To generate a DSB-SC signal from  $m(t)$ , we multiply  $m(t)$  with  $\cos \omega_c t$ . However, to generate the SSB signals of the same relative magnitude, it is convenient to multiply  $m(t)$  with  $2 \cos \omega_c t$ . This also avoids the nuisance of the fractions  $1/2$ , and yields the DSB-SC spectrum  $M(\omega - \omega_c) + M(\omega + \omega_c)$ . We suppress the USB spectrum (above  $\omega_c$  and below  $-\omega_c$ ) to obtain the LSB spectrum. Similarly, to obtain the USB spectrum, we suppress the LSB spectrum (between  $-\omega_c$  and  $\omega_c$ ) from the DSB-SC spectrum. Figures S4.7-6 a, b and c show the three cases.

(a) From Fig. a, we can express  $\varphi_{\text{LSB}}(t) = \cos 900t$  and  $\varphi_{\text{USB}}(t) = \cos 1100t$ .

(b) From Fig. b, we can express  $\varphi_{\text{LSB}}(t) = 2 \cos 700t + \cos 900t$  and  $\varphi_{\text{USB}}(t) = \cos 1100t + 2 \cos 1300t$ .

(c) From Fig. c, we can express  $\varphi_{\text{LSB}}(t) = \frac{1}{2}[\cos 400t + \cos 600t]$  and  $\varphi_{\text{USB}}(t) = \frac{1}{2}[\cos 1400t + 2 \cos 1600t]$ .

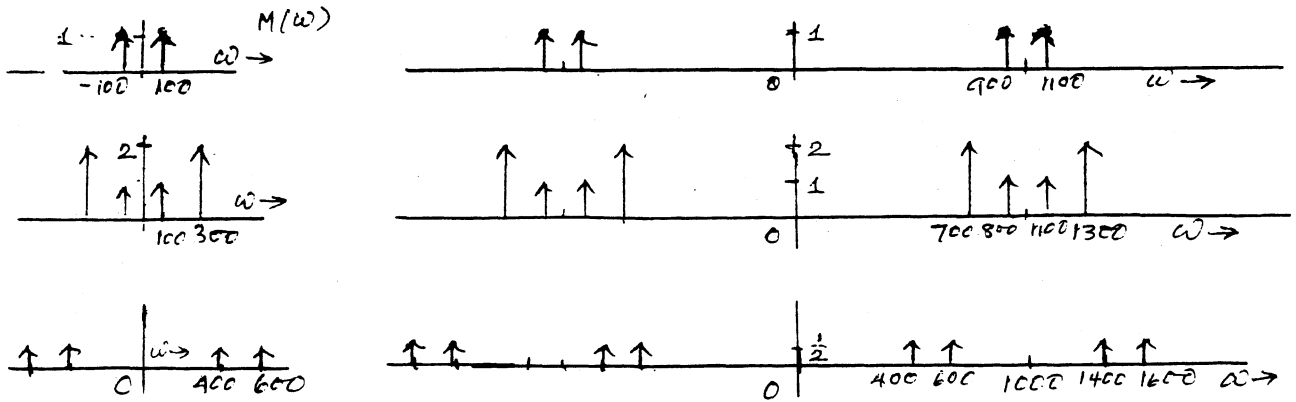

Fig. S4.7-6

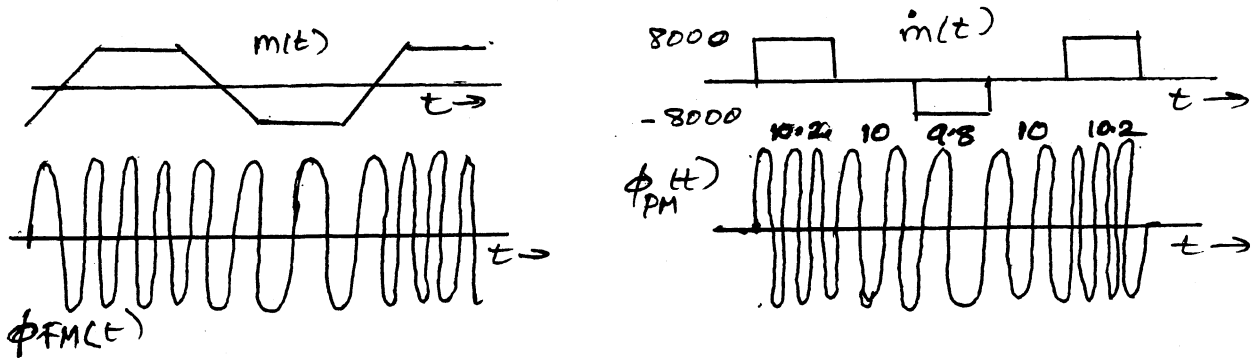

Fig. S4.8-1

4.8-1 In this case  $\mathcal{F}_c = 10$  MHz,  $m_p = 1$  and  $m'_p = 8000$ .

For FM

$\Delta\mathcal{F} = k_f m_p / 2\pi = 2\pi \times 10^5 / 2\pi = 10^5$  Hz. Also  $\mathcal{F}_c = 10^7$ . Hence,  $(\mathcal{F}_i)_{\max} = 10^7 + 10^5 = 10.1$  MHz. and  $(\mathcal{F}_i)_{\min} = 10^7 - 10^5 = 9.9$  MHz. The carrier frequency increases linearly from 9.9 MHz to 10.1 MHz over a quarter (rising) cycle of duration  $a$  seconds. For the next  $a$  seconds, when  $m(t) = 1$ , the carrier frequency remains at 10.1 MHz. Over the next quarter (the falling) cycle of duration  $a$ , the carrier frequency decreases linearly from 10.1 MHz to 9.9 MHz., and over the last quarter cycle, when  $m(t) = -1$ , the carrier frequency remains at 9.9 MHz. This cycles repeats periodically with the period  $4a$  seconds as shown in Fig. S4.8-1a.

For PM

$\Delta\mathcal{F} = k_p m'_p / 2\pi = 50\pi \times 8000 / 2\pi = 2 \times 10^5$  Hz. Also  $\mathcal{F}_c = 10^7$ . Hence,  $(\mathcal{F}_i)_{\max} = 10^7 + 2 \times 10^5 = 10.2$  MHz. and  $(\mathcal{F}_i)_{\min} = 10^7 - 2 \times 10^5 = 9.8$  MHz. Figure S4.8-1b shows  $\dot{m}(t)$ . We conclude that the frequency remains at 10.2 MHz over the (rising) quarter cycle, where  $\dot{m}(t) = 8000$ . For the next  $a$  seconds,  $\dot{m}(t) = 0$ , and the carrier frequency remains at 10 MHz. Over the next  $a$  seconds, where  $\dot{m}(t) = -8000$ , the carrier frequency remains at 9.8 MHz. Over the last quarter cycle  $\dot{m}(t) = 0$  again, and the carrier frequency remains at 10 MHz. This cycles repeats periodically with the period  $4a$  seconds as shown in Fig. S4.8-1.

4.8-2 In this case  $\mathcal{F}_c = 1$  MHz,  $m_p = 1$  and  $m'_p = 2000$ .

For FM

$\Delta\mathcal{F} = k_f m_p / 2\pi = 20,000\pi / 2\pi = 10^4$  Hz. Also  $\mathcal{F}_c = 1$  MHz. Hence,  $(\mathcal{F}_i)_{\max} = 10^6 + 10^4 = 1.01$  MHz. and  $(\mathcal{F}_i)_{\min} = 10^6 - 10^4 = 0.99$  MHz. The carrier frequency rises linearly from 0.99 MHz to 1.01 MHz over the cycle (over the interval  $-\frac{10^{-3}}{2} < t < \frac{10^{-3}}{2}$ ). Then instantaneously, the carrier frequency falls to 0.99 MHz and starts rising linearly to 1.01 MHz over the next cycle. The cycle repeats periodically with period  $10^{-3}$  as shown in Fig. S4.8-2a.

For PM

Here, because  $m(t)$  has jump discontinuities, we shall use a direct approach. For convenience, we select the origin for  $m(t)$  as shown in Fig. S4.8-2. Over the interval  $\frac{10^{-3}}{2}$  to  $\frac{10^{-3}}{2}$ , we can express the message signal as  $m(t) = 2000t$ . Hence,

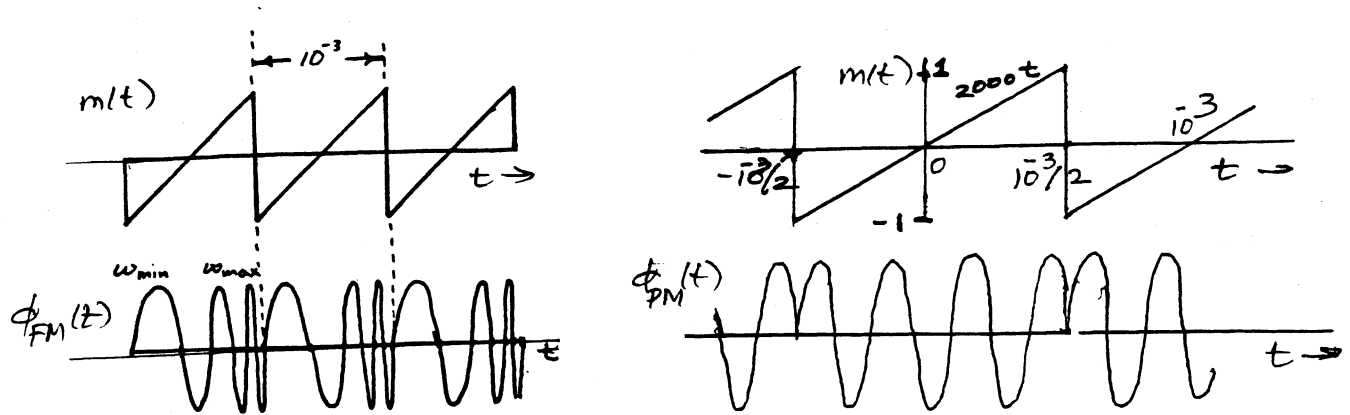

Fig. S4.8-2

$$\begin{aligned}
 \varphi_{PM}(t) &= \cos \left[ 2\pi(10)^6 t + \frac{\pi}{2} m(t) \right] \\
 &= \cos \left[ 2\pi(10)^6 t + \frac{\pi}{2} 2000t \right] \\
 &= \cos \left[ 2\pi(10)^6 t + 1000\pi t \right] = \cos \left[ 2\pi(10^6 + 500) t \right]
 \end{aligned}$$

At the discontinuity, the amount of jump is  $m_d = 2$ . Hence, the phase discontinuity is  $k_p m_d = \pi$ . Therefore, the carrier frequency is constant throughout at  $10^6 + 500$  Hz. But at the points of discontinuities, there is a phase discontinuity of  $\pi$  radians as shown in Fig. S4.8-2b. In this case, we must maintain  $k_p < \pi$  because there is a discontinuity of the amount 2. For  $k_p > \pi$ , the phase discontinuity will be higher than  $2\pi$  giving rise to ambiguity in demodulation.

4.8-3 In this case  $k_f = 1000\pi$  and  $k_p = 1$ . For

$$m(t) = 2 \cos 100t + 18 \cos 2000\pi t \quad \text{and} \quad \dot{m}(t) = -200 \sin 100t - 36,000\pi \sin 2000\pi t$$

Therefore  $m_p = 20$  and  $m'_p = 36,000\pi + 200$ . Also the baseband signal bandwidth  $B = 2000\pi/2\pi = 1$  kHz.

For FM:  $\Delta\mathcal{F} = k_f m_p/2\pi = 10,000$ , and  $B_{FM} = 2(\Delta\mathcal{F} + B) = 2(20,000 + 1000) = 42$  kHz.

For PM:  $\Delta\mathcal{F} = k_p m'_p/2\pi = 18,000 + \frac{100}{\pi}$  Hz, and  $B_{PM} = 2(\Delta\mathcal{F} + B) = 2(18,031.83 + 1000) = 38.06366$  kHz.

4.8-4  $\varphi_{EM}(t) = 10 \cos(\omega_c t + 0.1 \sin 2000\pi t)$ . Here, the baseband signal bandwidth  $B = 2000\pi/2\pi = 1000$  Hz. Also,

$$\omega_i(t) = \omega_c + 200\pi \cos 2000\pi t$$

Therefore,  $\Delta\omega = 200\pi$  and  $\Delta\mathcal{F} = 100$  Hz and  $B_{EM} = 2(\Delta\mathcal{F} + B) = 2(100 + 1000) = 2.2$  kHz.

4.8-5  $\varphi_{EM}(t) = 5 \cos(\omega_c t + 20 \sin 1000\pi t + 10 \sin 2000\pi t)$ .

Here, the baseband signal bandwidth  $B = 2000\pi/2\pi = 1000$  Hz. Also,

$$\omega_i(t) = \omega_c + 20,000\pi \cos 1000\pi t + 20,000\pi \cos 2000\pi t$$

Therefore,  $\Delta\omega = 20,000\pi + 20,000\pi = 40,000\pi$  and  $\Delta\mathcal{F} = 20$  kHz and  $B_{EM} = 2(\Delta\mathcal{F} + B) = 2(20,000 + 1000) = 42$  kHz.

# Chapter 5

---

**5.1-1** The bandwidths of  $f_1(t)$  and  $f_2(t)$  are 100 kHz and 150 kHz, respectively. Therefore the Nyquist sampling rates for  $f_1(t)$  is 200 kHz and for  $f_2(t)$  is 300 kHz.

Also  $f_1^2(t) \iff \frac{1}{2\pi} F_1(\omega) * F_1(\omega)$ , and from the width property of convolution the bandwidth of  $f_1^2(t)$  is twice the bandwidth of  $f_1(t)$  and that of  $f_2^3(t)$  is three times the bandwidth of  $f_2(t)$  (see also Prob. 4.3-10). Similarly the bandwidth of  $f_1(t)f_2(t)$  is the sum of the bandwidth of  $f_1(t)$  and  $f_2(t)$ . Therefore the Nyquist rate for  $f_1^2(t)$  is 400 kHz, for  $f_2^3(t)$  is 900 kHz, for  $f_1(t)f_2(t)$  is 500 kHz.

**5.1-2 (a)**

$$\text{sinc}^2(100\pi t) \iff 0.01 \Delta\left(\frac{\omega}{400\pi}\right)$$

The bandwidth of this signal is  $200 \pi$  rad/s or 100 Hz. The Nyquist rate is 200 Hz (samples/sec)

**(b)** The Nyquist rate is 200 Hz, the same as in **(a)**, because multiplication of a signal by a constant does not change its bandwidth.

**(c)**

$$\text{sinc}(100\pi t) + 3 \text{sinc}^2(60\pi t) \iff 0.01 \text{rect}\left(\frac{\omega}{200\pi}\right) + \frac{1}{20} \Delta\left(\frac{\omega}{240\pi}\right)$$

The bandwidth of  $\text{rect}\left(\frac{\omega}{200\pi}\right)$  is 50 Hz and that of  $\Delta\left(\frac{\omega}{240\pi}\right)$  is 60 Hz. The bandwidth of the sum is the higher of the two, that is, 60 Hz. The Nyquist sampling rate is 120 Hz.

**(d)**

$$\begin{aligned} \text{sinc}(50\pi t) &\iff 0.02 \text{rect}\left(\frac{\omega}{100\pi}\right) \\ \text{sinc}(100\pi t) &\iff 0.01 \text{rect}\left(\frac{\omega}{200\pi}\right) \end{aligned}$$

The two signals have bandwidths 25 Hz and 50 Hz respectively. The spectrum of the product of two signals is  $1/2\pi$  times the convolution of their spectra. From width property of the convolution, the width of the convoluted signal is the sum of the widths of the signals convolved. Therefore, the bandwidth of  $\text{sinc}(50\pi t)\text{sinc}(100\pi t)$  is  $25 + 50 = 75$  Hz. The Nyquist rate is 150 Hz.

**5.1-3**

The spectrum of  $f(t) = \text{sinc}(200\pi t)$  is  $F(\omega) = 0.005 \text{rect}\left(\frac{\omega}{400\pi}\right)$ . The bandwidth of this signal is 100 Hz (200π rad/s). Consequently, the Nyquist rate is 200 Hz, that is, we must sample the signal at a rate no less than 200 samples/second.

Recall that the sampled signal spectrum consists of  $(1/T)F(\omega) = \frac{0.005}{T} \text{rect}\left(\frac{\omega}{400\pi}\right)$  repeating periodically with period equal to the sampling frequency  $\mathcal{F}_s$  Hz. We present this information in the following Table for three sampling rates:  $\mathcal{F}_s = 150$  Hz (undersampling), 200 Hz (Nyquist rate), and 300 Hz (oversampling).

sampling frequency $\mathcal{F}_s$	sampling interval $T$	$\frac{1}{T}F(\omega)$	comments
150 Hz	0.006667	$0.75 \text{rect}\left(\frac{\omega}{400\pi}\right)$	Undersampling
200 Hz	0.005	$\text{rect}\left(\frac{\omega}{400\pi}\right)$	Nyquist Rate
300 Hz	0.003334	$1.5 \text{rect}\left(\frac{\omega}{400\pi}\right)$	Oversampling

The spectra of  $\bar{F}(\omega)$  for the three cases are shown in Fig. S5.1-3. In the first case, we cannot recover  $f(t)$  from the sampled signal because of overlapping cycles, which makes it impossible to identify  $F(\omega)$  from the corresponding  $\bar{F}(\omega)$ . In the second and the third case, the repeating spectra do not overlap, and it is possible to recover  $F(\omega)$  from  $\bar{F}(\omega)$  using a lowpass filter of bandwidth 100 Hz. In the last case the spectrum  $\bar{F}(\omega) = 0$  over the band between 100 and 200 Hz. Hence to recover  $F(\omega)$ , we may use a practical lowpass filter with gradual

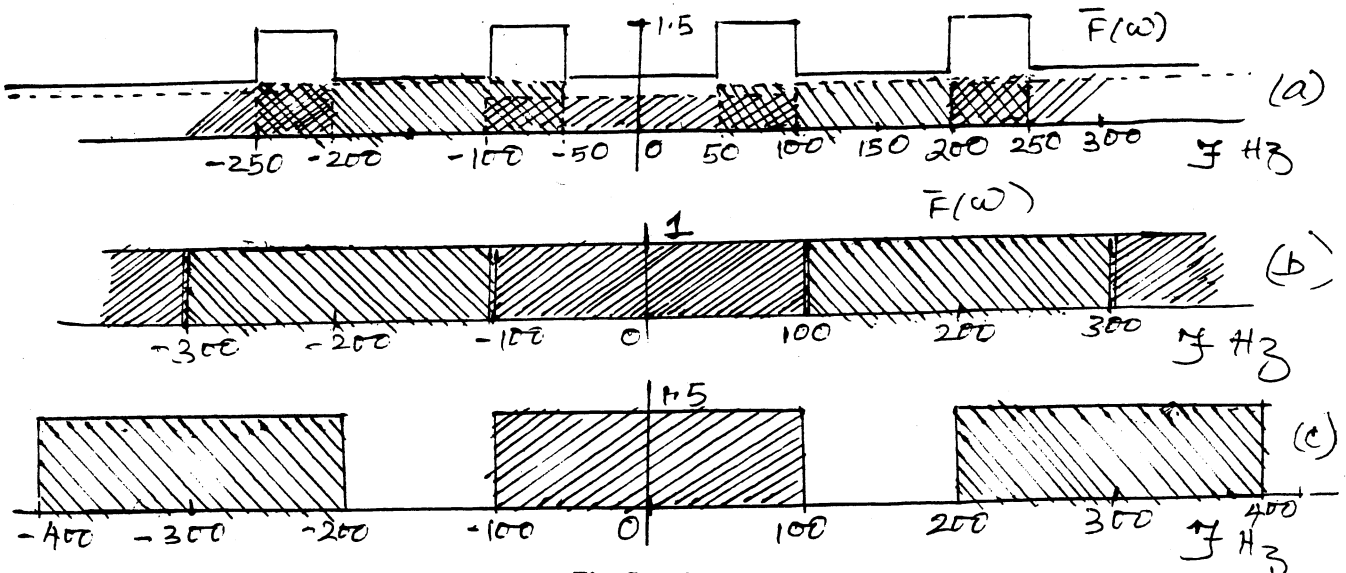

Fig. S5.1-3

cutoff between 100 and 200 Hz. The output in the second case is  $f(t)$ , and in the third case is  $1.5f(t)$ . The output spectra in the three cases are shown in Fig. S5.1-3.

- 5.1-4 (a) When the input to this filter is  $\delta(t)$ , the output of the summer is  $\delta(t) - \delta(t - T)$ . This acts as the input to the integrator. And,  $h(t)$ , the output of the integrator is:

$$h(t) = \int_0^t [\delta(\tau) - \delta(\tau - T)] d\tau = u(t) - u(t - T) = \text{rect} \left( \frac{t - T/2}{T} \right)$$

The impulse response  $h(t)$  is shown in Fig. S5.1-4a.

(b) The transfer function of this circuit is:

$$H(\omega) = T \text{sinc} \left( \frac{\omega T}{2} \right) e^{-j\omega T/2}$$

and

$$|H(\omega)| = T \left| \text{sinc} \left( \frac{\omega T}{2} \right) \right|$$

The amplitude response of the filter is shown in Fig. S5.1-4b. Observe that the filter is a lowpass filter of bandwidth  $2\pi/T$  rad/s or  $1/T$  Hz.

The impulse response of the circuit is a rectangular pulse. When a sampled signal is applied at the input, each sample generates a rectangular pulse at the output, proportional to the corresponding sample value. Hence the output is a staircase approximation of the input as shown in Fig. S5.1-4c.

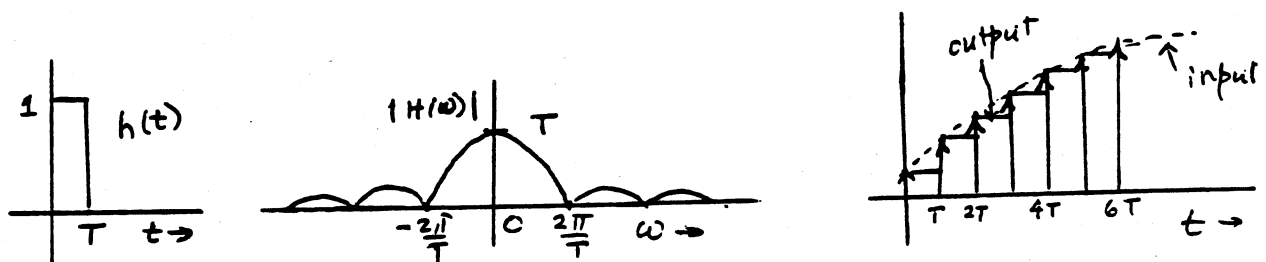

Figure S5.1-4

- 5.1-5 (a) Figure S5.1-5a shows the signal reconstruction from its samples using the first-order hold circuit. Each sample generates a triangle of width  $2T$  and centered at the sampling instant. The height of the triangle is equal to the sample value. The resulting signal consists of straight line segments joining the sample tops.  
 (b) The transfer function of this circuit is:

$$H(\omega) = \mathcal{F}\{h(t)\} = \mathcal{F} \left\{ \Delta \left( \frac{t}{2T} \right) \right\} = T \text{sinc}^2 \left( \frac{\omega T}{2} \right)$$

Because  $H(\omega)$  is positive for all  $\omega$ , it also represents the amplitude response. Fig. S5.1-5b shows the impulse response  $h(t) = \Delta(\frac{t}{2T})$ . The corresponding amplitude response  $H(\omega)$  and the ideal amplitude response (lowpass) required for signal reconstruction is shown in Fig. S5.1-5c.

(c) A minimum of  $T$  secs delay is required to make  $h(t)$  causal (realizable). Such a delay would cause the reconstructed signal in Fig. S5.1-5a to be delayed by  $T$  secs.

(d) When the input to the first filter is  $\delta(t)$ , then as shown in Prob. 5.1-4, its output is a rectangular pulse  $p(t) = u(t) - u(t - T)$  shown in Fig. S5.1-4a. This pulse  $p(t)$  is applied to the input of the second identical filter.

The output of the summer of the second filter is  $p(t) - p(t - T) = u(t) - 2u(t - T) + u(t - 2T)$ , which is applied to the integrator. The output  $h(t)$  of the integrator is the area under  $p(t) - p(t - T)$ , which, as

$$h(t) = \int_0^t [u(\tau) - 2u(\tau - T) + u(\tau - 2T)] d\tau = tu(t) - 2(t - T)u(t - T) + (t - 2T)u(t - 2T) = \Delta \left( \frac{t - T}{T} \right)$$

shown in Fig. S5.1-5b.

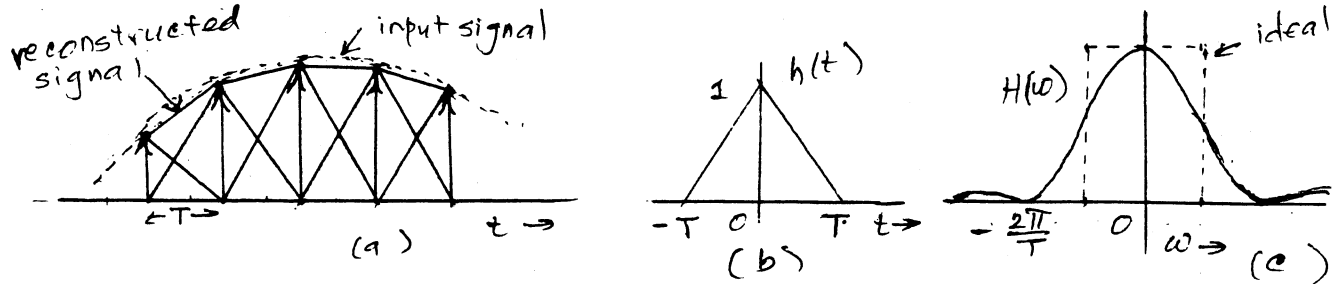

Figure S5.1-5

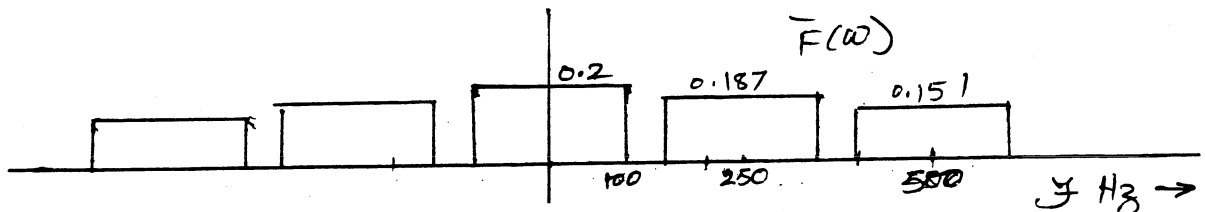

Figure S5.1-6

- 5.1-6 The signal  $f(t) = \text{sinc}(200\pi t)$  is sampled by a rectangular pulse sequence  $p_T(t)$  whose period is 4 ms so that the fundamental frequency (which is also the sampling frequency) is 250 Hz. Hence,  $\omega_s = 500\pi$ . The Fourier series for  $p_T(t)$  is given by

$$p_T(t) = C_0 + \sum_{n=1}^{\infty} C_n \cos n\omega_s t$$

Use of Eqs. (3.66) yields  $C_0 = \frac{1}{5}$ ,  $C_n = \frac{2}{n\pi} \sin \left( \frac{n\pi}{5} \right)$ , that is,

$$C_0 = 0.2, \quad C_1 = 0.374, \quad C_2 = 0.303, \quad C_3 = 0.202, \quad C_4 = 0.093, \quad C_5 = 0, \dots$$

Consequently

$$\bar{f}(t) = f(t)p_T(t) = 0.2 f(t) + 0.374 f(t) \cos 500\pi t + 0.303 f(t) \cos 1000\pi t + 0.202 f(t) \cos 1500\pi t + \dots$$

and

$$\begin{aligned} \bar{F}(\omega) = & 0.2 F(\omega) + 0.187 [F(\omega - 500\pi) + F(\omega + 500\pi)] \\ & + 0.151 [F(\omega - 1000\pi) + F(\omega + 1000\pi)] \\ & + 0.101 [F(\omega - 1500\pi) + F(\omega + 1500\pi)] + \dots \end{aligned}$$

In the present case  $F(\omega) = 0.005 \text{rect}(\frac{\omega}{400\pi})$ . The spectrum  $\bar{F}(\omega)$  is shown in Fig. S5.1-6. Observe that the spectrum consists of  $F(\omega)$  repeating periodically at the interval of  $500\pi$  rad/s (250 Hz). Hence, there is no overlap between cycles, and  $F(\omega)$  can be recovered by using an ideal lowpass filter of bandwidth 100 Hz. An ideal lowpass filter of unit gain (and bandwidth 100 Hz) will allow the first term on the right-side of the above equation to pass fully and suppress all the other terms. Hence the output  $y(t)$  is

$$y(t) = 0.2 f(t)$$



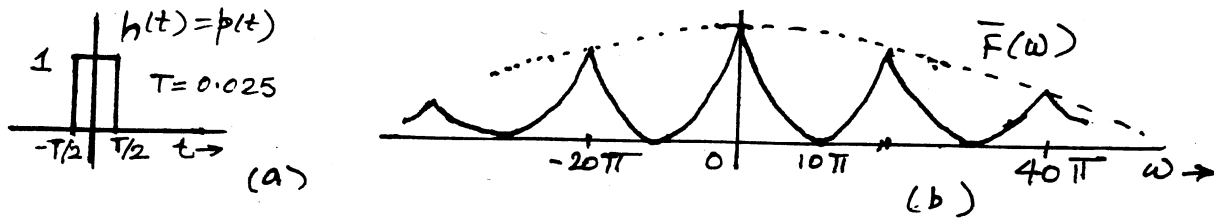

Figure S5.1-7

Because the spectrum  $\bar{F}(\omega)$  has a zero value in the band from 100 to 150 Hz, we can use an ideal lowpass filter of bandwidth  $B$  Hz where  $100 < B < 150$ . But if  $B > 150$  Hz, the filter will pick up the unwanted spectral components from the next cycle, and the output will be distorted.

- 5.1-7 The signal  $f(t)$ , when sampled by an impulse train, results in the sampled signal  $f(t)\delta_T(t)$  (as shown in Fig. 5.1d). If this signal is transmitted through a filter (Fig. S5.1-7a) whose impulse response is  $h(t) = p(t) = \text{rect}(\frac{t}{0.025})$ , then each impulse in the input will generate a pulse  $p(t)$ , resulting in the desired sampled signal shown in Fig. P5.1-7. Moreover, the spectrum of the impulse train  $f(t)\delta_T(t)$  is  $\frac{1}{T} \sum_{n=-\infty}^{\infty} F(\omega - n\omega_s)$ . Hence, the output of the filter in Fig. S5.1-7a is

$$\bar{F}(\omega) = H(\omega) \left[ \frac{1}{T} \sum_{n=-\infty}^{\infty} F(\omega - n\omega_s) \right]$$

where  $H(\omega) = P(\omega) = 0.025 \text{sinc}(\frac{\omega}{80})$ , the Fourier transform of  $\text{rect}(\frac{t}{0.025})$ . Figure S5.1-7b shows this spectrum consisting of the repeating spectrum  $F(\omega)$  multiplied by  $H(\omega) = 0.025 \text{sinc}(\frac{\omega}{80})$ . Thus, each cycle is somewhat distorted.

To recover the signal  $f(t)$  from the flat top samples, we reverse the process in Fig. S5.1-7a. First, we pass the sampled signal through a filter with transfer function  $1/H(\omega)$ . This will yield the signal sampled by impulse train. Now we pass this signal through an ideal lowpass filter of bandwidth  $B$  Hz to obtain  $f(t)$ .

5.1-8

- (a) The bandwidth is 15 kHz. The Nyquist rate is 30 kHz.
- (b)  $65536 = 2^{16}$ , so that 16 binary digits are needed to encode each sample.
- (c)  $30000 \times 16 = 480000$  bits/s.
- (d)  $44100 \times 16 = 705600$  bits/s.

5.1-9

- (a) The Nyquist rate is  $2 \times 4.5 \times 10^6 = 9$  MHz. The actual sampling rate =  $1.2 \times 9 = 10.8$  MHz.
- (b)  $1024 = 2^{10}$ , so that 10 bits or binary pulses are needed to encode each sample.
- (c)  $10.8 \times 10^6 \times 10 = 108 \times 10^6$  or 108 Mbits/s.

- 5.1-10 Assume a signal  $f(t)$  that is simultaneously timelimited and bandlimited. Let  $F(\omega) = 0$  for  $|\omega| > 2\pi B$ . Therefore  $F(\omega)\text{rect}(\frac{\omega}{4\pi B'}) = F(\omega)$  for  $B' > B$ . Therefore from the time-convolution property (4.42)

$$\begin{aligned} f(t) &= f(t) * [2B' \text{sinc}(2\pi B' t)] \\ &= 2B' f(t) * \text{sinc}(2\pi B' t) \end{aligned}$$

Because  $f(t)$  is timelimited,  $f(t) = 0$  for  $|t| > T$ . But  $f(t)$  is equal to convolution of  $f(t)$  with  $\text{sinc}(2\pi B' t)$  which is not timelimited. It is impossible to obtain a time-limited signal from the convolution of a time-limited signal with a non-timelimited signal.

5.2-1

$$T_0 = \frac{1}{\mathcal{F}_o} = \frac{1}{50} = 20\text{ms}$$

$$B = 10000 \quad \text{Hence} \quad \mathcal{F}_s \geq 2B = 20000$$

$$T = \frac{1}{\mathcal{F}_s} = \frac{1}{20000} = 50\mu\text{s}$$

$$N_0 = \frac{T_0}{T} = \frac{20 \times 10^{-3}}{50 \times 10^{-6}} = 400$$

Since  $N_0$  must be a power of 2, we choose  $N_0 = 512$ . Also  $T = 50\mu s$ , and  $T_0 = N_0 T = 512 \times 50\mu s = 25.6ms$ .  $\mathcal{F}_0 = 1/T_0 = 39.0625$  Hz. Since  $f(t)$  is of 10 ms duration, we need zero padding over 15.6 ms. Alternatively, we could also have used

$$T = \frac{20 \times 10^{-3}}{512} = 39.0625 \mu s$$

This gives  $T_0 = 20$  ms,  $\mathcal{F}_0 = 50$  Hz. And

$$\mathcal{F}_s = \frac{1}{T} = 25600\text{Hz}$$

There are also other possibilities of reducing  $T$  as well as increasing the frequency resolution.

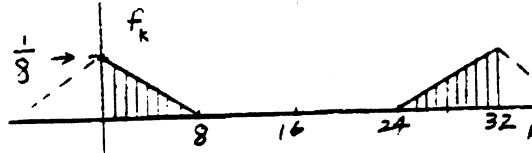

Figure S5.2-2

5.2-2 For the signal  $f(t)$ ,

$$T_0 \geq \frac{1}{0.25} = 4, \quad T \leq \frac{1}{\mathcal{F}_s} = \frac{1}{3 \times 2} = \frac{1}{6}$$

Let us choose  $T = 1/8$ . Also  $T_0 = 4$ . Therefore,  $N_0 = T_0/T = 32$ . The signal  $f(t)$  repeats every 4 seconds with samples every  $1/8$  second. The samples are  $Tf(kT) = (1/8)f(k/8)$ . Thus, the first sample is (at  $k = 0$ )  $1 \times (1/8) = 1/8$ . The 32 samples are (starting at  $k = 0$ )

$$\frac{1}{8}, \frac{7}{64}, \frac{3}{32}, \frac{5}{64}, \frac{1}{16}, \frac{3}{64}, \frac{1}{32}, \frac{1}{64}, 0, 0, 0, 0, 0, 0, 0, 0, \\ 0, 0, 0, 0, 0, 0, 0, 0, \frac{1}{64}, \frac{1}{32}, \frac{3}{64}, \frac{1}{16}, \frac{5}{64}, \frac{3}{32}, \frac{7}{64}$$

The samples of  $f(t)$  and  $g(t)$  are shown in Fig. S5.2-2.

5.2-3

$$f(t) = e^{-t}u(t) \quad F(\omega) = \frac{1}{j\omega + 1}$$

(a) We take the folding frequency  $\mathcal{F}_s$  to be the frequency where  $|F(\omega)|$  is 1% of its peak value, which happens to be 1 (at  $\omega = 0$ ). Hence,

$$|F(\omega)| \approx \frac{1}{\omega} = 0.01 \Rightarrow \omega = 2\pi B = 100$$

This yields  $B = 50/\pi$ , and  $T \leq 1/2B = \pi/100$ . Let us round  $T$  to 0.03125, resulting in 32 samples per second. The time constant of  $e^{-t}$  is 1. For  $T_0$ , a reasonable choice is 5 to 6 time constants or more. Value of  $T_0 = 5$  or 6 results in  $N_0 = 160$  or 192, neither of which is a power of 2. Hence, we choose  $T_0 = 8$ , resulting in  $N_0 = 32 \times 8 = 256$ , which is a power of 2.

(b)

$$|F(\omega)| = \frac{1}{\sqrt{\omega^2 + 1}} \approx \frac{1}{\omega} \quad \omega \gg 1$$

We take the folding frequency  $\mathcal{F}_s$  to be the 99% energy frequency as explained in Example 4.16. From the results in Example 4.16, (with  $a = 1$ ) we have

$$\frac{0.99\pi}{2} = \tan^{-1} \frac{W}{a} \Rightarrow W = 63.66a = 63.66 \text{ rad/sec.}$$

This yields  $B = \frac{W}{2\pi} = 10.13$  Hz. Also  $T \leq 1/2B = 0.04936$ . This results in the sampling rate  $\frac{1}{T} = 20.26$  Hz. Also  $T_0 = 8$  as explained in part (a). This yields  $N_0 = 20.26 \times 8 = 162.08$ , which is not a power of 2. Hence, we choose the next higher value, that is  $N_0 = 256$ , which yields  $T = 0.03125$  and  $T_0 = 8$ , the same as in part (a).

5.2-4

$$f(t) = \frac{2}{t^2 + 1}$$

Application of duality property to pair 3 (Table 4.1) yields

$$\frac{2}{t^2 + 1} \iff 2\pi e^{-|\omega|}$$

Following the approach of Prob. 5.2-2, we find that the peak value of  $|F(\omega)| = 2\pi e^{-|\omega|}$  is  $2\pi$  (occurring at  $\omega = 0$ ). Also,  $2\pi e^{-|\omega|}$  becomes  $0.01 \times 2\pi$  (1% of the peak value) at  $\omega = \ln 100 = 4.605$ . Hence,  $B = 4.605/2\pi = 0.733$  Hz, and  $T \leq 1/2B = 0.682$ . Also,

$$f(0) = 2 \quad \text{and} \quad f(t) \simeq \frac{2}{t^2} \quad t \gg 1$$

Choose  $T_0$  (the duration of  $f(t)$ ) to be the instant where  $f(t)$  is 1% of  $f(0)$ .

$$f(T_0) = \frac{2}{T_0^2 + 1} = \frac{2}{100} \implies T_0 \approx 10$$

This results in  $N_0 = T_0/T = 10/0.682 = 14.66$ . We choose  $N_0 = 16$ , which is a power of 2. This yields  $T = 0.625$  and  $T_0 = 10$ .

(b) The energy of this signal is

$$E_f = \frac{2}{2\pi} \int_0^\infty (2\pi)^2 e^{-2\omega} d\omega = 2\pi$$

The energy within the band from  $\omega = 0$  to  $W$  is given by

$$E_W = \frac{8\pi^2}{2\pi} \int_0^W e^{-2\omega} d\omega = 2\pi(1 - e^{-2W})$$

But  $E_W = 0.99E_f = 0.99 \times 2\pi$ . Hence,

$$0.99(2\pi) = 2\pi(1 - e^{-2W}) \implies W = 2.303$$

Hence,  $B = W/2\pi = 0.366$  Hz. Thus,  $T \leq 1/2B = 1.366$ . Also,  $T_0 = 10$  as found in part (a). Hence,  $N_0 = T_0/T = 7.32$ . We select  $N_0 = 8$  (a power of 2), resulting in  $N_0 = 8$  and  $T = 1.25$ .

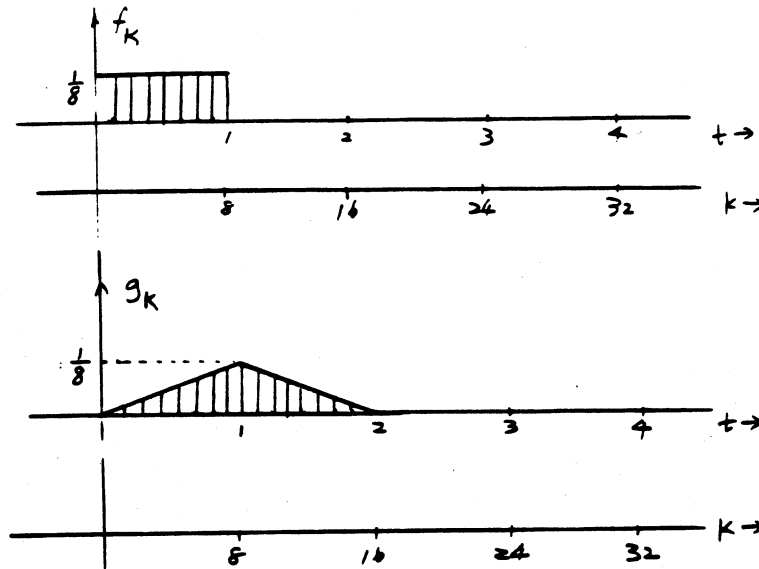

Figure S5.2-5

5.2-5 The widths of  $f(t)$  and  $g(t)$  are 1 and 2 respectively. Hence the width of the convolved signal is  $1 + 2 = 3$ . This means we need to zero-pad  $f(t)$  for 2 secs. and  $g(t)$  for 1 sec., making  $T_0 = 3$  for both signals. Since  $T = 0.125$

$$N_0 = \frac{3}{0.125} = 24$$

$N_0$  must be a power of 2. Choose  $N_0 = 32$ . This permits us to adjust  $T_0$  to 4. Hence the final values are  $T = 0.125$  and  $T_0 = 4$ . The samples of  $f(t)$  and  $g(t)$  are shown in Fig. S5.2-5.

# Chapter 6

---

6.1-1 (a)

$$f(t) = u(t) - u(t-1)$$

$$\begin{aligned} F(s) &= \int_0^1 e^{-st} dt = -\frac{e^{-st}}{s} \Big|_0^1 \\ &= -\frac{1}{s}[e^{-s} - 1] \\ &= \frac{1}{s}[1 - e^{-s}] \end{aligned}$$

Note that the result is valid for all values of  $s$ ; hence the region of convergence is the entire  $s$ -plane. The abscissa of convergence is  $\sigma_0 = -\infty$ .

(b)

$$f(t) = te^{-t}u(t)$$

$$\begin{aligned} F(s) &= \int_0^{\infty} te^{-t}e^{-st} dt = \int_0^{\infty} te^{-(s+1)t} dt \\ &= -\frac{e^{-(s+1)t}}{(s+1)^2} [-(s+1)t - 1] \Big|_0^{\infty} \\ &= \frac{1}{(s+1)^2} \end{aligned}$$

provided that  $e^{-(s+1)\infty} = 0$  or  $\text{Re}(s+1) > 0$ . Hence the abscissa of convergence is  $\text{Re}(s) > -1$  or  $\sigma_0 > -1$ .

(c)

$$f(t) = t \cos \omega_0 t u(t)$$

$$\begin{aligned} F(s) &= \int_0^{\infty} t \cos \omega_0 t e^{-st} dt \\ &= \frac{1}{2} \left\{ \int_0^{\infty} [te^{(j\omega_0 - s)t} + te^{-(j\omega_0 + s)t}] dt \right\} \\ &= \frac{1}{2} \left[ \frac{1}{(s - j\omega_0)^2} + \frac{1}{(s + j\omega_0)^2} \right] \quad \text{Re}(s) > 0 \\ &= \frac{s^2 - \omega_0^2}{(s^2 + \omega_0^2)^2} \end{aligned}$$

(d)

$$f(t) = (e^{2t} - 2e^{-t})u(t)$$

$$\begin{aligned} F(s) &= \int_0^{\infty} (e^{2t} - 2e^{-t})e^{-st} dt \\ &= \int_0^{\infty} e^{2t}e^{-st} dt - 2 \int_0^{\infty} e^{-t}e^{-st} dt \\ &= \int_0^{\infty} e^{-(s-2)t} dt - 2 \int_0^{\infty} e^{-(s+1)t} dt \\ &= \frac{1}{s-2} - \frac{2}{s+1} \end{aligned}$$

We get the first term only if  $\text{Re } s > 2$ , and we get the second term only if  $\text{Re } (s) > -1$ . Both conditions will be satisfied if  $\text{Re } (s) > 2$  or  $\sigma_0 > 2$ . Hence:

$$F(s) = \frac{1}{s-2} - \frac{2}{s+1} \quad \text{for } \sigma_0 > 2$$

(e)

$$f(t) = \cos \omega_1 t \cos \omega_2 t u(t) = \left[ \frac{1}{2} \cos(\omega_1 + \omega_2)t + \frac{1}{2} \cos(\omega_1 - \omega_2)t \right] u(t)$$

$$\begin{aligned} F(s) &= \frac{1}{2} \int_0^{\infty} \cos(\omega_1 + \omega_2)t e^{-st} dt + \frac{1}{2} \int_0^{\infty} \cos(\omega_1 - \omega_2)t e^{-st} dt \\ &= \frac{1}{2} \left[ \frac{s}{s^2 + (\omega_1 + \omega_2)^2} + \frac{s}{s^2 + (\omega_1 - \omega_2)^2} \right] \end{aligned}$$

provided that  $\text{Re } (s) > 0$ .

(f)

$$f(t) = \cosh(at)u(t)$$

$$\begin{aligned} F(s) &= \frac{1}{2} \left[ \int_0^{\infty} e^{at} e^{-st} dt + \int_0^{\infty} e^{-at} e^{-st} dt \right] \\ &= \frac{1}{2} \left[ \int_0^{\infty} e^{-(s-a)t} dt + \int_0^{\infty} e^{-(s+a)t} dt \right] \\ &= \frac{s}{s^2 - a^2} \quad \text{Re } s > |a| \end{aligned}$$

(g)

$$f(t) = \sinh(at)u(t)$$

$$\begin{aligned} F(s) &= \frac{1}{2} \left[ \int_0^{\infty} e^{-(s-a)t} dt - \int_0^{\infty} e^{-(s+a)t} dt \right] \\ &= \frac{a}{s^2 - a^2} \quad \text{Re } s > |a| \end{aligned}$$

(h)

$$\begin{aligned} f(t) &= e^{-2t} \cos(5t + \theta)u(t) \\ &= \frac{1}{2} [e^{-2t+j(5t+\theta)} + e^{-2t-j(5t+\theta)}] \\ &= \frac{1}{2} e^{j\theta} e^{-(2-j5)t} + \frac{1}{2} e^{-j\theta} e^{-(2+j5)t} \end{aligned}$$

$$\text{Hence } F(s) = \frac{1}{2} e^{j\theta} \left( \frac{1}{s+2-j5} \right) + \frac{1}{2} e^{-j\theta} \left( \frac{1}{s+2+j5} \right)$$

This is valid if  $\text{Re } (s) > -2$  for both terms; hence

$$F(s) = \frac{(s+2) \cos \theta - 5 \sin \theta}{s^2 + 4s + 29}$$

6.1-2 (a)

$$F(s) = \int_0^1 t e^{-st} dt = \frac{e^{-st}}{s} (-st - 1) \Big|_0^1 = \frac{1}{s^2} (1 - e^{-s} - s e^{-s})$$

(b)

$$F(s) = \int_0^{\pi} \sin t e^{-st} dt = \frac{e^{-st}}{s^2 + 1} (-s \sin t - \cos t) \Big|_0^{\pi} = \frac{1 + e^{-\pi s}}{s^2 + 1}$$

(c)

$$\begin{aligned} F(s) &= \int_0^1 \frac{t}{e} e^{-st} dt + \int_1^\infty e^{-t} e^{-st} dt = \frac{1}{e} \int_0^1 t e^{-st} dt + \int_1^\infty e^{-(s+1)t} dt \\ &= \frac{e^{-st}}{es} (-st - 1) \Big|_0^1 - \frac{1}{s+1} e^{-(s+1)t} \Big|_1^\infty \\ &= \frac{1}{es^2} (1 - e^{-s} - s e^{-s}) + \frac{1}{s+1} e^{-(s+1)} \end{aligned}$$

6.1-3 (a)

$$\begin{aligned} F(s) &= \frac{2s+5}{s^2+5s+6} = \frac{2s+5}{(s+2)(s+3)} = \frac{1}{s+2} + \frac{1}{s+3} \\ f(t) &= (e^{-2t} + e^{-3t})u(t) \end{aligned}$$

(b)

$$F(s) = \frac{3s+5}{s^2+4s+13}$$

Here  $A = 3$ ,  $B = 5$ ,  $a = 2$ ,  $c = 13$ ,  $b = \sqrt{13-4} = 3$ .

$$r = \sqrt{\frac{117+25-60}{13-4}} = 3.018 \quad \theta = \tan^{-1}\left(\frac{1}{3}\right) = 6.34^\circ$$

$$f(t) = 3.018 e^{-2t} \cos(3t + 6.34^\circ) u(t)$$

(c)

$$F(s) = \frac{(s+1)^2}{s^2-s-6} = \frac{(s+1)^2}{(s+2)(s-3)}$$

This is an improper fraction with  $b_n = b_2 = 1$ . Therefore

$$\begin{aligned} F(s) &= 1 + \frac{a}{s+2} + \frac{b}{s-3} = 1 - \frac{0.2}{s+2} + \frac{3.2}{s-3} \\ f(t) &= \delta(t) + (3.2e^{3t} - 0.2e^{-2t})u(t) \end{aligned}$$

(d)

$$F(s) = \frac{5}{s^2(s+2)} = \frac{k}{s} + \frac{2.5}{s^2} + \frac{1.25}{s+2}$$

To find  $k$  set  $s = 1$  on both sides to obtain

$$\frac{5}{3} = k + 2.5 + \frac{5}{12} \implies k = -1.25$$

and

$$\begin{aligned} F(s) &= -\frac{1.25}{s} + \frac{2.5}{s^2} + \frac{1.25}{s+2} \\ f(t) &= 1.25(-1 + 2t + e^{-2t})u(t) \end{aligned}$$

(e)

$$F(s) = \frac{2s+1}{(s+1)(s^2+2s+2)} = \frac{-1}{s+1} + \frac{As+B}{s^2+2s+2}$$

Multiply both sides by  $s$  and let  $s \rightarrow \infty$ . This yields

$$0 = -1 + A \implies A = 1$$

Setting  $s = 0$  on both sides yields

$$\frac{1}{2} = -1 + \frac{B}{2} \implies B = 3$$

$$F(s) = -\frac{1}{s+1} + \frac{s+3}{s^2+2s+2}$$

In the second fraction,  $A = 1$ ,  $B = 3$ ,  $a = 1$ ,  $c = 2$ ,  $b = \sqrt{2-1} = 1$ .

$$r = \sqrt{\frac{2+9-6}{2-1}} = \sqrt{5} \quad \theta = \tan^{-1}\left(\frac{-2}{1}\right) = -63.4^\circ$$

$$f(t) = [-e^{-t} + \sqrt{5}e^{-t} \cos(t - 63.4^\circ)]u(t)$$

(f)

$$F(s) = \frac{s+2}{s(s+1)^2} = \frac{2}{s} + \frac{k}{s+1} - \frac{1}{(s+1)^2}$$

To compute  $k$ , multiply both sides by  $s$  and let  $s \rightarrow \infty$ . This yields

$$0 = 2 + k + 0 \implies k = -2$$

and

$$F(s) = \frac{2}{s} - \frac{2}{s+1} - \frac{1}{(s+1)^2}$$

$$f(t) = [2 - (2+t)e^{-t}]u(t)$$

(g)

$$F(s) = \frac{1}{(s+1)(s+2)^4} = \frac{1}{s+1} + \frac{k_1}{s+2} + \frac{k_2}{(s+2)^2} + \frac{k_3}{(s+2)^3} - \frac{1}{(s+2)^4}$$

Multiplying both sides by  $s$  and let  $s \rightarrow \infty$ . This yields

$$0 = 1 + k_1 \implies k_1 = -1$$

$$\frac{1}{(s+1)(s+2)^4} = \frac{1}{s+1} - \frac{1}{s+2} + \frac{k_2}{(s+2)^2} + \frac{k_3}{(s+2)^3} - \frac{1}{(s+2)^4}$$

Setting  $s = 0$  and  $-3$  on both sides yields

$$\begin{aligned} \frac{1}{16} &= 1 - \frac{1}{2} + \frac{k_2}{4} + \frac{k_3}{8} - \frac{1}{16} \implies 4k_2 + 2k_3 = -6 \\ -\frac{1}{2} &= -\frac{1}{2} + 1 + k_2 - k_3 - 1 \implies k_2 - k_3 = 0 \end{aligned}$$

Solving these two equations simultaneously yields  $k_2 = k_3 = -1$ . Therefore

$$F(s) = \frac{1}{s+1} - \frac{1}{s+2} - \frac{1}{(s+2)^2} - \frac{1}{(s+2)^3} - \frac{1}{(s+2)^4}$$

$$f(t) = [e^{-t} - (1+t + \frac{t^2}{2} + \frac{t^3}{6})e^{-2t}]u(t)$$

Comment: This problem could be tackled in many ways. We could have used Eq. (B.64b), or after determining first two coefficients by Heaviside method, we could have cleared fractions. Also instead of letting  $s = 0$  and  $-3$ , we could have selected any other set of values. However, in this case these values appear most suitable for numerical work.

(h)

$$F(s) = \frac{s+1}{s(s+2)^2(s^2+4s+5)} = \frac{(1/20)}{s} + \frac{k}{s+2} + \frac{(1/2)}{(s+2)^2} + \frac{As+B}{s^2+4s+5}$$

Multiplying both sides by  $s$  and let  $s \rightarrow \infty$  yields

$$0 = \frac{1}{20} + k + A \implies k + A = -\frac{1}{20}$$

Setting  $s = 1$  and  $-1$  yields

$$\begin{aligned} \frac{2}{90} &= \frac{1}{20} + \frac{k}{3} + \frac{1}{18} + \frac{A+B}{10} \implies 20k + 6A + 6B = -5 \\ 0 &= -\frac{1}{20} + k + \frac{1}{2} + \frac{-A+B}{2} \implies 20k - 10A + 10B = -9 \end{aligned}$$

Solving these three equations in  $k$ ,  $A$  and  $B$  yields  $k = -\frac{1}{4}$ ,  $A = \frac{1}{5}$  and  $B = -\frac{1}{5}$ . Therefore

$$F(s) = \frac{1/20}{s} - \frac{1/4}{s+2} + \frac{(1/2)}{(s+2)^2} + \frac{1}{5} \left( \frac{s-1}{s^2+4s+5} \right)$$

For the last fraction in parenthesis on the right-hand side  $A = 1$ ,  $B = -1$ ,  $a = 2$ ,  $c = 5$ ,  $b = \sqrt{5-4} = 1$ .

$$r = \sqrt{\frac{5+1+4}{5-4}} = \sqrt{10} \quad \theta = \tan^{-1}\left(\frac{3}{1}\right) = 71.56^\circ$$

$$f(t) = \left[ \frac{1}{20} - \frac{1}{4}(1-2t)e^{-2t} + \frac{\sqrt{10}}{5}e^{-2t} \cos(t+71.56^\circ) \right] u(t)$$

(i)

$$F(s) = \frac{s^3}{(s+1)^2(s^2+2s+5)} = \frac{k}{s+1} - \frac{1/4}{(s+1)^2} + \frac{As+B}{s^2+2s+5}$$

Multiply both sides by  $s$  and let  $s \rightarrow \infty$  to obtain

$$1 = k + A$$

Setting  $s = 0$  and  $1$  yields

$$\begin{aligned} 0 &= k - \frac{1}{4} + \frac{B}{5} \implies 20k + 4B = 5 \\ \frac{1}{32} &= \frac{k}{2} - \frac{1}{16} + \frac{A+B}{8} \implies 16k + 4A + 4B = 3 \end{aligned}$$

Solving these three equations in  $k$ ,  $A$  and  $B$  yields  $k = \frac{3}{4}$ ,  $A = \frac{1}{4}$  and  $B = -\frac{5}{2}$ .

$$F(s) = \frac{3/4}{s+1} - \frac{1/4}{(s+1)^2} + \frac{1}{4} \left( \frac{s-10}{s^2+2s+5} \right)$$

For the last fraction in parenthesis,  $A = 1$ ,  $B = -10$ ,  $a = 1$ ,  $c = 5$ ,  $b = \sqrt{5-1} = 2$ .

$$r = \sqrt{\frac{5+100+20}{5-1}} = 5.59 \quad \theta = \tan^{-1}\left(\frac{11}{4}\right) = 70^\circ$$

Therefore

$$\begin{aligned} f(t) &= \left[ \left( \frac{3}{4} - \frac{1}{4}t \right) e^{-t} + \frac{5.59}{4} e^{-t} \cos(2t+70^\circ) \right] u(t) \\ &= \left[ \frac{1}{4}(3-t) + 1.3975 \cos(2t+70^\circ) \right] e^{-t} u(t) \end{aligned}$$

6.2-1 (a)

$$f(t) = u(t) - u(t-1)$$

and

$$\begin{aligned} F(s) &= \mathcal{L}[u(t)] - \mathcal{L}[u(t-1)] \\ &= \frac{1}{s} - e^{-s} \frac{1}{s} \\ &= \frac{1}{s} (1 - e^{-s}) \end{aligned}$$

(b)

$$f(t) = e^{-(t-\tau)} u(t-\tau)$$

$$F(s) = \frac{1}{s+1} e^{-s\tau}$$

(c)

$$f(t) = e^{-(t-\tau)} u(t) = e^\tau e^{-t} u(t)$$

$$\text{Therefore } F(s) = e^\tau \frac{1}{s+1}$$

(d)

$$f(t) = e^{-t} u(t-\tau) = e^{-\tau} e^{-(t-\tau)} u(t-\tau)$$

Observe that  $e^{-(t-\tau)} u(t-\tau)$  is  $e^{-t} u(t)$  delayed by  $\tau$ . Therefore

$$F(s) = e^{-\tau} \left( \frac{1}{s+1} \right) e^{-s\tau} = \left( \frac{1}{s+1} \right) e^{-(s+1)\tau}$$



(e)

$$\begin{aligned}
f(t) &= te^{-t}u(t-\tau) = (t-\tau+\tau)e^{-(t-\tau+\tau)}u(t-\tau) \\
&= e^{-\tau}[(t-\tau)e^{-(t-\tau)}u(t-\tau) + \tau e^{-(t-\tau)}u(t-\tau)]
\end{aligned}$$

Therefore

$$\begin{aligned}
F(s) &= e^{-\tau} \left[ \frac{1}{(s+1)^2} e^{-s\tau} + \frac{\tau}{(s+1)} e^{-s\tau} \right] \\
&= \frac{e^{-(s+1)\tau} [1 + \tau(s+1)]}{(s+1)^2}
\end{aligned}$$

(f)

$$f(t) = \sin \omega_0(t-\tau)u(t-\tau)$$

Note that this is  $\sin \omega_0 t$  shifted by  $\tau$ ; hence

$$F(s) = \left( \frac{\omega_0}{s^2 + \omega_0^2} \right) e^{-s\tau}$$

(g)

$$f(t) = \sin \omega_0(t-\tau)u(t) = [\sin \omega_0 t \cos \omega_0 \tau - \cos \omega_0 t \sin \omega_0 \tau]u(t)$$

$$F(s) = \frac{\omega_0 \cos \omega_0 \tau - s \sin \omega_0 \tau}{s^2 + \omega_0^2}$$

(h)

$$\begin{aligned}
f(t) &= \sin \omega_0 t u(t-\tau) = \sin[\omega_0(t-\tau+\tau)]u(t-\tau) \\
&= \cos \omega_0 \tau \sin[\omega_0(t-\tau)]u(t-\tau) + \sin \omega_0 \tau \cos[\omega_0(t-\tau)]u(t-\tau)
\end{aligned}$$

Therefore

$$F(s) = \left[ \cos \omega_0 \tau \left( \frac{\omega_0}{s^2 + \omega_0^2} \right) + \sin \omega_0 \tau \left( \frac{s}{s^2 + \omega_0^2} \right) \right] e^{-s\tau}$$

6.2-2 (a)

$$f(t) = t[u(t) - u(t-1)] = tu(t) - (t-1)u(t-1) - u(t-1)$$

$$F(s) = \frac{1}{s^2} - \frac{1}{s^2} e^{-s} - \frac{1}{s} e^{-s}$$

(b)

$$f(t) = \sin t u(t) + \sin(t-\pi) u(t-\pi)$$

$$F(s) = \frac{1}{s^2 + 1} (1 + e^{-\pi s})$$

(c)

$$\begin{aligned}
f(t) &= t[u(t) - u(t-1)] + e^{-t}u(t-1) \\
&= tu(t) - (t-1)u(t-1) - u(t-1) + e^{-1}e^{-(t-1)}u(t-1)
\end{aligned}$$

Therefore

$$F(s) = \frac{1}{s^2} (1 - e^{-s} - se^{-s}) + \frac{e^{-s}}{e(s+1)}$$

6.2-3 (a)

$$F(s) = \frac{(2s+5)e^{-2s}}{s^2+5s+6} = \hat{F}(s)e^{-2s}$$

It is clear that  $f(t) = \hat{f}(t-2)$ .

$$\begin{aligned}\hat{F}(s) &= \frac{2s+5}{s^2+5s+6} = \frac{2s+5}{(s+2)(s+3)} = \frac{1}{s+2} + \frac{1}{s+3} \\ \hat{f}(t) &= (e^{-2t} + e^{-3t})u(t) \\ f(t) &= \hat{f}(t-2) = [e^{-2(t-2)} + e^{-3(t-2)}]u(t-2)\end{aligned}$$

(b)

$$F(s) = \frac{s}{s^2+2s+2}e^{-3s} + \frac{2}{s^2+2s+2} = F_1(s)e^{-3s} + F_2(s)$$

where

$$F_1(s) = \frac{s}{s^2+2s+2} \quad \left\{ \begin{array}{l} A=1, B=0, a=1, c=2, b=1 \\ r=\sqrt{2}, \theta = \tan^{-1}(1) = \pi/4 \end{array} \right.$$

$$f_1(t) = \sqrt{2}e^{-t} \cos(t + \frac{\pi}{4})$$

$$F_2(s) = \frac{2}{s^2+2s+2} \quad \text{and} \quad f_2(t) = 2e^{-t} \sin t$$

Also

$$\begin{aligned}f(t) &= f_1(t-3) + f_2(t) \\ &= \sqrt{2}e^{-(t-3)} \cos(t-3 + \frac{\pi}{4})u(t-3) + 2e^{-t} \sin t u(t)\end{aligned}$$

(c)

$$\begin{aligned}F(s) &= \frac{(e)e^{-s}}{s^2-2s+5} + \frac{3}{s^2-2s+5} \\ &= e \frac{1}{s^2-2s+5} e^{-s} + \frac{3}{s^2-2s+5} \\ &= eF_1(s)e^{-s} + F_2(s)\end{aligned}$$

where

$$\begin{aligned}F_1(s) &= \frac{1}{s^2-2s+2} \quad \text{and} \quad f_1(t) = \frac{1}{2}e^t \sin 2t u(t) \\ F_2(s) &= \frac{3}{s^2-2s+2} \quad \text{and} \quad f_2(t) = \frac{3}{2}e^t \sin 2t u(t)\end{aligned}$$

Therefore

$$\begin{aligned}f(t) &= ef_1(t-1) + f_2(t) \\ &= \frac{e}{2}e^{(t-1)} \sin 2(t-1)u(t-1) + \frac{3}{2}e^t \sin 2t u(t)\end{aligned}$$

(d)

$$\begin{aligned}F(s) &= \frac{e^{-s} + e^{-2s} + 1}{s^2+3s+2} = (e^{-s} + e^{-2s} + 1) \left[ \frac{1}{s^2+3s+2} \right] \\ &= (e^{-s} + e^{-2s} + 1) \left[ \frac{1}{s+1} - \frac{1}{s+2} \right]\end{aligned}$$

$$F(s) = (e^{-s} + e^{-2s} + 1)\hat{F}(s)$$

where

$$\hat{F}(s) = \frac{1}{s+1} - \frac{1}{s+2} \quad \text{and} \quad \hat{f}(t) = (e^{-t} - e^{-2t})u(t)$$

Moreover

$$\begin{aligned}f(t) &= \hat{f}(t-1) + \hat{f}(t-2) + \hat{f}(t) \\ &= [e^{-(t-1)} - e^{-2(t-1)}]u(t-1) + [e^{-(t-2)} - e^{-2(t-2)}]u(t-2) + (e^{-t} - e^{-2t})u(t)\end{aligned}$$

6.2-4 (a)

and

$$g(t) = f(t) + f(t - T_0) + f(t - 2T_0) + \dots$$

$$\begin{aligned} G(s) &= F(s) + F(s)e^{-sT_0} + F(s)e^{-2sT_0} + \dots \\ &= F(s)[1 + e^{-sT_0} + e^{-2sT_0} + e^{-3sT_0} + \dots] \\ &= \frac{F(s)}{1 - e^{-sT_0}} \quad |e^{-sT_0}| < 1 \text{ or } \operatorname{Re} s > 0 \end{aligned}$$

(b)

$$\begin{aligned} f(t) &= u(t) - u(t - 2) \quad \text{and} \quad F(s) = \frac{1}{s}(1 - e^{-2s}) \\ G(s) &= \frac{F(s)}{1 - e^{-8s}} = \frac{1}{s} \left( \frac{1 - e^{-2s}}{1 - e^{-8s}} \right) \end{aligned}$$

6.2-5 Pair 2

$$u(t) = \int_{0^-}^t \delta(\tau) d\tau \iff \frac{1}{s}(1) = \frac{1}{s}$$

Pair 3

$$tu(t) = \int_{0^-}^t u(\tau) d\tau \iff \frac{1}{s} \left( \frac{1}{s} \right) = \frac{1}{s^2}$$

Pair 4: Use successive integration of  $tu(t)$

Pair 5: From frequency-shifting (6.33), we have

$$u(t) \iff \frac{1}{s} \quad \text{and} \quad e^{\lambda t} u(t) \iff \frac{1}{s - \lambda}$$

Pair 6: Because

$$tu(t) \iff \frac{1}{s^2} \quad \text{and} \quad te^{\lambda t} u(t) \iff \frac{1}{(s - \lambda)^2}$$

Pair 7: Apply the same argument to  $t^2u(t)$ ,  $t^3u(t)$ , ..., and so on.

Pair 8a:

$$\cos bt u(t) = \frac{1}{2}(e^{jbt} + e^{-jbt})u(t) \iff \frac{1}{2} \left( \frac{1}{s - jb} + \frac{1}{s + jb} \right) = \frac{s}{s^2 + b^2}$$

Pair 8b: Same way as the pair 8a.

Pair 9a: Application of the frequency-shift property (6.33) to pair 8a  $\cos bt u(t) \iff \frac{s}{s^2 + b^2}$  yields

$$e^{-at} \cos bt u(t) \iff \frac{s + a}{(s + a)^2 + b^2}$$

Pair 9b: Similar to the pair 9a.

Pairs 10a and 10b: Recognize that

$$re^{-at} \cos(bt + \theta) = re^{-at} [\cos \theta \cos bt - \sin \theta \sin bt]$$

Now use results in pairs 9a and 9b to obtain pair 10a. Pair 10b is equivalent to pair 10a.

6.2-6 (a) (i)

$$\begin{aligned} \frac{df}{dt} &= \delta(t) - \delta(t - 2) \\ sF(s) &= 1 - e^{-2s} \\ F(s) &= \frac{1}{s}(1 - e^{-2s}) \end{aligned}$$

(ii)

$$\begin{aligned} \frac{df}{dt} &= \delta(t - 2) - \delta(t - 4) \\ sF(s) &= e^{-2s} - e^{-4s} \\ F(s) &= \frac{1}{s}(e^{-2s} - e^{-4s}) \end{aligned}$$

(b)

$$\begin{aligned}\frac{df}{dt} &= u(t) - 3u(t-2) + 2u(t-3) \\ sF(s) &= \frac{1}{s} - \frac{3}{s}e^{-2s} + \frac{2}{s}e^{-3s} \quad [f(0^-) = 0] \\ F(s) &= \frac{1}{s^2}(1 - 3e^{-2s} + 2e^{-3s})\end{aligned}$$

6.3-1 (a)

$$\begin{aligned}(s^2 + 3s + 2)Y(s) &= s\left(\frac{1}{s}\right) \\ Y(s) &= \frac{1}{s^2 + 3s + 2} = \frac{1}{s+1} - \frac{1}{s+2} \\ y(t) &= (e^{-t} - e^{-2t})u(t)\end{aligned}$$

(b)

$$(s^2Y(s) - 2s - 1) + 4(sY(s) - 2) + 4Y(s) = (s+1)\frac{1}{s+1}$$

or

$$(s^2 + 4s + 4)Y(s) = 2s + 10$$

and

$$\begin{aligned}Y(s) &= \frac{2s + 10}{s^2 + 4s + 4} = \frac{2s + 10}{(s+2)^2} = \frac{2}{s+2} + \frac{6}{(s+2)^2} \\ y(t) &= (2 + 6t)e^{-2t}u(t)\end{aligned}$$

(c)

$$(s^2Y(s) - s - 1) + 6(sY(s) - 1) + 25Y(s) = (s+2)\frac{25}{s} = 25 + \frac{50}{s}$$

or

$$(s^2 + 6s + 25)Y(s) = s + 32 + \frac{50}{s} = \frac{s^2 + 32s + 50}{s}$$

and

$$\begin{aligned}Y(s) &= \frac{s^2 + 32s + 50}{s(s^2 + 6s + 25)} = \frac{2}{s} + \frac{-s + 20}{s^2 + 6s + 25} \\ y(t) &= [2 + 5.836e^{-3t} \cos(4t - 99.86^\circ)]u(t)\end{aligned}$$

6.3-2 (a) All initial conditions are zero. The zero-input response is zero. The entire response found in Prob. 6.3-2a is zero-state response, that is

$$\begin{aligned}y_{zs}(t) &= (e^{-t} - e^{-2t})u(t) \\ y_{zi}(t) &= 0\end{aligned}$$

(b) The Laplace transform of the differential equation is

$$(s^2Y(s) - 2s - 1) + 4(sY(s) - 2) + 4Y(s) = (s+1)\frac{1}{s+1}$$

or

$$(s^2 + 4s + 4)Y(s) - (2s + 9) = 1$$

or

$$(s^2 + 4s + 4)Y(s) = \underbrace{2s + 9}_{\text{i.c. terms}} + \underbrace{1}_{\text{input}}$$

$$\begin{aligned}Y(s) &= \underbrace{\frac{2s + 9}{s^2 + 4s + 4}}_{\text{zero-input}} + \underbrace{\frac{1}{s^2 + 4s + 4}}_{\text{zero-state}} \\ &= \underbrace{\frac{2}{s+2}}_{\text{zero-input}} + \underbrace{\frac{5}{(s+2)^2}}_{\text{zero-input}} + \underbrace{\frac{1}{(s+2)^2}}_{\text{zero-state}}\end{aligned}$$

$$y(t) = \underbrace{(2 + 5t)e^{-2t}}_{\text{zero-input}} + \underbrace{te^{-2t}}_{\text{zero-state}}$$

(c) The Laplace transform of the equation is

$$(s^2 Y(s) - s - 1) + 6(sY(s) - 1) + 25Y(s) = 25 + \frac{50}{s}$$

or

$$(s^2 + 6s + 25)Y(s) = \underbrace{s + 7}_{\text{i.c. terms}} + \underbrace{25 + \frac{50}{s}}_{\text{input}}$$

$$\begin{aligned} Y(s) &= \underbrace{\frac{s + 7}{s^2 + 6s + 25}}_{\text{zero-input}} + \underbrace{\frac{25s + 50}{s(s^2 + 6s + 25)}}_{\text{zero-state}} \\ &= \left( \frac{s + 7}{s^2 + 6s + 25} \right) + \left( \frac{2}{s} + \frac{-2s + 13}{s^2 + 6s + 25} \right) \\ y(t) &= \underbrace{[\sqrt{2}e^{-3t} \cos(4t - \frac{\pi}{4})]}_{\text{zero-input}} + \underbrace{[2 + 5.154e^{-3t} \cos(4t - 112.83^\circ)]}_{\text{zero-state}} \end{aligned}$$

6.3-3 (a) Laplace transform of the two equations yields

$$\begin{aligned} (s + 3)Y_1(s) - 2Y_2(s) &= \frac{1}{s} \\ -2Y_1(s) + (2s + 4)Y_2(s) &= 0 \end{aligned}$$

Using Cramer's rule, we obtain

$$\begin{aligned} Y_1(s) &= \frac{s + 2}{s(s^2 + 5s + 4)} = \frac{s + 2}{s(s + 1)(s + 4)} = \frac{1/2}{s} - \frac{1/3}{s + 1} - \frac{1/6}{s + 4} \\ Y_2(s) &= \frac{1}{s(s^2 + 5s + 4)} = \frac{1}{s(s + 1)(s + 4)} = \frac{1/4}{s} - \frac{1/3}{s + 1} + \frac{1/12}{s + 4} \end{aligned}$$

and

$$\begin{aligned} y_1(t) &= \left( \frac{1}{2} - \frac{1}{3}e^{-t} - \frac{1}{6}e^{-4t} \right) u(t) \\ y_2(t) &= \left( \frac{1}{4} - \frac{1}{3}e^{-t} + \frac{1}{12}e^{-4t} \right) u(t) \end{aligned}$$

If  $H_1(s)$  and  $H_2(s)$  are the transfer functions relating  $y_1(t)$  and  $y_2(t)$ , respectively to the input  $f(t)$ , thus

$$H_1(s) = \frac{s + 2}{s^2 + 5s + 4} \quad \text{and} \quad H_2(s) = \frac{1}{s^2 + 5s + 4}$$

(b) The Laplace transform of the equations are

$$\begin{aligned} (s + 2)Y_1(s) - (s + 1)Y_2(s) &= 0 \\ -(s + 1)Y_1(s) + (2s + 1)Y_2(s) &= 0 \end{aligned}$$

Application of Cramer's rule yields

$$\begin{aligned} Y_1(s) &= \frac{s + 1}{s(s^2 + 3s + 1)} = \frac{s + 1}{s(s + 0.382)(s + 2.618)} = \frac{1}{s} - \frac{0.724}{s + 0.382} - \frac{0.276}{s + 2.618} \\ Y_2(s) &= \frac{s + 2}{s(s^2 + 3s + 1)} = \frac{s + 2}{s(s + 0.382)(s + 2.618)} = \frac{2}{s} - \frac{1.894}{s + 0.382} - \frac{0.1056}{s + 2.618} \end{aligned}$$

$$H_1(s) = \frac{s + 1}{s^2 + 3s + 1} \quad \text{and} \quad H_2(s) = \frac{s + 2}{s^2 + 3s + 1}$$

$$\begin{aligned} y_1(t) &= (1 - 0.724e^{-0.382t} - 0.276e^{-2.618t})u(t) \\ y_2(t) &= (2 - 1.894e^{-0.382t} - 0.1056e^{-2.618t})u(t) \end{aligned}$$

6.3-4 At  $t = 0^-$ , the inductor current  $y_1(0) = 4$  and the capacitor voltage is 16 volts. After  $t = 0$ , the loop equations are

$$2\frac{dy_1}{dt} - 2\frac{dy_2}{dt} + 5y_1(t) - 4y_2(t) = 40$$

$$-2\frac{dy_1}{dt} - 4y_1(t) + 2\frac{dy_2}{dt} + 4y_2(t) + \int_{-\infty}^t y_2(\tau) d\tau = 0$$

If

$$y_1(t) \iff Y_1(s), \quad \frac{dy_1}{dt} = sY_1(s) - 4$$

$$y_2(t) \iff Y_2(s), \quad \frac{dy_2}{dt} = sY_2(s)$$

$$\int_{-\infty}^t y_2(\tau) d\tau \iff \frac{1}{s}Y_2(s) + \frac{16}{s}$$

Laplace transform of the loop equations are

$$2(sY_1(s) - 4) - 2sY_2(s) + 5Y_1(s) - 4Y_2(s) = \frac{40}{s}$$

$$-2(sY_1(s) - 4) - 4Y_1(s) + 2sY_2(s) + 4Y_2(s) + \frac{1}{s}Y_2(s) + \frac{16}{s} = 0$$

Or

$$(2s + 5)Y_1(s) - (2s + 4)Y_2(s) = 8 + \frac{40}{s}$$

$$-(2s + 4)Y_1(s) + (2s + 4 + \frac{1}{s})Y_2(s) = -8 - \frac{16}{s}$$

Cramer's rule yields

$$Y_1(s) = \frac{4(6s^2 + 13s + 5)}{s(s^2 + 3s + 2.5)} = \frac{8}{s} + \frac{16s + 28}{s^2 + 3s + 2.5}$$

$$y_1(t) = [8 + 17.89e^{-1.5t} \cos(\frac{t}{2} - 26.56^\circ)]u(t)$$

$$Y_2(s) = \frac{20(s + 2)}{(s^2 + 3s + 2.5)}$$

$$y_2(t) = 20\sqrt{2}e^{-1.5t} \cos(\frac{t}{2} - \frac{\pi}{4})u(t)$$

6.3-5 (a)  $\frac{5s+3}{s^2+11s+24}$  (b)  $\frac{3s^2+7s+5}{s^3+6s^2-11s+6}$  (c)  $\frac{3s+2}{s(s^3+4)}$

6.3-6 (a)

$$\frac{d^2y}{dt^2} + 3\frac{dy}{dt} + 8y(t) = \frac{df}{dt} + 5f(t)$$

(b)

$$\frac{d^3y}{dt^3} + 8\frac{d^2y}{dt^2} + 5\frac{dy}{dt} + 7y(t) = \frac{d^2f}{dt^2} + 3\frac{df}{dt} + 5f(t)$$

(c)

$$\frac{d^2y}{dt^2} - 2\frac{dy}{dt} + 5y(t) = 5\frac{d^2f}{dt^2} + 7\frac{df}{dt} + 2f(t)$$

6.3-7 (a) (i)  $F(s) = \frac{1}{s+3}$  and

$$Y(s) = \frac{s+5}{(s+3)(s^2+5s+6)} = \frac{s+5}{(s+2)(s+3)^2} = \frac{3}{s+2} - \frac{3}{s+3} - \frac{2}{(s+3)^2}$$

$$y(t) = (3e^{-2t} - 3e^{-3t} - 2te^{-3t})u(t)$$

(ii)  $F(s) = \frac{1}{s+4}$

$$Y(s) = \frac{s+5}{(s+2)(s+3)(s+4)} = \frac{3/2}{s+2} - \frac{2}{s+3} + \frac{1/2}{s+4}$$

$$y(t) = \frac{3}{2}e^{-2t} - 2e^{-3t} + \frac{1}{2}e^{-4t}u(t)$$

(iii) The input here is the input in (ii) delayed by 5 secs. Therefore  $F(s) = \frac{1}{s+4}e^{-5s}$

$$Y(s) = \frac{s+5}{(s+2)(s+3)(s+4)}e^{-5s} = \left[ \frac{3/2}{s+2} - \frac{2}{s+3} + \frac{1/2}{s+4} \right] e^{-5s}$$

$$y(t) = \left[ \frac{3}{2}e^{-2(t-5)} - 2e^{-3(t-5)} + \frac{1}{2}e^{-4(t-5)} \right] u(t-5)$$

(iv) The input here is equal to the input in (ii) multiplied by  $e^{20}$  because  $e^{-4(t-5)} = e^{20}e^{-4t}$ . Therefore the output is equal to the output in (ii) multiplied by  $e^{20}$ .

$$y(t) = e^{20} \left[ \frac{3}{2}e^{-2t} - 2e^{-3t} + \frac{1}{2}e^{-4t} \right] u(t)$$

(v) The input here is equal to the input in (iii) multiplied by  $e^{-20}$  because  $e^{-4t}u(t-5) = e^{-20}e^{-4(t-5)}u(t-5)$ . Therefore

$$y(t) = e^{-20} \left[ \frac{3}{2}e^{-2(t-5)} - 2e^{-3(t-5)} + \frac{1}{2}e^{-4(t-5)} \right] u(t-5)$$

(b)  $(D^2 + 2D + 5)y(t) = (2D + 3)f(t)$

6.3-8 (a)  $F(s) = \frac{10}{s}$

$$Y(s) = \frac{10(2s+3)}{s(s^2+2s+5)} = \frac{6}{s} + \frac{-6s+8}{s^2+2s+5}$$

$$y(t) = [6 + 9.22e^{-t} \cos(2t - 130.6^\circ)] u(t)$$

(b)  $f(t) = u(t-5)$  and  $F(s) = \frac{1}{s}e^{-5s}$

$$Y(s) = \frac{2s+3}{s(s^2+2s+5)}e^{-5s} = \left[ \frac{0.6}{s} + \frac{1}{10} \left( \frac{-6s+8}{s^2+2s+5} \right) \right] e^{-5s}$$

$$y(t) = \frac{1}{10} [6 + 9.22e^{-(t-5)} \cos[2(t-5) - 130.6^\circ]] u(t-5)$$

6.3-9  $F(s) = \frac{1}{s(s+1)}$

$$Y(s) = \frac{1}{(s^2+9)(s+1)} = \frac{0.1}{s+1} - \frac{0.1(s-1)}{s^2-9} \quad \text{and} \quad y(t) = \left( 0.1e^{-t} - \frac{1}{3\sqrt{10}} \cos \left[ 3t + \tan^{-1} \left( \frac{1}{3} \right) \right] \right) u(t)$$

6.3-10 (a) Let  $H(s)$  be the system transfer function.

$$Y(s) = F(s)H(s)$$

Consider an input  $f_1(t) = \dot{f}(t)$ . Then  $F_1(s) = sF(s)$ . If the output is  $y_1(t)$  and its transform is  $Y_1(s)$ , then

$$Y_1(s) = F_1(s)H(s) = sF(s)H(s) = sY(s)$$

This shows that  $y_1(t) = dy/dt$ .

(b) Using similar argument we show that for the input  $\int_0^t f(\tau) d\tau$ , the output is  $\int_0^t y(\tau) d\tau$ . Because  $u(t)$  is an integral of  $\delta(t)$ , the unit step response is the integral of the unit impulse response  $h(t)$ .

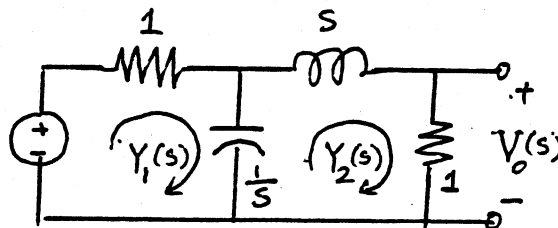

Fig. S6.4-1

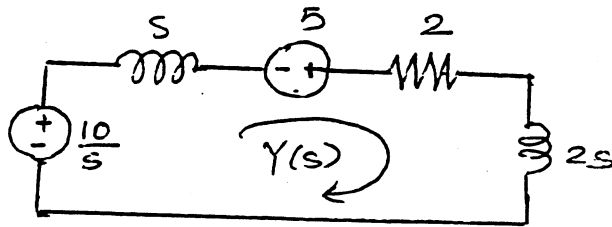

Fig. S6.4-2

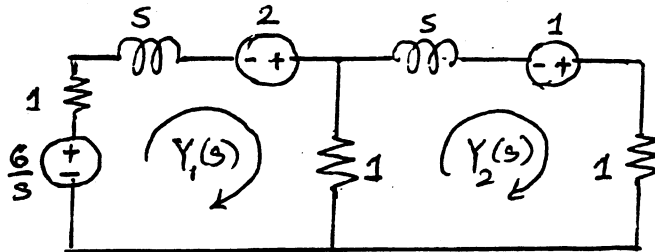

Fig. S6.4-4

6.4-1 Figure S6.4-1 shows the transformed network. The loop equations are

$$\begin{aligned} \left(1 + \frac{1}{s}\right)Y_1(s) - \frac{1}{s}Y_2(s) &= \frac{1}{(s+1)^2} \\ -\frac{1}{s}Y_1(s) + \left(s+1 + \frac{1}{s}\right)Y_2(s) &= 0 \end{aligned}$$

or

$$\begin{bmatrix} \frac{s+1}{s} & -\frac{1}{s} \\ -\frac{1}{s} & \frac{s^2+s+1}{s} \end{bmatrix} \begin{bmatrix} Y_1(s) \\ Y_2(s) \end{bmatrix} = \begin{bmatrix} \frac{1}{(s+1)^2} \\ 0 \end{bmatrix}$$

Cramer's rule yields

$$\begin{aligned} Y_2(s) &= \frac{1}{(s+1)^2(s^2+2s+2)} = \frac{1}{(s+1)^2} - \frac{1}{s^2+2s+2} \\ v_0(t) = y_2(t) &= (te^{-t} - \frac{1}{2}e^{-t} \sin t)u(t) \end{aligned}$$

6.4-2 Before the switch is opened, the inductor current is 5A, that is  $y(0) = 5$ . Figure S6.4-2b shows the transformed circuit for  $t \geq 0$  with initial condition generator. The current  $Y(s)$  is given by

$$\begin{aligned} Y(s) &= \frac{(10/s) + 5}{3s+2} = \frac{5s+10}{s(3s+2)} = \frac{5}{3} \left[ \frac{3}{s} - \frac{2}{s+(2/3)} \right] \\ y(t) &= \left(5 - \frac{10}{3}e^{-2t/3}\right)u(t) \end{aligned}$$

6.4-3 The impedance seen by the source  $f(t)$  is

$$Z(s) = \frac{Ls(1/Cs)}{Ls + (1/Cs)} = \frac{Ls}{LCs^2 + 1} = \frac{Ls\omega_0^2}{s^2 + \omega_0^2}$$

The current  $Y(s)$  is given by

$$Y(s) = \frac{F(s)}{Z(s)} = \frac{s^2 + \omega_0^2}{Ls\omega_0^2} F(s)$$

(a)

$$F(s) = \frac{As}{s^2 + \omega_0^2}, \quad Y(s) = \frac{A}{L\omega_0^2} \quad \text{and} \quad y(t) = \frac{A}{L\omega_0^2} \delta(t)$$

(b)

$$F(s) = \frac{A\omega_0}{s^2 + \omega_0^2}, \quad Y(s) = \frac{A}{L\omega_0 s} \quad \text{and} \quad y(t) = \frac{A}{L\omega_0} u(t)$$



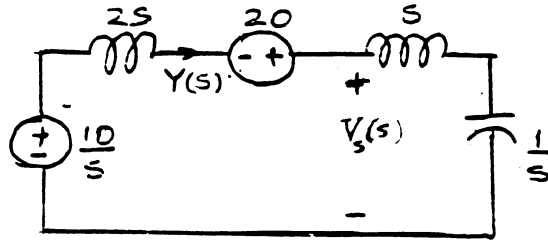

Fig. S6.4-5

6.4-4 At  $t = 0$ , the steady-state values of currents  $y_1$  and  $y_2$  is  $y_1(0) = 2$ ,  $y_2(0) = 1$ .

Figure S6.4-4 shows the transformed circuit for  $t \geq 0$  with initial condition generators. The loop equations are

$$\begin{aligned}(s+2)Y_1(s) - Y_2(s) &= 2 + \frac{6}{s} \\ -Y_1(s) + (s+2)Y_2(s) &= 1\end{aligned}$$

Cramer's rule yields

$$\begin{aligned}Y_1(s) &= \frac{2s^2 + 11s + 12}{s(s+1)(s+3)} = \frac{4}{s} - \frac{3/2}{s+1} - \frac{1/2}{s+3} \\ Y_2(s) &= \frac{s^2 + 4s + 6}{s(s+1)(s+3)} = \frac{2}{s} - \frac{3/2}{s+1} + \frac{1/2}{s+3}\end{aligned}$$

$$\begin{aligned}y_1(t) &= (4 - \frac{3}{2}e^{-t} - \frac{1}{2}e^{-3t})u(t) \\ y_2(t) &= (2 - \frac{3}{2}e^{-t} + \frac{1}{2}e^{-3t})u(t)\end{aligned}$$

6.4-5 The current in the 2H inductor at  $t = 0$  is 10A. The transformed circuit with initial condition generators is shown in Figure S6.4-5 for  $t \geq 0$ .

$$Y_1(s) = \frac{\frac{10}{s} + 20}{3s + \frac{1}{s} + 1} = \frac{20s + 10}{3s^2 + s + 1} = \frac{20}{s} \left[ \frac{s + 0.5}{s^2 + \frac{1}{3s} + \frac{1}{3}} \right]$$

Here  $A = 1$ ,  $B = 0.5$ ,  $a = \frac{1}{6}$ ,  $c = \frac{1}{3}$ ,  $b = \frac{\sqrt{11}}{6}$

$$r = \sqrt{\frac{15}{11}} = 1.168 \quad \theta = \tan^{-1}\left(\frac{-2}{\sqrt{11}}\right) = -31.1^\circ$$

$$\begin{aligned}y_1(t) &= \frac{20}{3}(1.168)e^{-t/6} \cos\left(\frac{\sqrt{11}}{6}t - 31.1^\circ\right)u(t) \\ &= 7.787e^{-t/6} \cos\left(\frac{\sqrt{11}}{6}t - 31.1^\circ\right)u(t)\end{aligned}$$

The voltage  $v_s(t)$  across the switch is

$$\begin{aligned}V_s(s) &= (s + \frac{1}{s})Y(s) = \left(\frac{s^2 + 1}{s}\right)\left(\frac{20s + 10}{3s^2 + s + 1}\right) = \frac{20(s^2 + 1)(s + 0.5)}{s(s^2 + \frac{1}{3s} + \frac{1}{3})} \\ &= \frac{20}{3} \left[ 1 + \frac{3/2}{s} + \frac{1}{6} \frac{-8s + 1}{s^2 + 1/3s + 1/3} \right] \\ v_s(t) &= \frac{20}{3}\delta(t) + [10 + 9.045e^{-t/6} \cos(\frac{\sqrt{11}}{6}t - 152.2^\circ)]u(t)\end{aligned}$$

6.4-6 Figure S6.4-6 shows the transformed circuit with mutually coupled inductor replaced by their equivalents (see Fig. 6.14b). The loop equations are

$$\begin{aligned}(s+1)Y_1(s) - 2sY_2(s) &= \frac{100}{s} \\ -2sY_1(s) + (4s+1)Y_2(s) &= 0\end{aligned}$$

Cramer's rule yields

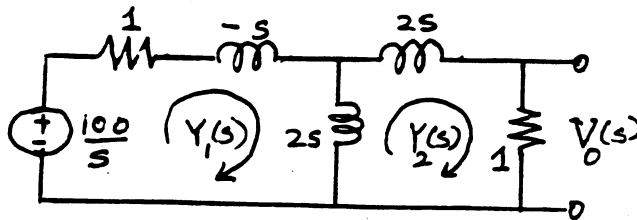

Fig. S6.4-6

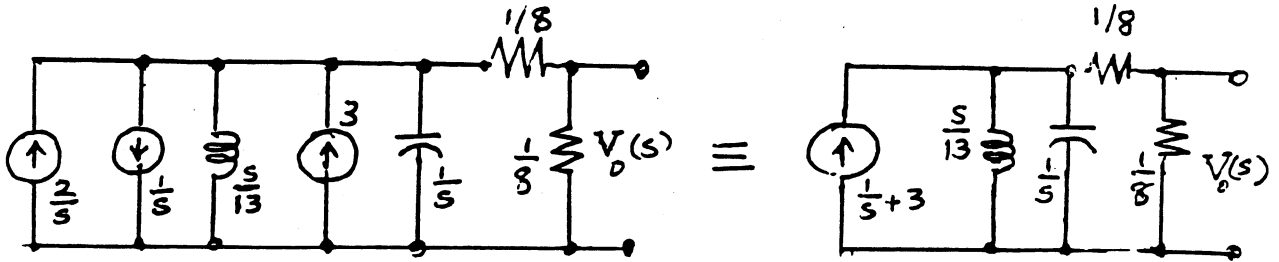

Fig. S6.4-7

$$Y_2(s) = \frac{40}{(s+0.2)}$$

and

$$v_0(t) = y_2(t) = 40e^{-t/5}u(t)$$

6.4-7 Figure S6.4-7 shows the transformed circuit with parallel form of initial condition generators. The admittance  $W(s)$  seen by the source is

$$W(s) = \frac{13}{s} + s + 4 = \frac{s^2 + 4s + 13}{s}$$

The voltage across terminals a b is

$$V_{ab}(s) = \frac{I(s)}{W(s)} = \frac{\frac{1}{s} + 3}{\frac{s^2 + 4s + 13}{s}} = \frac{3s + 1}{s^2 + 4s + 13}$$

Also

$$V_0(s) = \frac{1}{2}V_{ab}(s) = \frac{3s + 1}{2(s^2 + 4s + 13)}$$

and

$$v_0(t) = 1.716e^{-2t} \cos(3t + 29^\circ)u(t)$$

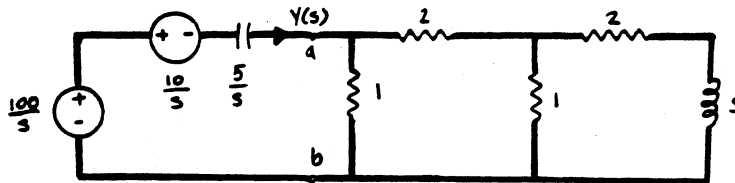

Fig. S6.4-8

6.4-8 The capacitor voltage at  $t = 0$  is 10 volts. The inductor current is zero. The transformed circuit with initial condition generators is shown for  $t > 0$  in Fig. S6.4-8.

To determine the current  $Y(s)$ , we determine  $Z_{ab}(s)$ , the impedance seen across terminals ab:

$$Z_{ab}(s) = \frac{1}{1 + \left( \frac{1}{2 + \frac{s+2}{s+3}} \right)} = \frac{3s + 8}{4s + 11}$$

Also

$$\begin{aligned}
 Y(s) &= \frac{90}{\frac{5}{s} + \left(\frac{3s+8}{4s+11}\right)} \\
 &= \frac{90(4s+11)}{3s^2 + 28s + 55} \\
 &= \frac{30(4s+11)}{s^2 + \frac{28}{3}s + \frac{55}{3}} \\
 &= \frac{30(4s+11)}{(s+2.8)(s+6.53)} \\
 &= -\frac{1.61}{s+2.8} + \frac{121.61}{s+6.53}
 \end{aligned}$$

and  $y(t) = [121.61e^{-6.53t} - 1.61e^{-2.8t}]u(t)$

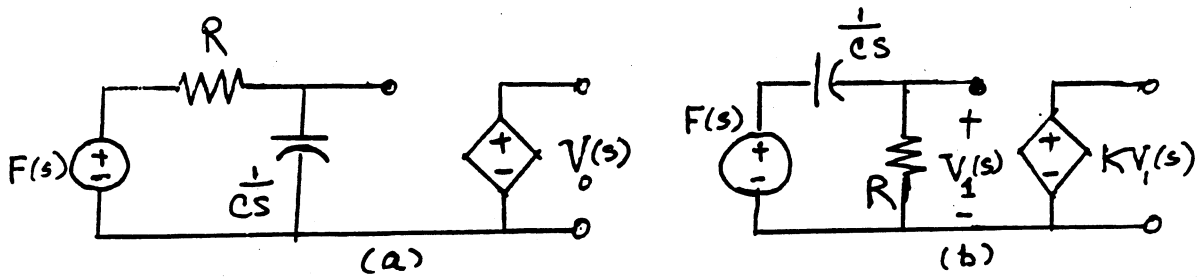

Fig. S6.4-9

6.4-9 Figure S6.4-9 shows the transformed circuit (with noninverting op amp replaced by its equivalent as shown in Fig. 6.16) from Fig. S6.4-9a

$$V_0(s) = KV_1(s) = K \frac{1}{Cs} R + \frac{1}{Cs} F(s) = \frac{Ka}{s+a} \quad a = \frac{1}{RC}$$

Therefore

$$H(s) = \frac{Ka}{s+a} \quad a = \frac{1}{RC}, \quad K = 1 + \frac{R_b}{R_a}$$

Similarly for the circuit in Fig. P6.4-9b, we can show (see Fig. S6.4-9)

$$H(s) = \frac{Ks}{s+a}$$

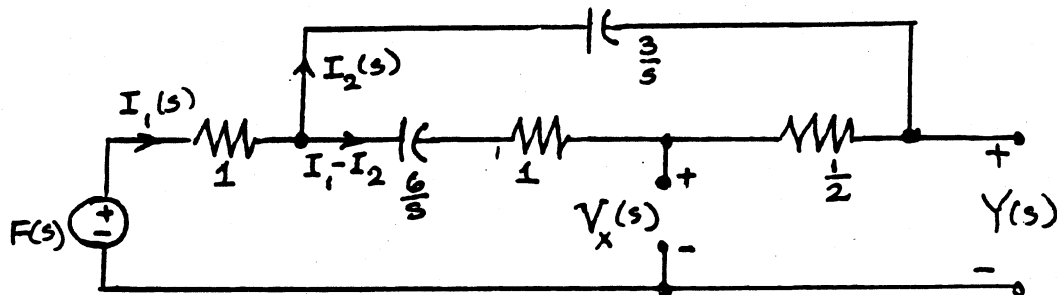

Fig. S6.4-10

6.4-10 Figure S6.4-10 shows the transformed circuit. The op amp input voltage is  $V_x(s) \simeq 0$ . The loop equations are

$$\begin{aligned}
 I_1(s) + \left(\frac{6}{s} + 1\right)[I_1(s) - I_2(s)] &= F(s) \\
 -\frac{3}{s}I_2(s) + \left(\frac{6}{s} + \frac{3}{2}\right)[I_1(s) - I_2(s)] &= 0
 \end{aligned}$$

Cramer's rule yields

$$I_1(s) = \frac{s(s+6)}{s^2+8s+12} F(s), \quad I_2(s) = \frac{s(s+4)}{s^2+8s+12}$$

$$Y(s) = -\frac{1}{2}[I_1(s) - I_2(s)] = \frac{-s}{s^2+8s+12} F(s)$$

The transfer function

$$H(s) = \frac{-s}{s^2+8s+12}$$

6.4-11 (a)

$$Y(s) = \frac{6s^2+3s+10}{s(2s^2+6s+5)}$$

$$y(0^+) = \lim_{s \rightarrow \infty} sY(s) = 3$$

$$y(\infty) = \lim_{s \rightarrow 0} sY(s) = 2$$

(b)

$$Y(s) = \frac{6s^2+3s+10}{(s+1)(2s^2+6s+5)}$$

$$y(0^+) = \lim_{s \rightarrow \infty} sY(s) = 3$$

$$y(\infty) = \lim_{s \rightarrow 0} sY(s) = 0$$

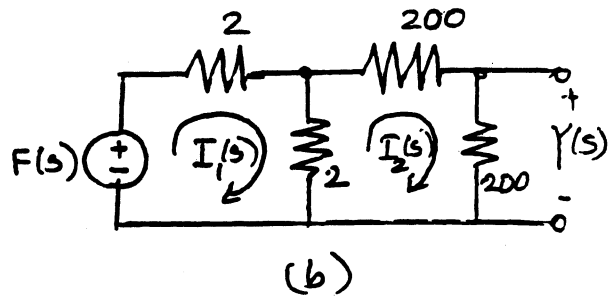
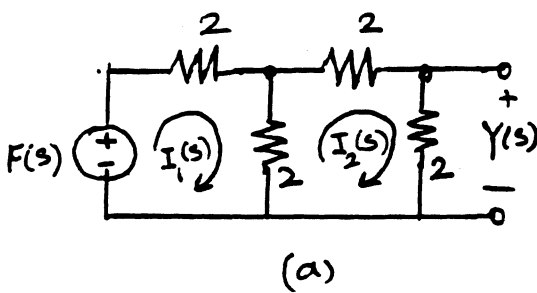

Figure S6.5-1

6.5-1 (a) The loop equations are

$$4I_1 - 2I_2 = F(s)$$

$$-2I_1 + 6I_2 = 0$$

Cramer's rule yields

$$I_2(s) = \frac{2}{20} F(s) = \frac{1}{10} F(s)$$

and

$$Y(s) = 2I_2(s) = \frac{1}{5} F(s)$$

Therefore  $H(s) = \frac{1}{5}$  not  $\frac{1}{4}$ .

(b)

$$4I_1 - 2I_2 = F(s)$$

$$-2I_1 + 400I_2 = 0$$

Cramer's rule yields

$$I_2(s) = \frac{2}{1596} F(s)$$

$$Y(s) = 200I_2(s) = \frac{400}{1596} F(s) = \frac{1}{3.99} F(s)$$

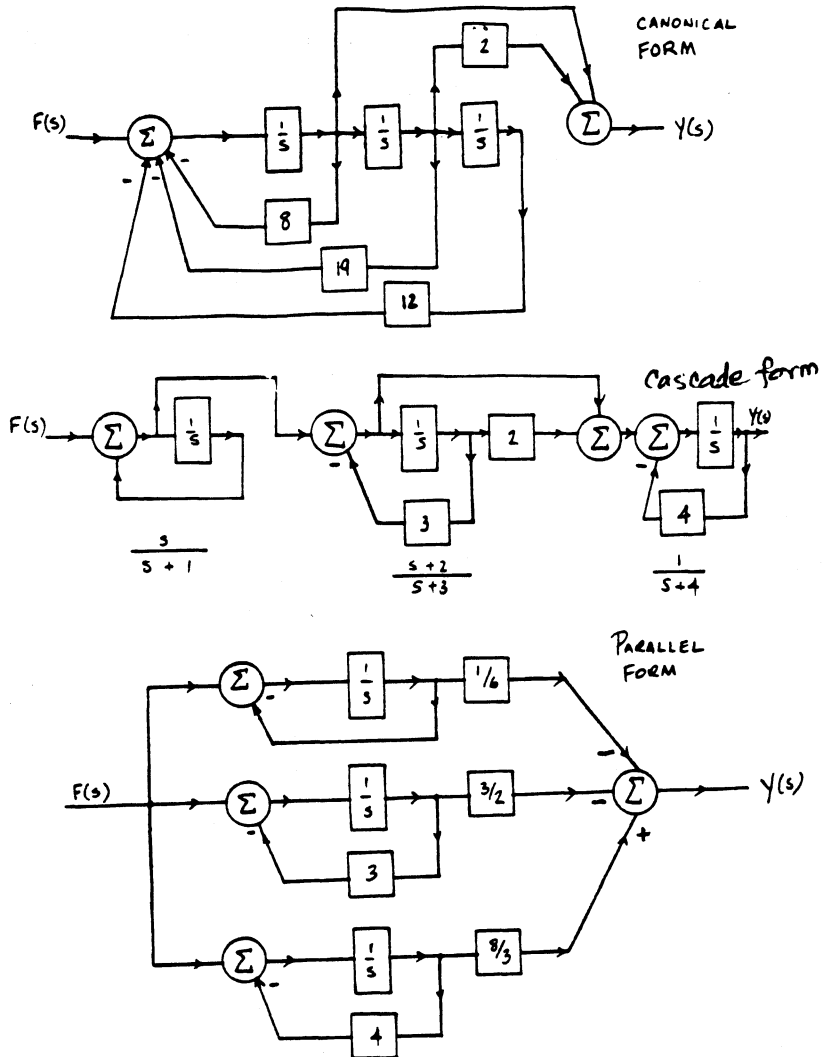

Fig. S6.6-1

In this case  $H(s)$  is very close to  $1/4$ . This is because the second ladder section causes a negligible load on the first. The Cascade rule applies only when the successive subsystems do not load the preceding subsystems.

6.5-2 To determine the impulse response of either system, we apply  $f(t) = \delta(t)$  at the input. The output  $y(t)$  is, by definition, the impulse response.

For series connection (Fig. 6.18b), if we apply  $f(t) = \delta(t)$  at the input, the output of  $H_1(s)$  is  $h_1(t)$ . This signal is applied to the input of  $H_2(s)$  with impulse response  $h_2(t)$ . Hence, the output of  $H_2(s)$  is  $h(t) = h_1(t) * h_2(t)$ .

For parallel connection (Fig. 6.18c), if we apply  $f(t) = \delta(t)$  at the input, the outputs of  $H_1(s)$  and  $H_2(s)$  are  $h_1(t)$  and  $h_2(t)$ , and the output of the summer is  $h(t) = h_1(t) + h_2(t)$ .

6.6-1

$$H(s) = \frac{s^2 + 2s}{s^3 + 8s^2 + 19s + 12} = \left(\frac{s}{s+1}\right) \left(\frac{s+2}{s+3}\right) \left(\frac{1}{s+4}\right) = \frac{-1/6}{s+1} - \frac{3/2}{s+3} + \frac{8/3}{s+4}$$

Also 
$$H(s) = \frac{b_3s^3 + b_2s^2 + b_1s + b_0}{s^3 + a_2s^2 + a_1s + a_0}$$

with  $a_0 = 12, a_1 = 19, a_2 = 8,$  and  $b_0 = 0, b_1 = 2, b_2 = 1.$  Figure S6.6-1 shows the canonical, series and parallel realizations.

6.6-2 (a)

$$H(s) = \frac{3s(s+2)}{(s+1)(s^2+2s+2)} = \frac{3s^2+6s}{s^3+3s^2+4s+2} = \left(\frac{3s}{s+1}\right) \left(\frac{s+2}{s^2+2s+2}\right) = -\frac{3}{s+1} + \frac{6s+6}{s^2+2s+2}$$

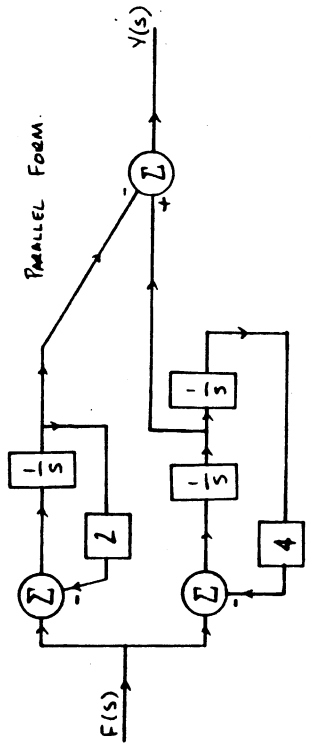
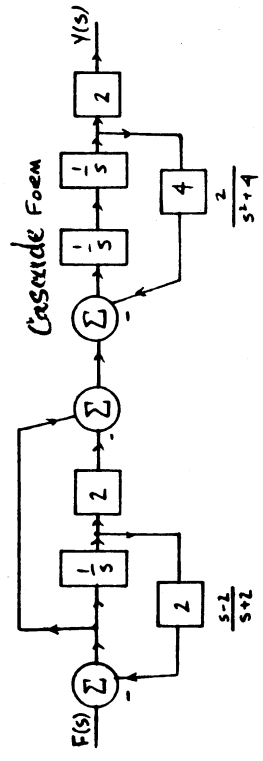
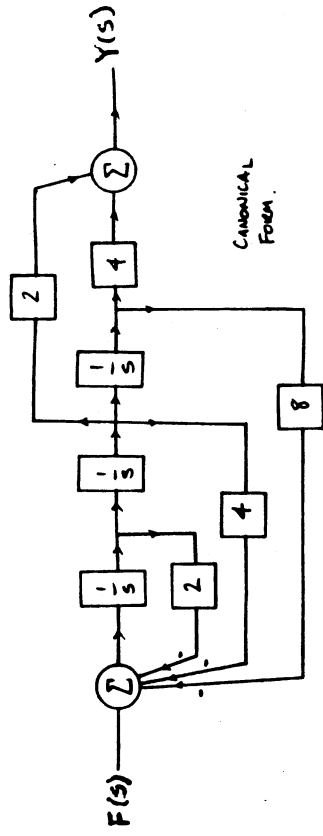

(b)

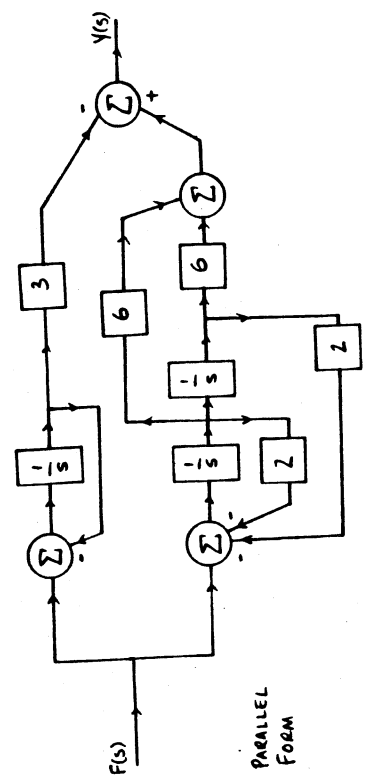
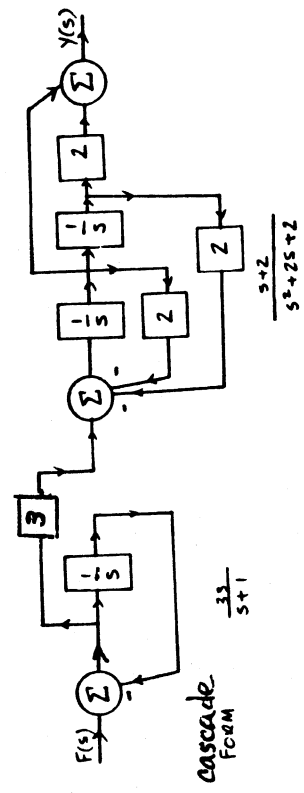
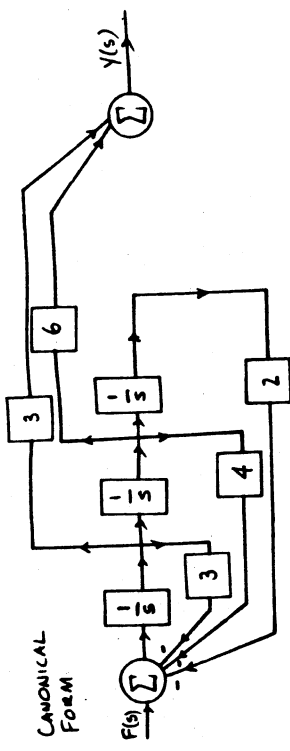

(a)

Figure S6.6-2

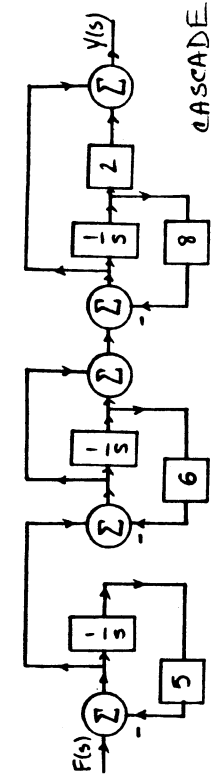
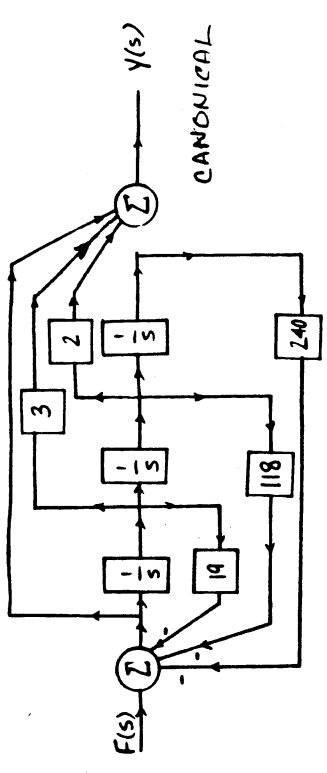

$$\frac{s}{s+5} \cdot \frac{s+1}{s+6} \cdot \frac{s+1}{s+8}$$

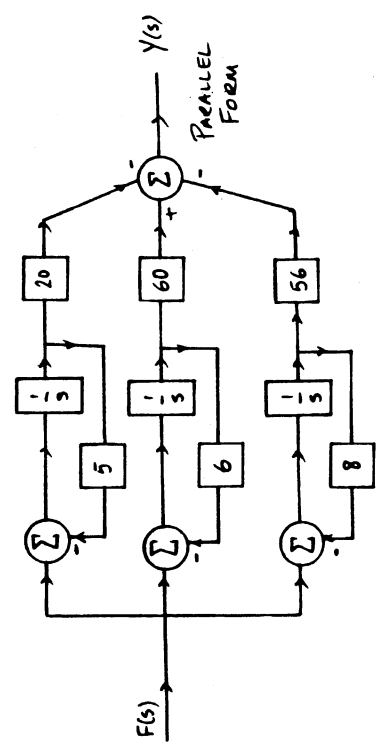

Fig. S6.6-4

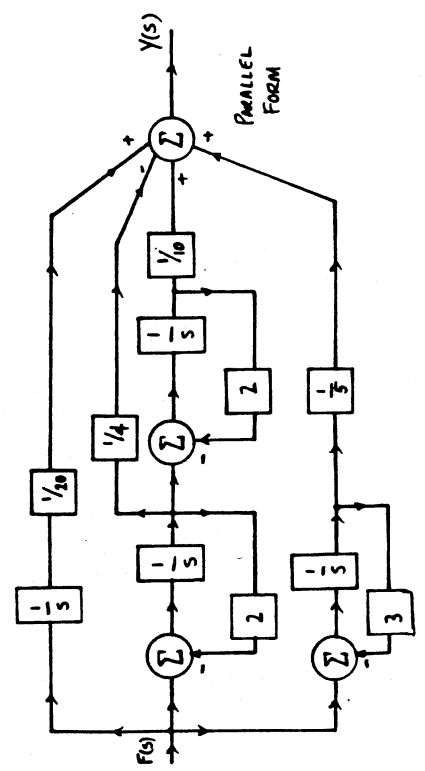
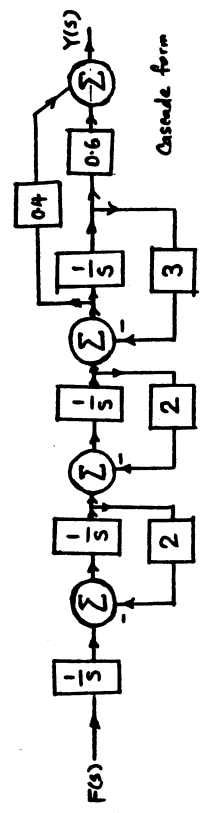
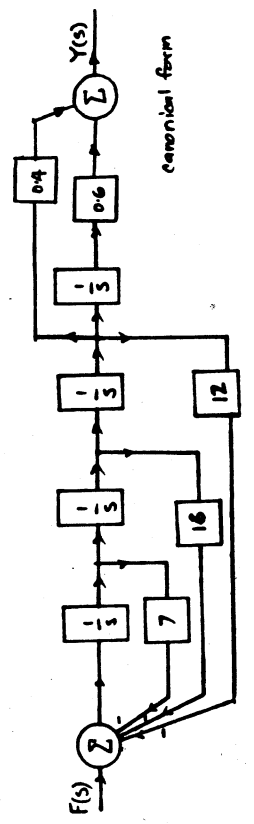

Fig. S6.6-3

Fig. S6.6-3 and S6.6-4

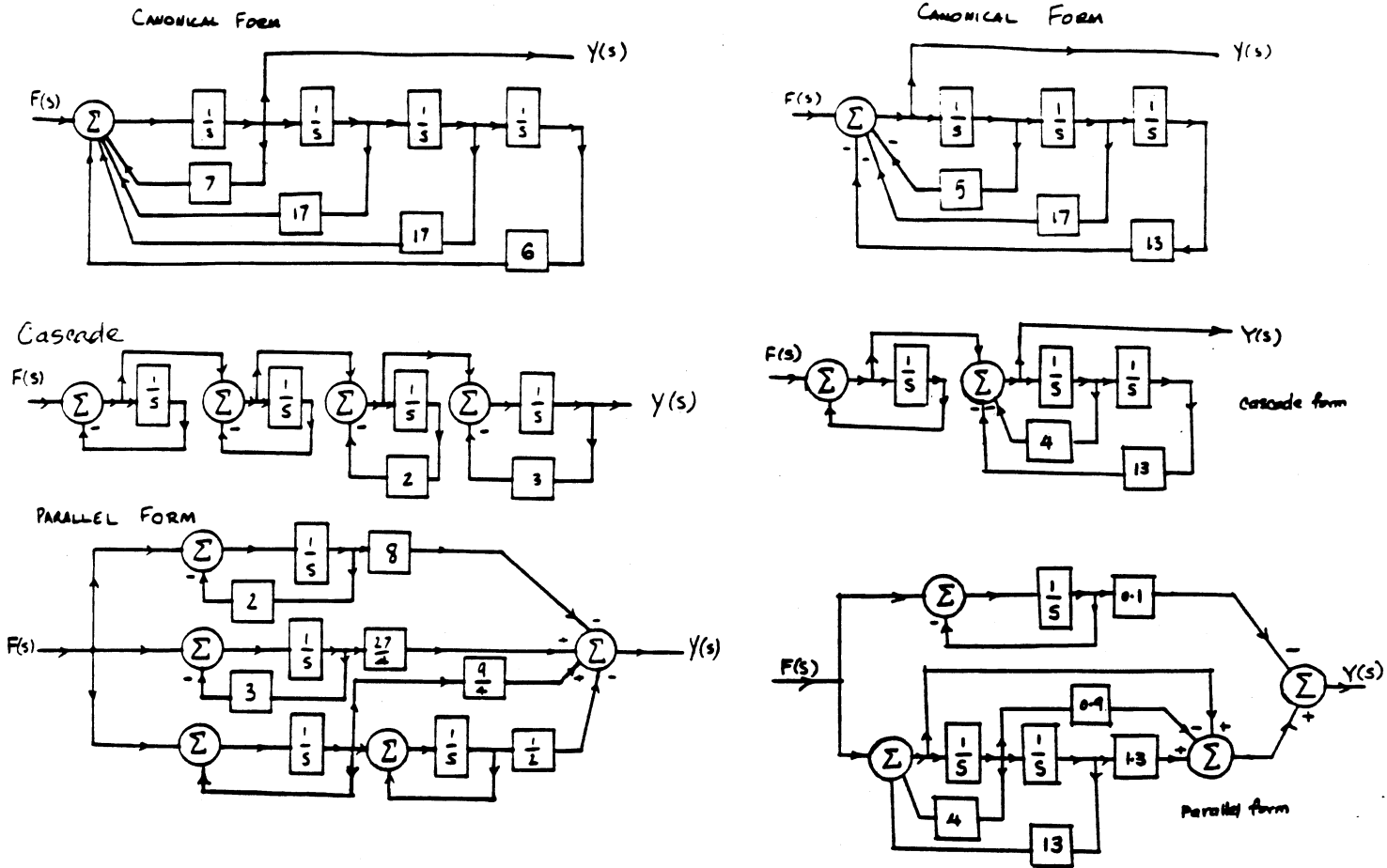

Fig. S6.6-5 and S6.6-6

For the canonical form, we have  $a_0 = 2, a_1 = 4, a_2 = 3,$  and  $b_0 = 0, b_1 = 6, b_2 = 3.$  Figure S6.6-2a shows a canonical, cascade and parallel realizations. Note that the roots of  $s^2 + 2s + 2$  are complex. therefore, the quadratic term must be realized directly.

(b)

$$\begin{aligned}
 H(s) &= \frac{2s - 4}{(s + 2)(s^2 + 4)} = \frac{2s - 4}{s^3 + 2s^2 + 4s + 8} \\
 &= \frac{2(s - 2)}{s^3 + 2s^2 + 4s + 8} = \left(\frac{s - 2}{s + 2}\right) \left(\frac{2}{s^2 + 4}\right) = -\frac{1}{s + 2} + \frac{s}{s^2 + 4}
 \end{aligned}$$

For a canonical forms, we have  $a_0 = 8, a_1 = 4, a_2 = 2,$  and  $b_0 = -4, b_1 = 2, b_2 = 0, b_3 = 0.$  Figure S6.6-2b shows a canonical, cascade and parallel realizations.

6.6-3

$$\begin{aligned}
 H(s) &= \frac{2s + 3}{5(s^4 + 7s^3 + 16s^2 + 12s)} = \frac{0.4s + 0.6}{s^4 + 7s^3 + 16s^2 + 12s} \\
 &= \left(\frac{1}{s}\right) \left(\frac{1}{s + 2}\right) \left(\frac{1}{s + 2}\right) \left(\frac{0.4s + 0.6}{s + 3}\right) = \frac{1}{20s} - \frac{1}{4(s + 2)} + \frac{1}{10(s + 2)^2} + \frac{1}{5(s + 3)}
 \end{aligned}$$

Figure S6.6-3 shows a canonical, cascade and parallel realizations.

6.6-4

$$H(s) = \frac{s(s + 1)(s + 2)}{(s + 5)(s + 6)(s + 8)} = \frac{s^3 + 3s^2 + 2s}{s^3 + 19s^2 + 118s + 240} = 1 - \frac{20}{s + 5} + \frac{60}{s + 6} - \frac{56}{s + 8}$$

For a canonical form  $a_0 = 24, a_1 = 118, a_2 = 19,$  and  $b_0 = 0, b_1 = 2, b_2 = 3, b_3 = 1.$  Figure S6.6-4 shows a canonical, cascade and parallel realizations.



## 6.6-5

$$\begin{aligned}
 H(s) &= \frac{s^3}{(s+1)^2(s+2)(s+3)} = \frac{s^3}{s^4 + 7s^3 + 17s^2 + 17s + 6} \\
 &= \left(\frac{s}{s+1}\right) \left(\frac{s}{s+1}\right) \left(\frac{s}{s+2}\right) \left(\frac{1}{s+3}\right) = -\frac{8}{s+2} + \frac{27}{s+3} + \frac{9}{s+1} - \frac{1}{(s+1)^2}
 \end{aligned}$$

Figure S6.6-5 shows a canonical, cascade and parallel realizations.

## 6.6-6

$$\begin{aligned}
 H(s) &= \frac{s^3}{(s+1)(s^2+4s+13)} = \frac{s^3}{s^3 + 5s^2 + 17s + 13} \\
 &= \left(\frac{s}{s+1}\right) \left(\frac{s^2}{s^2+4s+13}\right) = -\frac{0.1}{s+1} + \frac{s^2 - 0.9s + 1.3}{s^2 + 4s + 13} = 1 - \frac{0.1}{s+1} - \frac{4.9s + 11.7}{s^2 + 4s + 13}
 \end{aligned}$$

Figure S6.6-6 shows a canonical, cascade and parallel realizations.

6.6-7 Application of eq. (6.69) to Fig. P6.6-7a yields

$$H_1(s) = \frac{\frac{1}{(s+a)^2}}{1 + \frac{b^2}{(s+a)^2}} = \frac{1}{(s+a)^2 + b^2}$$

Figure P6.6-7b is a feedback system with forward gain  $G(s) = \frac{1}{s+a}$  and the loop gain  $\frac{b^2}{(s+a)^2}$ . Therefore

$$H_2(s) = \frac{\frac{1}{s+a}}{1 + \frac{b^2}{(s+a)^2}} = \frac{s+a}{(s+a)^2 + b^2}$$

The output in Fig. P6.6-7c is the same of  $B - aA$  times the output of Fig. P6.6-7a and  $A$  times the output of Fig. P6.6-7b. Therefore its transfer function is

$$\begin{aligned}
 H(s) &= (B - aA)H_1(s) + AH_2(s) \\
 &= \frac{B - aA}{(s+a)^2 + b^2} + \frac{A(s+a)}{(s+a)^2 + b^2} \\
 &= \frac{As + B}{(s+a)^2 + b^2}
 \end{aligned}$$

6.6-8 These transfer functions are readily realized by using the arrangement in Fig. 6.30 by a proper choice of  $Z_f(s)$  and  $Z(s)$ .

(i) In Fig. S6.6-8a

$$\begin{aligned}
 Z_f(s) &= \frac{\frac{R_f}{C_f s}}{R_f + \frac{1}{C_f s}} = \frac{1}{C_f(s+a)} \quad a = \frac{1}{R_f C_f} \\
 Z(s) &= R
 \end{aligned}$$

and

$$H(s) = -\frac{Z_f(s)}{Z(s)} = -\frac{k}{s+a} \quad k = \frac{1}{RC_f}, \quad a = \frac{1}{R_f C_f}$$

Choose  $R = 10,000$ ,  $R_f = 20,000$  and  $C_f = 10^{-5}$ . This yields  $k = 10$  and  $a = 5$ . Therefore

$$H(s) = \frac{-10}{s+5}$$

(ii) This is same as (i) followed by an amplifier of gain  $-1$  as shown in Fig. S6.6-8b.

(iii) For the first stage in Fig. S6.6-8c (see Exercise E6.11, Fig. 6.34b),

$$\begin{aligned}
 Z_f(s) &= \frac{1}{C_f(s+a)} \quad a = \frac{1}{R_f C_f} \\
 Z(s) &= \frac{1}{C(s+b)} \quad b = \frac{1}{RC}
 \end{aligned}$$

and

$$H(s) = -\frac{Z_f(s)}{Z(s)} = -\frac{C}{C_f} \left( \frac{s+b}{s+a} \right)$$

Choose  $C = C_f = 10^{-4}$ ,  $R = 5000$ ,  $R_f = 2000$ . This yields

$$H(s) = -\left( \frac{s+2}{s+5} \right)$$

This is followed by an op amp of gain  $-1$  as shown in Fig. S6.6-8c. This yields

$$H(s) = \frac{s+2}{s+5}$$

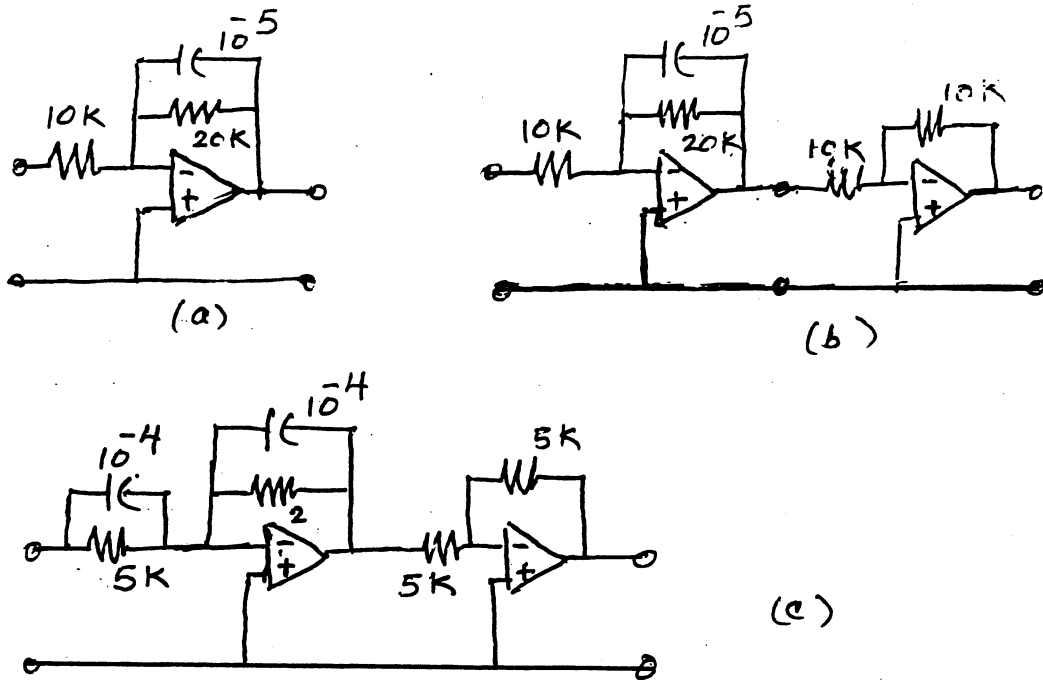

Fig. S6.6-8

6.6-9 One realization is given in Fig. S6.6-8c. For the other realization, we express  $H(s)$  as

$$H(s) = \frac{s+2}{s+5} = 1 - \frac{3}{s+5}$$

We realize  $H(s)$  as a parallel combination of  $H_1(s) = 1$  and  $H_2(s) = -3/(s+5)$  as shown in Fig. S6.6-9. The second stage serves as a summer for which the inputs are the input and output of the first stage. Because the summer has a gain  $-1$ , we need a third stage of gain  $-1$  to obtain the desired transfer functions.

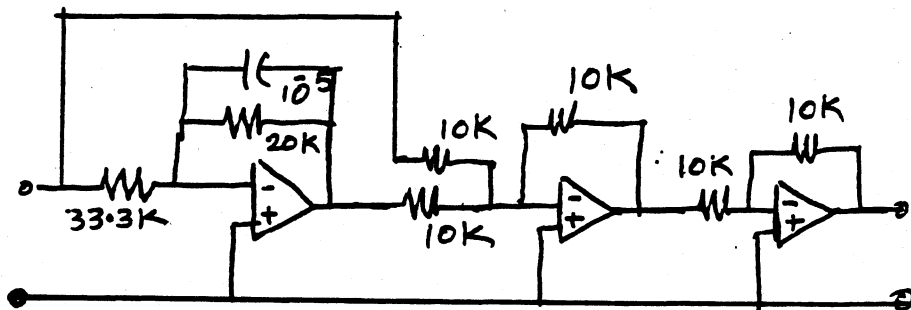
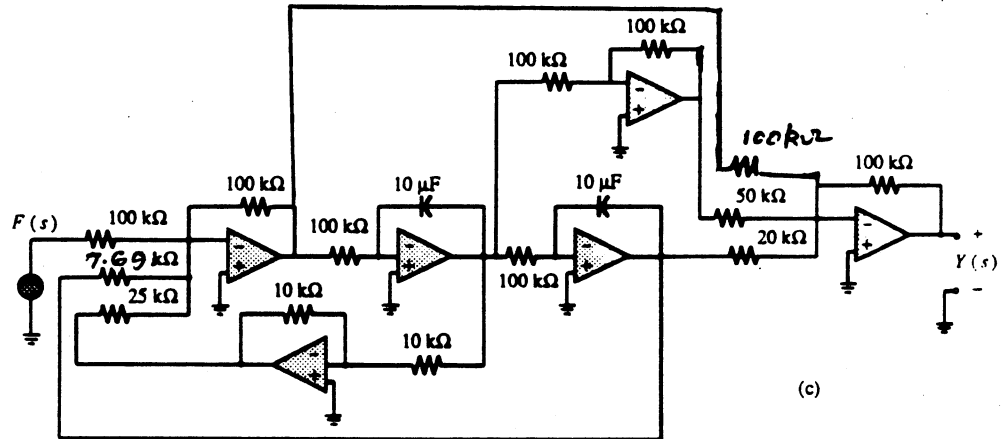
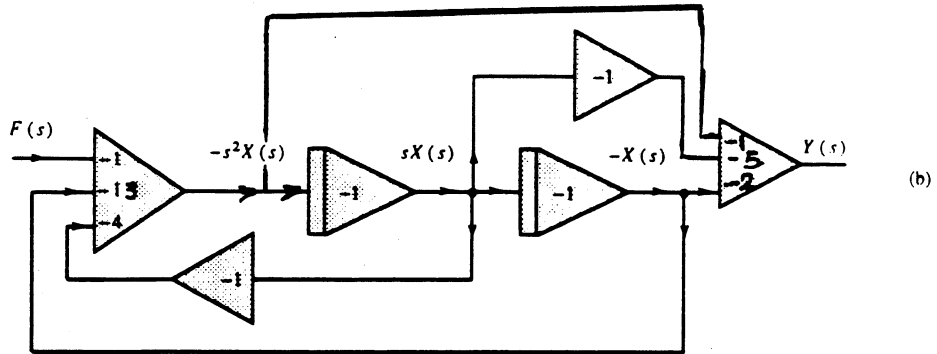
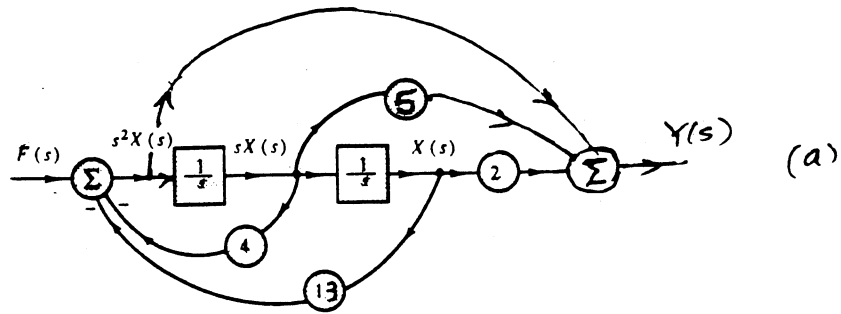

Fig. S6.6-9



FFig. S6.6-11

6.6-10 The transfer function here is identical to  $H(s)$  in Example 6.20 with a minor difference. Hence the op amp circuit in Fig. 6.32c can be used for our purpose with appropriate changes in the element values. The last summer input resistors now are  $\frac{100}{3} \text{ k}\Omega$  and  $\frac{100}{7} \text{ k}\Omega$  instead of  $50 \text{ k}\Omega$  and  $20 \text{ k}\Omega$ .

6.6-11 We follow the procedure in Example 6.20 with appropriate modifications. In this case  $a_0 = 13$ ,  $a_1 = 4$ , and  $b_0 = 2$ ,  $b_1 = 5$ , and  $b_2 = 1$  (in Example 6.20, we have  $a_0 = 10$ ,  $a_1 = 4$ , and  $b_0 = 5$ ,  $b_1 = 2$ , and  $b_2 = 0$ ). Because  $b_2$  is nonzero here, we have one more feedforward connection. Figure S6.6-11 shows the development of the suitable realization.

6.7-1

$$(a) \quad T(s) = \frac{9}{s^2 + 3s + 9} \Rightarrow \omega_n = 3, \quad 2\zeta\omega_n = 3 \Rightarrow \zeta = 0.5$$

Hence from Fig. 6.39,  $\text{PO} \approx 17\%$  and  $\omega_n t_r \approx 1.63$  which yields  $t_r = 0.526$ . Also

$$t_s = \frac{4}{\zeta\omega_n} = 4/1.5 = 2.67 \quad e_s = \lim_{s \rightarrow 0} [1 - T(s)] = 0 \quad e_r = \lim_{s \rightarrow 0} [1 - T(s)]/s = \frac{1}{3} \quad e_p = \lim_{s \rightarrow 0} [1 - T(s)]/s^2 = \infty$$

$$(b) \quad T(s) = \frac{4}{s^2 + 3s + 4} \Rightarrow \omega_n = 2, \quad 2\zeta\omega_n = 3 \Rightarrow \zeta = 0.75$$

Hence from Fig. 6.39,  $PO \approx 3\%$  and  $\omega_n t_r \approx 2.3$  which yields  $t_r = 1.15$ . Also

$$t_s = \frac{4}{\zeta\omega_n} = 4/1.5 = 2.67 \quad e_s = \lim_{s \rightarrow 0} [1 - T(s)] = 0 \quad e_r = \lim_{s \rightarrow 0} [1 - T(s)]/s = 0.75 \quad e_p = \lim_{s \rightarrow 0} [1 - T(s)]/s^2 = \infty$$

$$(c) \quad T(s) = \frac{95}{s^2 + 10s + 100} \Rightarrow \omega_n = 10, \quad 2\zeta\omega_n = 10 \Rightarrow \zeta = 0.5$$

Hence from Fig. 6.39,  $PO \approx 17\%$  and  $\omega_n t_r \approx 1.63$  which yields  $t_r = 0.163$ . Also

$$t_s = \frac{4}{\zeta\omega_n} = 4/5 = 0.8 \quad e_s = \lim_{s \rightarrow 0} [1 - T(s)] = 0.05 \quad e_r = \lim_{s \rightarrow 0} [1 - T(s)]/s = \infty \quad e_p = \lim_{s \rightarrow 0} [1 - T(s)]/s^2 = \infty$$

### 6.7-2

$$T(s) = K_1 \left[ \frac{\frac{K_2}{s(s+a)}}{1 + \frac{K_2}{s(s+a)}} \right] = \frac{K_1 K_2}{s^2 + as + K_2}$$

$PO = e^{-\zeta\pi/\sqrt{1-\zeta^2}} = 0.09 \Rightarrow \zeta = 0.608$ . Moreover,

$$t_p = \frac{\pi}{\omega_n \sqrt{1-\zeta^2}} = \frac{\pi}{4} \Rightarrow \omega_n \sqrt{1-\zeta^2} \Rightarrow \omega_n = 5.04 \text{ for } \zeta = 0.608$$

Thus

$$s^2 + 2\zeta\omega_n s + \omega_n^2 = s^2 + as + K_2 \Rightarrow a = 6.128, \text{ and } K_2 = 25.4$$

The steady-state value of the output is given to be 2. But, the steady-state value of the output is

$$y_{ss} = \lim_{s \rightarrow 0} \frac{K_a K_2}{s^2 + as + K_2} = K_1 = 2$$

Thus, the parameters are  $K_1 = 2$ ,  $K_2 = 25.4$  and  $a = 6.128$ .

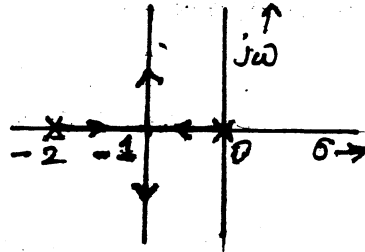

Figure S6.7-3

**6.7-3** The transfer function of the inner loop is  $1/(s+2)$ . Hence, the open loop transfer function of this unity feedback system is

$$G(s) = \frac{K}{s(s+2)} \quad T(s) = \frac{\frac{K}{s(s+2)}}{1 + \frac{K}{s(s+2)}} = \frac{K}{s^2 + 2s + K}$$

The characteristic roots are  $-1 \pm j\sqrt{K^2 - 1}$ . The root locus is shown in Fig. S6.7-3.

Observe that for the characteristic polynomial  $s^2 + 2s + K$ ,  $\zeta\omega_n = 1$  and  $\omega_n^2 = K$ . But,  $t_s = 4/\zeta\omega_n = 4$ . Hence, we cannot meet the settling time specification ( $t_s \leq 1$ ), regardless of the value of  $K$ . We now find the steady-state errors. This being a unity feedback system, we could use parameters  $K_p$ ,  $K_v$  and  $K_a$ . We have

$$K_p = \lim_{s \rightarrow 0} G(s) = \infty \quad K_v = \lim_{s \rightarrow 0} [sG(s)] = \frac{K}{2} \quad K_a = \lim_{s \rightarrow 0} [s^2 G(s)] = 0$$

Hence,

$$e_s = \frac{1}{1 + K_p} = 0 \quad e_r = \frac{1}{K_v} = \frac{2}{K} \quad e_p = \frac{1}{K_a} = \infty$$

We already observed that we cannot meet  $t_s$  specification. We can satisfy  $e_s$ . From Fig. 6.40, we conclude that we cannot meet both  $t_r \leq 0.3$  and  $PO \leq 30\%$ . We can meet one or the other, but not both.

- 6.7-4** (a) The open loop poles are at 0, -3 and -5. Hence, there are three root loci starting at 0, -3 and -5 (when  $K = 0$ ). Moreover, the segments 0 to -1 and -3 to -5 of the real axis are a part of the root locus. There is only one open loop zero at -1. Hence, one locus will terminate at -1 (when  $K = \infty$ ). The other two branches terminate at  $\infty$  (when  $K = \infty$ ) along asymptotes at angles  $k\pi/(n-m) = \pi/2$  and  $3\pi/2$ . The centroid of the asymptotes is  $\sigma = (0 - 3 - 5 + 1)/2 = -3.5$ . The root locus is shown in Fig. S6.7-4a.
- (b) The open loop poles are at 0, -3, -5 and -7. Hence, there are four root loci starting at 0, -3, -5 and -7 (when  $K = 0$ ). Moreover, the entire real axis in the LHP, except two segments 0 to -3 and -5 to -7 are a part of the root locus. There is only one open loop zero at -1. Hence, one locus will terminate at -1 (when  $K = \infty$ ). The other three branches terminate at  $\infty$  (when  $K = \infty$ ) along asymptotes at angles  $k\pi/(n-m) = \pi/3$  and  $\pi$  and  $5\pi/3$ . The centroid of the asymptotes is  $\sigma = (0 - 3 - 5 - 7 + 1)/3 = -4.67$ . The root locus is shown in Fig. S6.7-4b.
- (c) The open loop poles are at 0 -3. Hence, there are two root loci starting at 0 and -3 (when  $K = 0$ ). Moreover, the entire real axis in the LHP, except the segment from -3 to -5 is a part of the root locus. There is only one open loop zero at -5. Hence, one locus will terminate at -5 (when  $K = \infty$ ). The other branch terminate at  $\infty$  (when  $K = \infty$ ) along asymptote at angles  $k\pi/(n-m) = \pi$ . The root locus is shown in Fig. S6.7-4c.
- (d) The open loop poles are at 0, -4 and  $-1 \pm j$ . Hence, there are four root loci starting at 0, -4 and  $-1 \pm j$  (when  $K = 0$ ). Moreover, the entire real axis, except the segment from -1 to -4 is a part of the root locus. There is only one open loop zero at -1. Hence, one locus will terminate at -1 (when  $K = \infty$ ). The other three branches terminate at  $\infty$  (when  $K = \infty$ ) along asymptotes at angles  $k\pi/(n-m) = \pi/3, \pi$  and  $5\pi/3$ . The centroid of the asymptotes is  $\sigma = (0 - 4 - 1 - 1 + 1)/3 = -1.67$ . The root locus is shown in Fig. S6.7-4d.

- 6.7-5** First, we draw the root locus for the system. The open loop poles are at 0 and -10. Hence, there are two root loci starting at 0 and -10 (when  $K = 0$ ). Moreover, this segment from 0 to -10 of the real axis is a part of the root locus. There are no open loop zeros. Hence, both loci terminate at  $\infty$  (for  $K = \infty$ ) along asymptotes at angles  $k\pi/(n-m) = \pi/2$  and  $3\pi/2$ . The centroid of the asymptotes is  $\sigma = (0 - 10)/2 = -5$ . The root locus is shown in Fig. S6.7-5a.

We now superimpose Fig. 6.40 on the root locus, and demarcate the region for  $PO \leq 16\%$ ,  $t_r \leq 0.2$  and  $t_s \leq 0.5$ . We find that we can meet PO and  $t_r$  specifications, but not  $t_s$  because for  $t_s \leq 0.5$ , the roots must be to the left of -8. In our case, both the roots are always to the right of -5 for all  $K$ . Hence, we cannot satisfy  $t_s$  condition for any value of  $K$ .

We also need  $e_s = 0$  and  $e_r \leq 0.06$ . This is a unity feedback system with  $G(s) = K/s(s+10)$ . Hence,  $K_p = \infty$  and  $K_v = K/10$ . Also  $e_s = 1/(1+K_p) = 0$  and  $e_r = 1/K_v = 10/K$ . Thus, we can satisfy both the steady-state specifications by choosing  $K \geq 600$ . But, as we saw, we cannot satisfy  $t_s$  requirement for any value of  $K$ .

To obtain  $t_s \leq 0.5$ , the root locus must be to the left of -8, whereas our root locus is to the left of -5. Hence, to meet the  $t_s$  requirement, we must shift the locus to the left by using compensation. An easy solution would be to cancel the pole at -10 and place another pole at somewhere to the left of -16. Let us select the new pole at -20. This is clearly a lead compensator with transfer function

$$G_c(s) = \frac{s+10}{s+20}$$

The new open loop transfer function is  $G(s) = K/s(s+20)$ , and the centroid of the corresponding root locus is at -10 as shown in Fig. S6.7-5b. We superimpose this root locus on Fig. 6.40 and observe that all the specifications can be oversatisfied as long as  $K$  is large enough so that the roots are not on the real axis. This can be readily obtained from a computer generated root locus, or we can compute it as follow. The closed-loop transfer function is

$$T(s) = \frac{\frac{K}{s(s+20)}}{1 + \frac{K}{s(s+20)}} = \frac{K}{s^2 + 20s + K}$$

The characteristic polynomial is  $s^2 + 20s + K$ . The characteristic roots [poles of  $T(s)$ ] are  $-10 \pm j\sqrt{K-100}$ . This shows that the plot emerges from real axis at  $K = 100$ . Hence, we should choose  $K > 100$ . To find the exact value, we shall consider the steady-state errors. In this case,  $K_p = \infty$ , and  $K_v = K/20$ . Hence,  $e_s = 0$  and  $e_r = 20/K \leq 0.06$ . This yields  $K \geq 333.34$ . Let us now verify the transient parameters. The roots are  $-10 \pm j\sqrt{333.34 - 100} = -10 \pm j15.27$ . For these pole values, it is clear from Fig. 6.40 that all the parameters PO,  $t_s$  and  $t_r$  are within specifications.

Alternately, we can compute all the transient parameters as follows. The characteristic polynomial is  $s^2 + 20s + K = s^2 + 2\zeta\omega_n s + \omega_n^2$ . Hence,  $\omega_n = \sqrt{K}$ , and  $\zeta\omega_n = 10$ . Thus,  $\sqrt{K}\zeta = 10$  and  $\zeta = 10/\sqrt{K}$ . Now

$$PO = e^{-\zeta\pi/\sqrt{1-\zeta^2}} = 0.16 \Rightarrow \zeta = 0.504$$

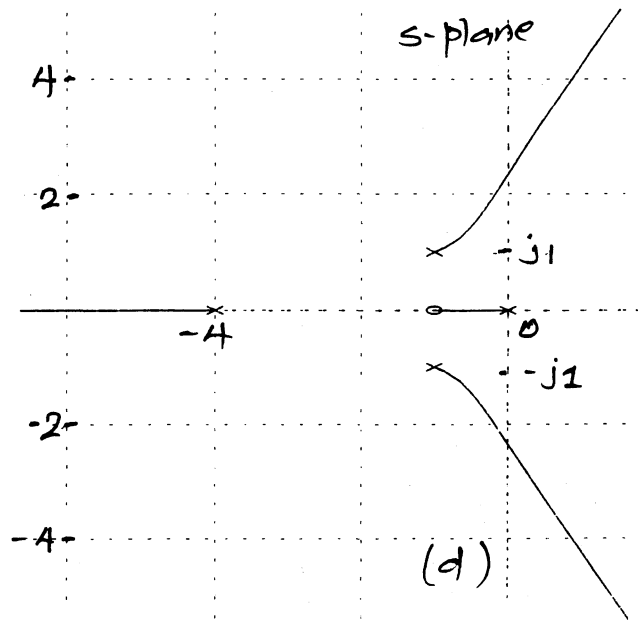
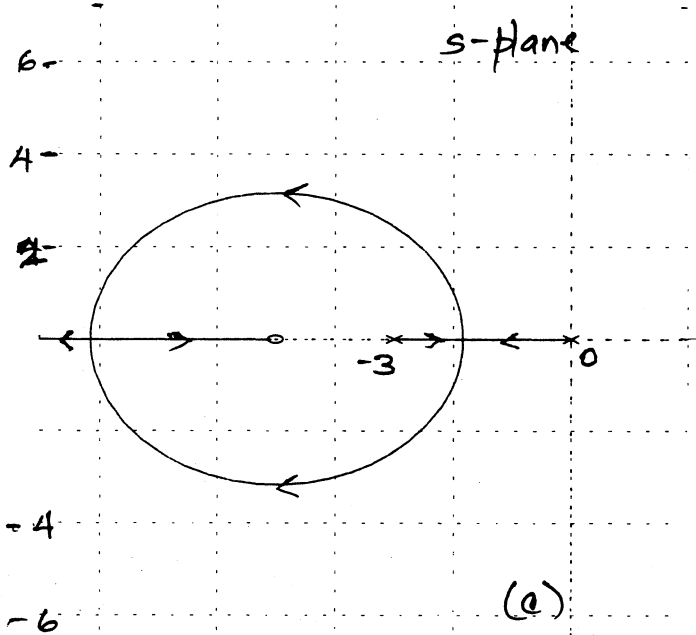
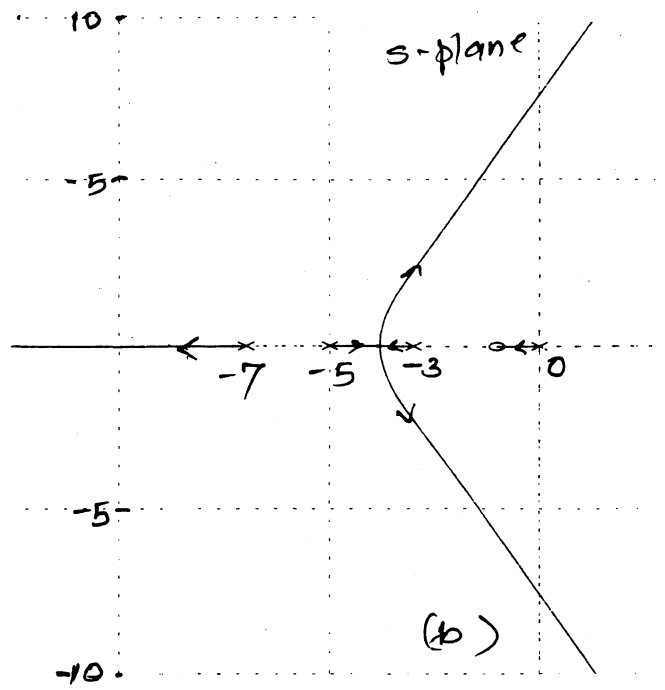
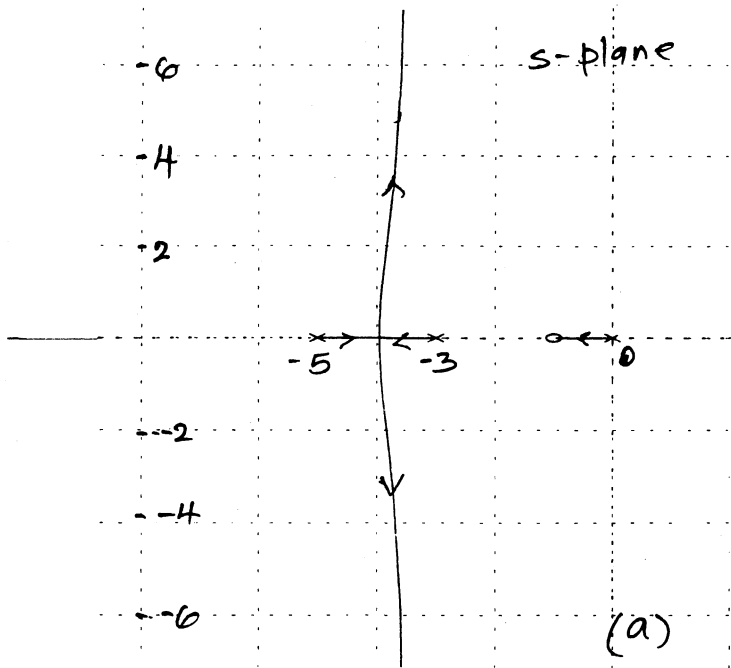

Fig. S6.7-4

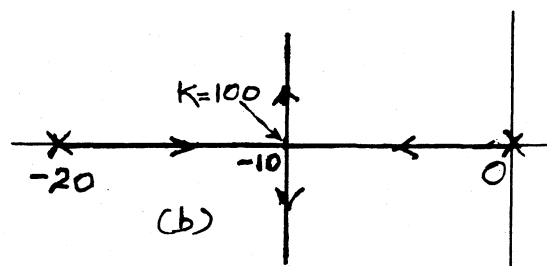
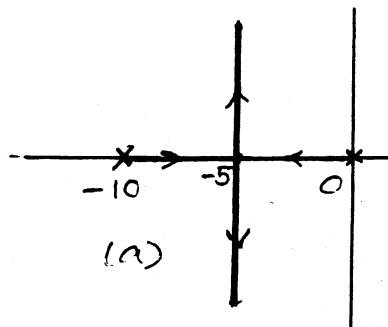

Figure S6.7-5

Also

$$\sqrt{K}\zeta = 0.504\sqrt{K} = 10 \Rightarrow K = 393.67$$

Moreover,  $t_n = 4/\zeta\omega_n = 0.4$ . For  $K = 393.67$ , we meet all the transient specifications. Also  $e_s = 0$  and  $e_r = 20/K = 0.0508$ . Thus, we meet all the specifications for  $K = 393.67$ . Actually, any value of  $K$  in the range  $333.34 \leq K \leq 393.67$  will satisfy all the conditions.

**6.8-1 (a)** Let  $f_1(t) = f(t)u(t) = e^t u(t)$  and  $f_2(t) = f(t)u(-t) = u(-t)$ . Then  $F_1(s)$  has a region of convergence  $\sigma > 1$ . And  $F_2(s)$  has a region  $\sigma < 0$ . Hence there is no common region of convergence for  $F(s) = F_1(s) + F_2(s)$ .

(b)  $f_1(t) = e^{-t}u(t)$ , and  $F_1(s) = \frac{1}{s+1}$  converges for  $\sigma > -1$ . Also  $f_2(t) = u(-t)$ , and  $F_2(s) = -\frac{1}{s}$  converges for  $\sigma < 0$ . Therefore, the strip of convergence is

$$-1 < \sigma < 0$$

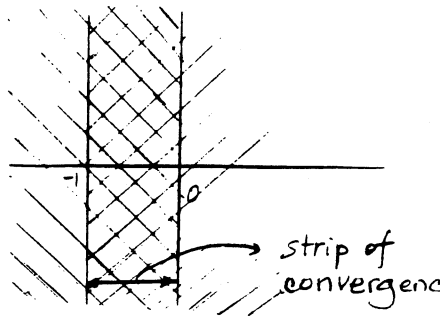

Figure S6.8-1b

(c)

$$\left. \begin{aligned} \frac{1}{t^2+1} e^{-st} \rightarrow 0 \end{aligned} \right\} \begin{aligned} &\text{as } t \rightarrow \infty \text{ if } \operatorname{Re} s \geq 0 \\ &\text{as } t \rightarrow -\infty \text{ if } \operatorname{Re} s \leq 0 \end{aligned}$$

Hence the convergence occurs at  $\sigma = 0$  ( $j\omega$ -axis)

(d)

$$f(t) = \frac{1}{1+e^t}$$

$$\left. \begin{aligned} \frac{1}{1+e^t} e^{-st} \rightarrow 0 \end{aligned} \right\} \begin{aligned} &\text{as } t \rightarrow \infty \text{ if } \operatorname{Re} s > -1 \\ &\text{as } t \rightarrow -\infty \text{ if } \operatorname{Re} s < 0 \end{aligned}$$

Hence the region of convergence is  $-1 < \sigma < 0$

(e)

$$f(t) = e^{-kt^2}$$

$$\left. \begin{aligned} e^{-kt^2} e^{-st} \rightarrow 0 \end{aligned} \right\} \begin{aligned} &\text{as } t \rightarrow \infty \text{ for any value of } s \\ &\text{as } t \rightarrow -\infty \text{ for any value of } s \end{aligned}$$

Hence the region of convergence is the entire  $s$ -plane.

**6.8-2 (a)**

$$f(t) = e^{-|t|} = e^{-t}u(t) + e^t u(-t) = f_1(t) + f_2(t)$$

$$F_1(s) = \frac{1}{s+1} \quad \sigma > -1$$

$$f_2(-t) = e^{-t}u(t) \quad \text{and} \quad F_2(-s) = \frac{1}{s+1}$$

$$\text{and} \quad F_2(s) = \frac{1}{-s+1} \quad \sigma < 1$$

$$\text{Hence: } F(s) = F_1(s) + F_2(s) = \frac{1}{s+1} + \frac{1}{-s+1} = \frac{-2}{s^2-1} \quad -1 < \sigma < 1$$

(b)

$$f(t) = e^{-|t|} \cos t = e^{-t} \cos t u(t) + e^t \cos t u(-t) = f_1(t) + f_2(t)$$

$$\text{Hence } F_1(s) = \frac{s+1}{(s+1)^2+1} \quad \text{and} \quad F_2(-s) = \frac{s+1}{(s+1)^2+1} \quad \sigma < 1$$

$$F(s) = F_1(s) + F_2(s) = \frac{s+1}{(s+1)^2+1} - \frac{s-1}{(s-1)^2+1} = \frac{4-2s^2}{s^4-4} \quad -1 < \sigma < 1$$

(c)

$$f(t) = e^t u(t) + e^{2t} u(-t); \quad F_1(s) = \frac{1}{s-1} \quad \sigma > 1 \quad \text{and} \quad F_2(-s) = \frac{1}{s+2}$$

$$F_2(s) = \frac{1}{-s+2} \quad \sigma < 2.$$

$$\text{Hence } F(s) = F_1(s) + F_2(s) = \frac{-1}{(s-1)(s-2)} \quad 1 < \sigma < 2$$

(d)

$$f(t) = e^{-tu(t)} = \begin{cases} e^{-t} & \text{for } t > 0 \\ 1 & \text{for } t < 0 \end{cases}$$

$$f_1(t) = e^{-t} u(t), \quad f_2(t) = u(-t). \quad \text{Hence } F_1(s) = \frac{1}{s+1} \quad \sigma > -1$$

$$\text{and } F_2(-s) = \frac{1}{s}, \quad F_2(s) = \frac{-1}{s} \quad \sigma < 0$$

$$\text{and hence: } F(s) = \frac{1}{s+1} - \frac{1}{s} = \frac{-1}{s(s+1)} \quad -1 < \sigma < 0$$

(e)

$$f(t) = e^{tu(-t)} = \begin{cases} f_1(t) = 1 & \text{for } t > 0 \\ f_2(t) = e^t & \text{for } t < 0 \end{cases}$$

$$F_1(s) = \frac{1}{s} \quad \sigma > 0$$

$$F_2(-s) = \frac{1}{s+1} \quad F_2(s) = \frac{1}{-s+1} \quad \sigma < 1$$

$$\text{and hence: } F(s) = \frac{1}{s} - \frac{1}{s-1} = \frac{-1}{s(s-1)} \quad 0 < \sigma < 1$$

(f)

$$f(t) = \cos \omega_0 t u(t) + e^t u(-t) = f_1(t) + f_2(t)$$

$$F_1(s) = \frac{s}{s^2 + \omega_0^2} \quad \sigma > 0$$

$$\text{and } F_2(-s) = \frac{1}{s+1}, \quad F_2(s) = \frac{1}{1-s} \quad \sigma < 1$$

$$F(s) = F_1(s) + F_2(s) = \frac{-(s + \omega_0^2)}{(s-1)(s^2 + \omega_0^2)} \quad 0 < \sigma < 1$$

6.8-3 (a)

$$\begin{aligned} F(s) &= \frac{2s+5}{(s+2)(s+3)} \quad -3 < \sigma < -2 \\ &= \frac{1}{s+2} + \frac{1}{s+3} \quad -3 < \sigma < -2 \end{aligned}$$

The pole  $-2$  lies to the right, and the pole  $-3$  lies to the left of the region of convergence; hence the first term represents causal and the second term represents anticausal signal:

$$f(t) = e^{-3t} u(t) - e^{-2t} u(-t)$$



(b)

$$\begin{aligned} F(s) &= \frac{2s-5}{(s-2)(s-3)} & 2 < \sigma < 3 \\ &= \frac{1}{s-2} + \frac{1}{s-3} & 2 < \sigma < 3 \end{aligned}$$

The pole at  $-2$  lies to the left and that at  $3$  lies to the right of the region of convergence; hence

$$f(t) = e^{2t}u(t) - e^{3t}u(-t)$$

(c)

$$\begin{aligned} F(s) &= \frac{2s+3}{(s+1)(s+2)} & \sigma > -1 \\ &= \frac{1}{s+1} + \frac{1}{s+2} & \sigma > -1 \end{aligned}$$

Both poles lie to the left of the region of convergence, and

$$f(t) = (e^{-t} + e^{-2t})u(t)$$

(d)

$$\begin{aligned} F(s) &= \frac{2s+3}{(s+1)(s+2)} & \sigma < -2 \\ &= \frac{1}{s+1} + \frac{1}{s+2} & \sigma < -2 \end{aligned}$$

Both poles lie to the right of the region of convergence, and hence:

$$f(t) = -(e^{-t} + e^{-2t})u(-t)$$

(e)

$$\begin{aligned} F(s) &= \frac{3s^2 - 2s - 17}{(s+1)(s+3)(s-5)} & -1 < \sigma < 5 \\ &= \frac{1}{s+1} + \frac{1}{s+3} + \frac{1}{s-5} \end{aligned}$$

The poles  $-1$  and  $-3$  lie to the left of the region of convergence, whereas the pole  $5$  lies to the right:

$$f(t) = (e^{-t} + e^{-3t})u(t) - e^{5t}u(-t)$$

#### 6.8-4

$$\frac{2s^2 - 2s - 6}{(s+1)(s-1)(s+2)} = \frac{1}{s+1} - \frac{1}{s-1} + \frac{2}{s+2}$$

(a)  $\text{Re } s > 1$ : All poles to the left of the region of convergence. Therefore

$$f(t) = (e^{-t} - e^t + 2e^{-2t})u(t)$$

(b)  $\text{Re } s < -2$ : All poles to the right of the region of convergence. Therefore

$$f(t) = (-e^{-t} + e^t - 2e^{-2t})u(-t)$$

(c)  $-1 < \text{Re } s < 1$ : Poles  $-1$  and  $-2$  to the left and pole  $1$  to the right of the region of convergence. Therefore

$$f(t) = (e^{-t} + 2e^{-2t})u(t) + e^t u(-t)$$

(d)  $-2 < \text{Re } s < -1$ : Poles  $-1$  and  $1$  are to the right and pole  $-2$  is to the left of the region of convergence. Therefore

$$f(t) = 2e^{-2t}u(t) + [-e^{-t} + e^t]u(-t)$$

6.8-5 (a)

$$f(t) = e^{-\frac{|t|}{2}}, \quad H(s) = \frac{1}{s+1} \quad \sigma > -1$$

$$\text{And } F(s) = \frac{1}{s+0.5} - \frac{1}{s-0.5} \quad -\frac{1}{2} < \sigma < \frac{1}{2}$$

$$\text{hence: } Y(s) = H(s)F(s) = \frac{1}{s+1} \left[ \frac{1}{s+0.5} - \frac{1}{s-0.5} \right] \quad -\frac{1}{2} < \sigma < \frac{1}{2}$$

$$\begin{aligned} Y(s) &= \frac{-2}{s+1} + \frac{2}{s+0.5} + \frac{\frac{2}{3}}{s+1} - \frac{\frac{2}{3}}{s-0.5} \\ &= \frac{-\frac{4}{3}}{s+1} + \frac{2}{s+0.5} - \frac{\frac{2}{3}}{s-0.5} \quad -\frac{1}{2} < \sigma < \frac{1}{2} \end{aligned}$$

The poles  $-1$  and  $-0.5$ , which are to the left of the strip of convergence, yield the causal signal, and the pole  $0.5$ , which is to the right of the strip of convergence, yields the anticausal signal. Hence

$$y(t) = \left( -\frac{4}{3}e^{-t} + 2e^{-t/2} \right) u(t) + \frac{2}{3}e^{t/2}u(-t)$$

(b)

$$f(t) = e^t u(t) + e^{2t} u(-t)$$

$$\begin{aligned} F(s) &= \frac{1}{s-1} - \frac{1}{s-2} \quad 1 < \sigma < 2 \\ &= \frac{-1}{(s-1)(s-2)} \end{aligned}$$

$$\text{And } H(s) = \frac{1}{s+1} \quad \sigma > -1$$

$$\text{Hence: } Y(s) = H(s)F(s) = \frac{-1}{(s+1)(s-1)(s-2)} \quad 1 < \sigma < 2$$

$$Y(s) = \frac{-1/6}{s+1} + \frac{1/2}{s-1} - \frac{1/3}{s-2} \quad 1 < \sigma < 2$$

$$\text{Hence } y(t) = \left( -\frac{1}{6}e^{-t} + \frac{1}{2}e^t \right) u(t) + \frac{1}{3}e^{2t}u(-t)$$

(c)

$$f(t) = e^{-t/2}u(t) + e^{-t/4}u(-t)$$

$$F(s) = \frac{1}{s+0.5} - \frac{1}{s+0.25} = \frac{-\frac{1}{4}}{(s+0.5)(s+0.25)} \quad -\frac{1}{2} < \sigma < \frac{1}{4}$$

$$\text{Also } H(s) = \frac{1}{s+1} \quad \sigma > -1$$

$$\begin{aligned} \text{Hence: } Y(s) &= H(s)F(s) = \frac{-\frac{1}{4}}{(s+1)(s+0.5)(s+0.25)} \quad -\frac{1}{2} < \sigma < \frac{1}{4} \\ &= \frac{-\frac{2}{3}}{s+1} + \frac{2}{s+0.5} - \frac{\frac{4}{3}}{s+0.25} \quad -\frac{1}{2} < \sigma < \frac{1}{4} \end{aligned}$$

$$\text{and } y(t) = \left( -\frac{2}{3}e^{-t} + 2e^{-t/2} \right) u(t) + \frac{4}{3}e^{-t/4}u(-t)$$

(d)

$$f(t) = e^{2t}u(t) + e^t u(-t) = f_1(t) + f_2(t)$$

$$F_1(s) = \frac{1}{s-2} \quad \sigma > 2$$

$$F_2(s) = \frac{-1}{s-1} \quad \sigma < 1$$

\*

$$\text{and} \quad H(s) = \frac{1}{s+1} \quad \sigma > -1$$

In this case, there is no region of convergence that is common to  $F_1(s)$  and  $F_2(s)$ . However, each of  $F_1(s)$  and  $F_2(s)$  have a region of convergence that is common to  $H(s)$ . Hence the output can be computed by finding the system response to  $f_1(t)$  and  $f_2(t)$  separately, and then adding these two components. This means we need not worry about the common region of convergence for  $F_1(s)$  and  $F_2(s)$ . Thus:

$$Y(s) = Y_1(s) + Y_2(s) \quad \text{where}$$

$$\begin{aligned} Y_1(s) &= F_1(s)H(s) = \frac{1}{(s+1)(s-2)} \quad \sigma > 2 \\ &= \frac{-\frac{1}{3}}{s+1} + \frac{\frac{1}{3}}{s-2} \quad \sigma > 2 \end{aligned}$$

Observe that both the poles ( $-1$  and  $2$ ) are to the left of the region of convergence, hence both terms are causal, and:

$$y_1(t) = \left(-\frac{1}{3}e^{-t} + \frac{1}{3}e^{2t}\right) u(t)$$

$$\begin{aligned} Y_2(s) &= F_2(s)H(s) = \frac{-1}{(s+1)(s-1)} \quad -1 < \sigma < 1 \\ &= \frac{\frac{1}{2}}{s+1} - \frac{\frac{1}{2}}{s-1} \quad -1 < \sigma < 1 \end{aligned}$$

The poles  $-1$  and  $1$  are to the left and the right, respectively, of the strip of convergence. Hence the first term yields causal signal and the second yields anticausal signal. Hence

$$y_2(t) = -\frac{1}{2}e^{-t}u(t) + \frac{1}{2}e^t u(-t)$$

$$\text{Therefore} \quad y(t) = y_1(t) + y_2(t) = \left(\frac{1}{6}e^{-t} + \frac{1}{3}e^{2t}\right) u(t) + \frac{1}{2}e^t u(-t)$$

(e)

$$f(t) = e^{-\frac{t}{4}}u(t) + e^{-\frac{t}{2}}u(-t) = f_1(t) + f_2(t)$$

$$F(s) = F_1(s) + F_2(s)$$

$$\text{where} \quad F_1(s) = \frac{1}{s+0.25} \quad \sigma > -\frac{1}{4}$$

$$F_2(s) = \frac{-1}{s+0.5} \quad \sigma < -\frac{1}{2}$$

$$H(s) = \frac{1}{s+1} \quad \sigma > -1$$

Here also, we have no common region of convergence, for  $F_1(s)$  and  $F_2(s)$  as in part d. Let  $Y(s) = Y_1(s) + Y_2(s)$  where:

$$\begin{aligned} Y_1(s) &= \frac{1}{(s+1)(s+0.25)} \quad \sigma > -\frac{1}{4} \\ &= \frac{-\frac{4}{3}}{s+1} + \frac{\frac{4}{3}}{s+0.25} \quad \sigma > -\frac{1}{4} \end{aligned}$$

$$y_1(t) = \left( -\frac{4}{3}e^{-t} + \frac{4}{3}e^{-\frac{t}{4}} \right) u(t)$$

$$\begin{aligned} Y_2(s) &= \frac{-1}{(s+1)(s+0.5)} & -1 < \sigma < -\frac{1}{2} \\ &= \frac{2}{s+1} - \frac{2}{s+0.5} & -1 < \sigma < -\frac{1}{2} \end{aligned}$$

$$\text{and } y_2(t) = 2e^{-t}u(t) + 2e^{-\frac{t}{2}}u(-t)$$

$$\text{Hence } y(t) = y_1(t) + y_2(t) = \left( \frac{2}{3}e^{-t} + \frac{4}{3}e^{-\frac{t}{4}} \right) u(t) + 2e^{-\frac{t}{2}}u(-t)$$

(f)

$$f(t) = e^{-3t}u(t) + e^{-2t}u(-t) = f_1(t) + f_2(t)$$

$$F(s) = F_1(s) + F_2(s)$$

$$\text{where } F_1(s) = \frac{1}{s+3} \quad \sigma > -3$$

$$F_2(s) = \frac{-1}{s+2} \quad \sigma < -2$$

$$H(s) = \frac{1}{s+1} \quad \sigma > -1$$

In this case, there is a common region of convergence for  $F_1(s)$  and  $H(s)$ , but there is no region of convergence common to  $F_2(s)$  and  $H(s)$ . Hence the output  $y_1(t)$  will be finite but  $y_2(t)$  will be  $\infty$ .

# Chapter 7

---

7.1-1

$$H(j\omega) = \frac{j\omega + 2}{(j\omega)^2 + 5j\omega + 4} = \frac{j\omega + 2}{(4 - \omega^2) + j5\omega}$$

$$|H(j\omega)| = \sqrt{\frac{\omega^2 + 4}{(4 - \omega^2)^2 + (5\omega)^2}} = \sqrt{\frac{\omega^2 + 4}{\omega^4 + 17\omega^2 + 16}}$$

$$\angle H(j\omega) = \tan^{-1}\left(\frac{\omega}{2}\right) - \tan^{-1}\left(\frac{5\omega}{4 - \omega^2}\right)$$

(a)  $f(t) = 5 \cos(2t + 30^\circ)$ . Here  $\omega = 2$  and

$$|H(j2)| = \sqrt{\frac{2}{25}} = \frac{\sqrt{2}}{5}$$

$$\angle H(j\omega) = \tan^{-1} - \tan^{-1}(\infty) = 45^\circ - 90^\circ = -45^\circ$$

$$y(t) = 5 \frac{\sqrt{2}}{5} \cos(2t + 30^\circ - 45^\circ) = \sqrt{2} \cos(2t - 15^\circ)$$

(b)  $f(t) = 10 \sin(2t + 45^\circ)$

$$y(t) = 10 \left(\frac{\sqrt{2}}{5}\right) \sin(2t + 45^\circ - 45^\circ) = 2\sqrt{2} \sin 2t$$

(c)  $f(t) = 10 \cos(3t + 40^\circ)$ . Here  $\omega = 3$

$$|H(j\omega)| = \sqrt{\frac{13}{250}} = 0.228 \quad \text{and} \quad \angle H(j3) = 56.31^\circ - 108.43^\circ = -52.12^\circ$$

Therefore

$$y(t) = 10(0.228) \cos(3t + 40^\circ - 52.12^\circ) = 2.28 \cos(3t - 12.12^\circ)$$

7.1-2

$$H(j\omega) = \frac{j\omega + 3}{(j\omega + 2)^2}$$

$$|H(j\omega)| = \frac{\sqrt{\omega^2 + 9}}{\omega^2 + 4} \quad \text{and} \quad \angle H(j\omega) = \tan^{-1}\left(\frac{\omega}{3}\right) - \tan^{-1}\left(\frac{\omega}{2}\right)$$

(a)  $f(t) = 10u(t) = 10e^{j0t}u(t)$ . Here  $\omega = 0$  and  $H(j0) = 1$ . Therefore

$$y(t) = 1 \times 10e^{j0t}u(t) = 10u(t)$$

(b)  $f(t) = \cos(2t + 60^\circ)u(t)$ . Here  $\omega = 2$

$$|H(j2)| = \frac{\sqrt{13}}{8} \quad \text{and} \quad \angle H(j2) = 33.69^\circ - 90^\circ = -56.31^\circ$$

Therefore

$$y(t) = \frac{\sqrt{13}}{8} \cos(2t + 60^\circ - 56.31^\circ)u(t) = \frac{\sqrt{13}}{8} \cos(2t + 3.69^\circ)u(t)$$

(c)  $f(t) = \sin(3t - 45^\circ)u(t)$  Here  $\omega = 3$  and

$$|H(j3)| = \frac{\sqrt{18}}{13} \quad \text{and} \quad \angle H(j3) = 45^\circ - 112.62^\circ = -67.62^\circ$$

Therefore

$$y(t) = \frac{\sqrt{18}}{13} \sin(3t - 45^\circ - 67.62^\circ)u(t) = \frac{\sqrt{18}}{13} \sin(3t - 112.62^\circ)u(t)$$

(d)  $f(t) = e^{j3t}u(t)$

$$y(t) = H(j3)e^{j3t} = |H(j3)|e^{j[3t + \angle H(j3)]}u(t) = \frac{\sqrt{18}}{13} e^{j[3t - 67.62^\circ]}u(t)$$

## 7.1-3

$$H(j\omega) = \frac{-(j\omega - 10)}{j\omega + 10} = \frac{10 - j\omega}{10 + j\omega}$$

$$|H(j\omega)| = \sqrt{\frac{\omega^2 + 100}{\omega^2 + 100}} = 1$$

$$\angle H(j\omega) = \tan^{-1}\left(-\frac{\omega}{10}\right) - \tan^{-1}\left(\frac{\omega}{10}\right) = -2 \tan^{-1}\left(\frac{\omega}{10}\right)$$

(a)  $f(t) = e^{j\omega t}$

$$y(t) = H(j\omega)e^{j\omega t} = |H(j\omega)|e^{j[\omega t + \angle H(j\omega)]} = e^{j[\omega t - 2 \tan^{-1}(\omega/10)]}$$

(b)  $f(t) = \cos(\omega t + \theta)$

$$y(t) = \cos[\omega t + \theta - 2 \tan^{-1}(\frac{\omega}{10})]$$

(c)  $f(t) = \cos t$ . Here  $\omega = 1$

$$|H(j1)| = 1$$

$$\angle H(j\omega) = -2 \tan^{-1}\left(\frac{1}{10}\right) = -11.42^\circ$$

$$y(t) = \cos(t - 11.42^\circ)$$

(d)  $f(t) = \sin 2t$ . Here  $\omega = 2$

$$|H(j2)| = 1$$

$$\angle H(j2) = -2 \tan^{-1}\left(\frac{2}{10}\right) = -22.62^\circ$$

$$y(t) = \sin(2t - 22.62^\circ)$$

(e)  $f(t) = \cos 10t$ . Here  $\omega = 10$

$$|H(j10)| = 1$$

$$\angle H(j10) = -2 \tan^{-1}\left(\frac{10}{10}\right) = -90^\circ$$

$$y(t) = \cos(10t - 90^\circ) = \sin 10t$$

(f)  $f(t) = \cos 100t$ . Here  $\omega = 100$

$$|H(j100)| = 1$$

$$\angle H(j100) = -2 \tan^{-1}\left(\frac{100}{10}\right) = -168.58^\circ$$

$$y(t) = \cos(100t - 168.58^\circ)$$

7.2-1 (a) The transfer function can be expressed as

$$H(s) = \frac{100}{2 \times 20} \frac{s(\frac{s}{100} + 1)}{(\frac{s}{2} + 1)(\frac{s}{20} + 1)} = 2.5 \frac{s(\frac{s}{100} + 1)}{(\frac{s}{2} + 1)(\frac{s}{20} + 1)}$$

The amplitude response: The horizontal axis where the asymptotes begin is 2.5, which is 7.96 db. We draw the asymptotes at  $\omega = 1$  (20 dB/dec.), 2 (-20 dB/dec.), 20 (-20 dB/dec.), and 100 (20 dB/dec.) as shown in Fig. S7.2-1a. The corrections are applied at various points as discussed in Examples 7.3 and 7.4. to obtain the Bode plot for amplitude response. We follow the similar procedure for phase response.

(b) The transfer function can be expressed as

$$H(s) = \frac{10 \times 20}{100} \frac{(\frac{s}{10} + 1)(\frac{s}{20} + 1)}{s^2(\frac{s}{100} + 1)} = 2 \frac{(\frac{s}{10} + 1)(\frac{s}{20} + 1)}{s^2(\frac{s}{100} + 1)}$$

The amplitude response: The horizontal axis where the asymptotes begin is 2, which is 6 db. Asymptotes start at  $\omega = 1$  (-40 dB/dec.), 10 (20 dB/dec.), 20 (20 dB/dec.), and 100 (-20 dB/dec.). The corrections are applied at various points as discussed in Examples 7.3 and 7.4. to obtain the Bode plot.

(c) The transfer function can be expressed as

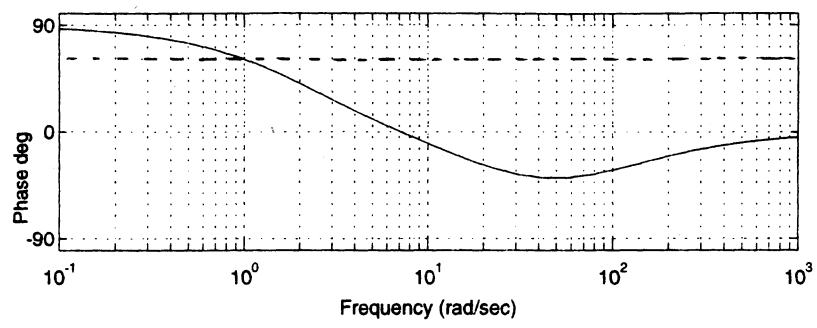
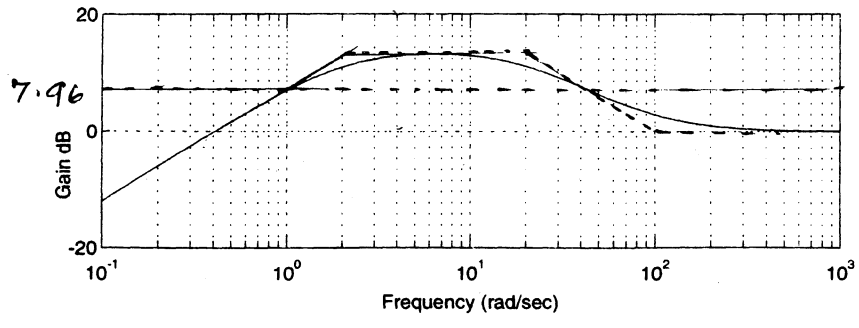

(a)

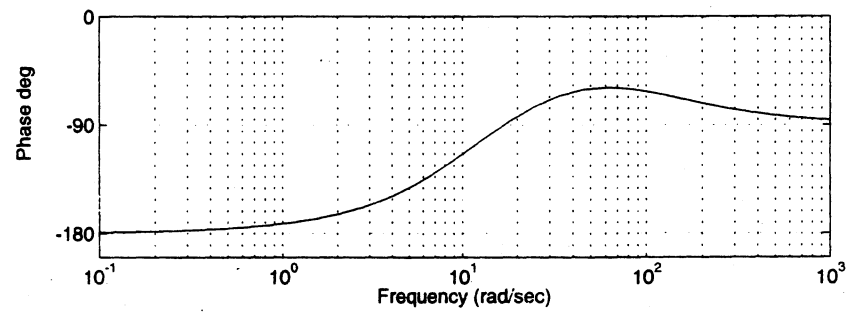
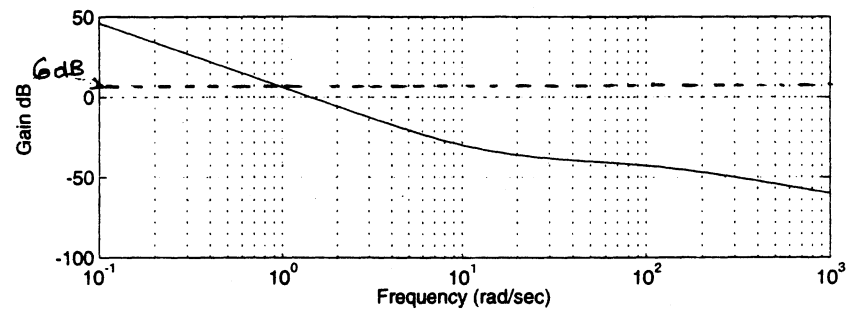

(b)

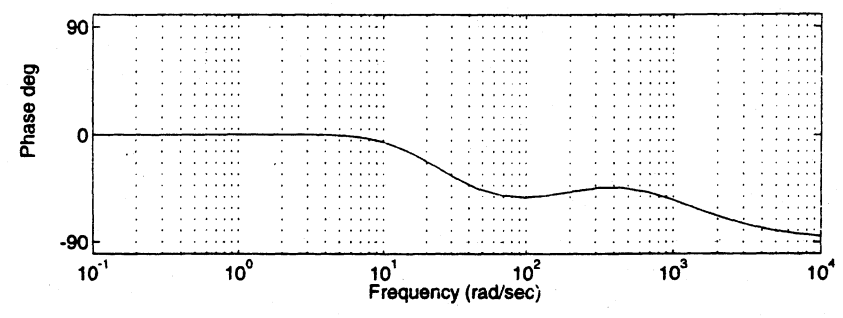
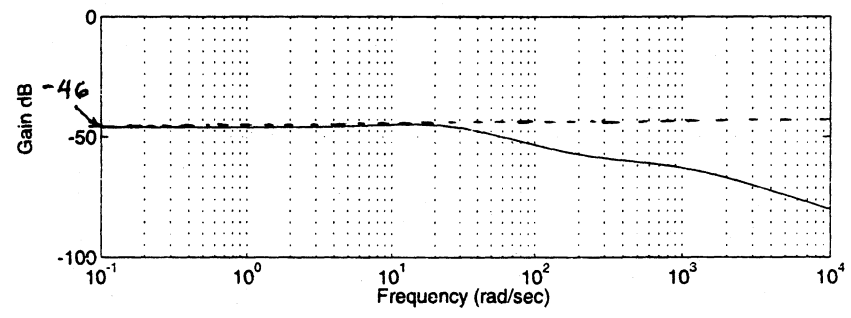

(c)

Fig. S 72-1

$$H(s) = \frac{10 \times 200}{400 \times 1000} \frac{(\frac{s}{10} + 1)(\frac{s}{200} + 1)}{(\frac{s}{20} + 1)^2(\frac{s}{1000} + 1)} = \frac{1}{200} \frac{(\frac{s}{10} + 1)(\frac{s}{200} + 1)}{(\frac{s}{20} + 1)^2(\frac{s}{1000} + 1)}$$

The amplitude response: The horizontal axis where the asymptotes begin is  $1/200$ , which is  $-46$  dB. Asymptotes start at  $\omega = 10$  (20 dB/dec.), 20 (-40 dB/dec.), 200 (20 dB/dec.), and 1000 (-20 dB/dec.). The corrections are applied at various points as discussed in Examples 7.3 and 7.4. to obtain the Bode plot.

**7.2-2 (a)** The transfer function can be expressed as

$$H(s) = \frac{1}{16} \frac{s^2}{(\frac{s}{1} + 1)(\frac{s^2}{16} + \frac{s}{4} + 1)}$$

The amplitude response: The horizontal axis where the asymptotes begin is  $1/16$ , which is  $-24$  dB. Asymptotes start at  $\omega = 1$  (40 dB/dec.), 1 (-20 dB/dec.), 4 (-40 dB/dec.). The corrections are applied at various points as discussed in Examples 7.3 and 7.4. to obtain the Bode plot.

**(b)** The transfer function can be expressed as

$$H(s) = \frac{1}{100} \frac{s}{(\frac{s}{1} + 1)(\frac{s^2}{100} + 0.1414s + 1)}$$

The amplitude response: The horizontal axis where the asymptotes begin is  $1/100$ , which is  $-40$  dB. Asymptotes start at  $\omega = 1$  (20 dB/dec.), 1 (-20 dB/dec.), 10 (-40 dB/dec.). The corrections are applied at various points as discussed in Examples 7.3 and 7.4. to obtain the Bode plot.

**(c)** The transfer function can be expressed as

$$H(s) = \frac{10}{100} \frac{\frac{s}{10} + 1}{s(\frac{s^2}{100} + 0.1414s + 1)}$$

The amplitude response: The horizontal axis where the asymptotes begin is  $1/10$ , which is  $-20$  dB. Asymptotes start at  $\omega = 1$  (-20 dB/dec.), 10 (20 dB/dec.), 10 (-40 dB/dec.). The corrections are applied at various points as discussed in Examples 7.3 and 7.4. to obtain the Bode plot.

**7.3-1 (a)** In this case,

$$H(j\omega) = \frac{\omega_c}{j\omega + \omega_c} \implies |H(j\omega)| = \frac{\omega_c}{\sqrt{\omega^2 + \omega_c^2}}$$

The dc gain is  $H(0) = 1$  and the gain at  $\omega = \omega_c$  is  $1/\sqrt{2}$ , which is  $-3$  dB below the dc gain. Hence, the 3-dB bandwidth is  $\omega_c$ . Also the dc gain is unity. Hence, the gain-bandwidth product is  $\omega_c$ .

We could derive this result indirectly as follows. The system is a lowpass filter with a single pole at  $\omega = \omega_c$ . The dc gain is  $H(0) = 1$  (0 dB). Because, there is a single pole at  $\omega_c$  (and no zeros), there is only one asymptote starting at  $\omega = \omega_c$  (at a rate  $-20$  dB/dec.). The break point is  $\omega_c$ , where there is a correction of  $-3$  dB. Hence, the amplitude response at  $\omega_c$  is 3 dB below 0 dB (the dc gain). Thus, the 3-dB bandwidth of this filter is  $\omega_c$ .

**(b)** The transfer function of this system is

$$H(s) = \frac{G(s)}{1 + G(s)H(s)} = \frac{\frac{\omega_c}{s + \omega_c}}{1 + \frac{9\omega_c}{s + \omega_c}} = \frac{\omega_c}{s + 10\omega_c}$$

We use the same argument as in part **(a)** to deduce that the dc gain is 0.1 and the 3-dB bandwidth is  $10\omega_c$ . Hence, the gain-bandwidth product is  $\omega_c$ .

**(c)** The transfer function of this system is

$$H(s) = \frac{G(s)}{1 - G(s)H(s)} = \frac{\frac{\omega_c}{s + \omega_c}}{1 - \frac{0.9\omega_c}{s + \omega_c}} = \frac{\omega_c}{s + 0.1\omega_c}$$

We use the same argument as in part **(a)** to deduce that the dc gain is 10 and the 3-dB bandwidth is  $0.1\omega_c$ . Hence, the gain-bandwidth product is  $\omega_c$ .

**7.4-1** We plot the poles  $-1 \pm j7$  and  $1 \pm j7$  in the  $s$ -plane. To find response at some frequency  $\omega$ , we connect all the poles and zeros to the point  $j\omega$  as shown in Fig. S7.4-1. Note that the product of distances from the zeros is equal to the product of the distances from the poles for all values of  $\omega$ . Therefore  $|H(j\omega)| = 1$ . Graphical argument shows that  $\angle H(j\omega)$  (sum of the angles from the zeros – sum of the angles from poles) starts at zero for  $\omega = 0$  and then reduces continuously (becomes negative) as  $\omega$  increases. As  $\omega \rightarrow \infty$ ,  $\angle H(j\omega) \rightarrow -2\pi$ .

**7.4-2 (a)** If  $r$  and  $d$  are the distances of the zero and pole, respectively from  $j\omega$ , then the amplitude response  $|H(j\omega)|$  is the ratio  $r/d$  corresponding to  $j\omega$ . This ratio is 0.5 for  $\omega = 0$ . Therefore, the dc gain is 0.5. Also the ratio  $r/d = 1$  for  $\omega = \infty$ . Thus, the gain is unity at  $\omega = \infty$ . Also the angles of the line segments connecting the zero



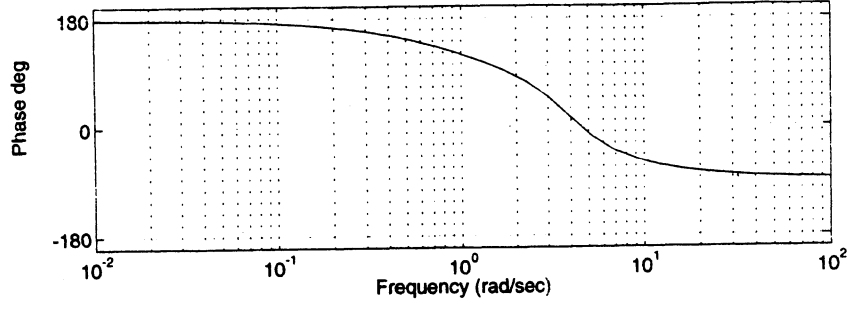
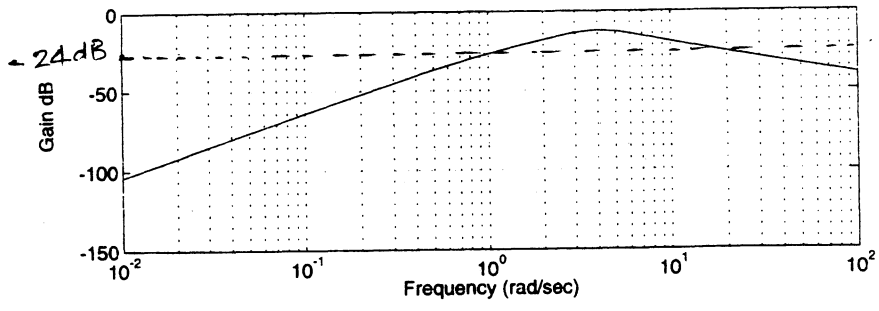

(a)

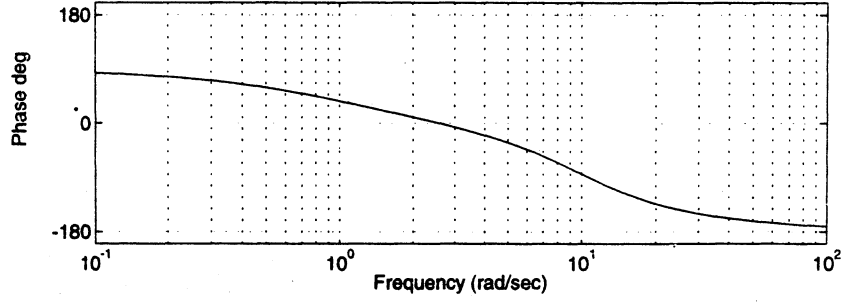
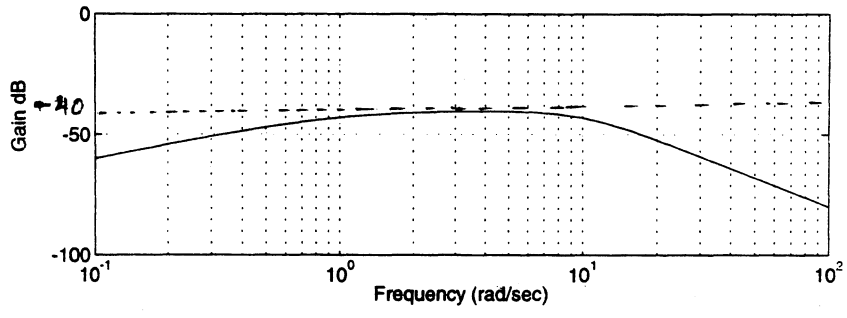

(b)

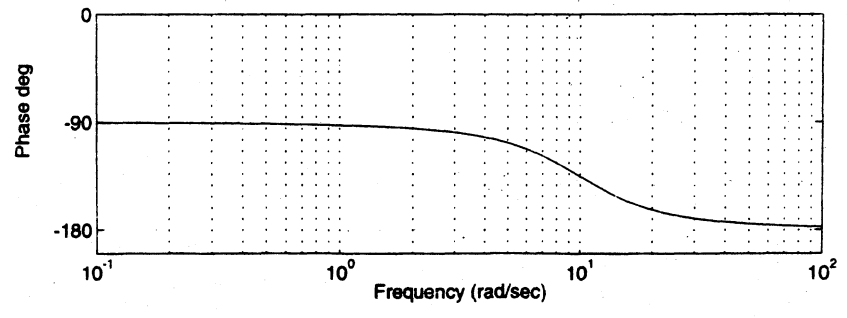
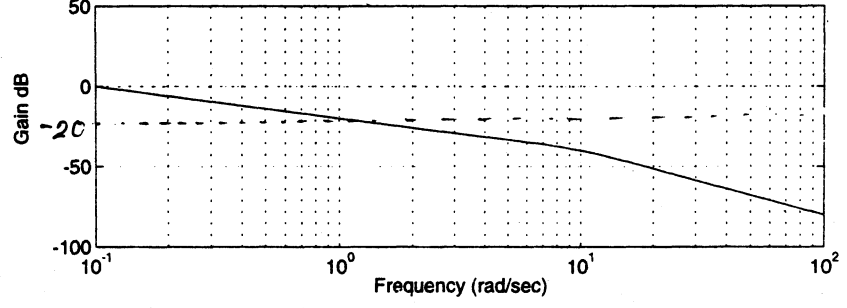

(c)

Fig. S7.2-2

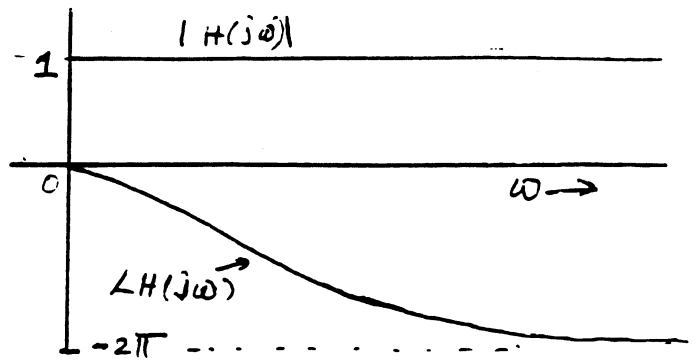
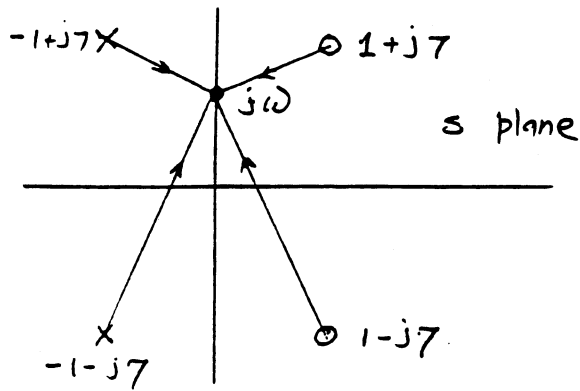

Fig. S7.4-1

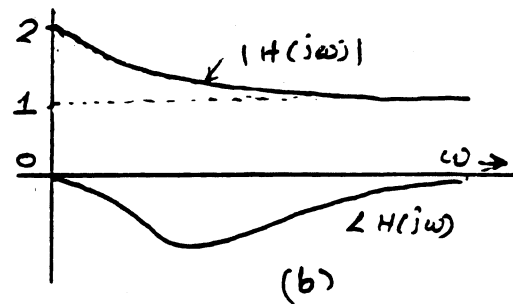
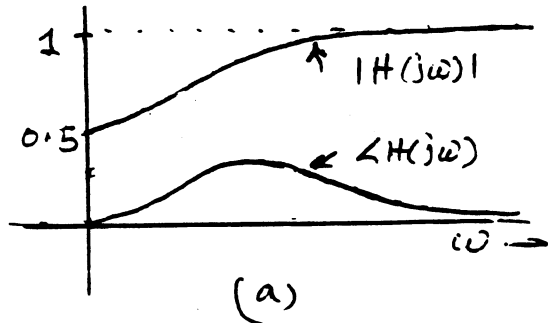

Fig. S7.4-2

and pole to the point  $j\omega$  are both zero for  $\omega = 0$ , and are both  $\pi/2$  for  $\omega = \infty$ . Therefore  $\angle H(j\omega) = 0$  at  $\omega = 0$  and  $\omega = \infty$ . In between the angle is positive as shown in Fig. S7.4-2a.

(b) In this case the ratio  $r/d$  is 2 for  $\omega = 0$ . Therefore, the dc gain is 2. Also the ratio  $r/d = 1$  for  $\omega = \infty$ . Thus, the gain is unity at  $\omega = \infty$ . Also the angles of the line segments connecting the zero and pole to the point  $j\omega$  are both zero for  $\omega = 0$ , and are both  $\pi/2$  for  $\omega = \infty$ . Therefore  $\angle H(j\omega) = 0$  at  $\omega = 0$  and  $\omega = \infty$ . In between the angle is negative as shown in Fig. S7.4-2b.

- 7.4-3 The poles are at  $-a \pm j10$ . Moreover zero gain at  $\omega = 0$  and  $\omega = \infty$  requires that there be a single zero at  $s = 0$ . This clearly causes the gain to be zero at  $\omega = 0$ . Also because there is one excess pole over zero, the gain for large values of  $\omega$  is  $1/\omega$ , which approaches 0 as  $\omega \rightarrow \infty$ . therefore, the suitable transfer function is

$$H(s) = \frac{s}{(s+a+j10)(s+a-j10)} = \frac{s}{s^2+2as+(100+a^2)}$$

The amplitude response is high in the vicinity of  $\omega = 10$  provided  $a$  is small. Smaller the  $a$ , more pronounced the gain in the vicinity of  $\omega = 10$ . For  $a = 0$ , the gain at  $\omega = 10$  is  $\infty$ .

- 7.5-1 The normalized third-order Butterworth filter transfer function poles are  $s_k = e^{j\pi/6}(2k+2)$  for  $k = 1, 2$ , and 3. Hence  $s_1 = e^{j2\pi/3} = -0.5 + j0.866$ ,  $s_2 = e^{j\pi} = -1$ , and  $s_3 = e^{j4\pi/3} = -0.5 - j0.866$ . Therefore

$$\mathcal{H}(s) = \frac{1}{(s+1)(s+0.5-j0.866)(s+0.5+j0.866)} = \frac{1}{s^3+2s^2+2s+1}$$

For  $\omega_c = 100$ , the scaled transfer function is obtained by replacing  $s$  with  $s/100$ , and hence,

$$H(s) = \frac{1}{\frac{s}{100}^3 + 2\frac{s}{100}^2 + 2\frac{s}{100} + 1} = \frac{10^6}{s^3 + 200s^2 + 20,000s + 10^6}$$

We can verify this result using Table 7.1 (or 7.2). For  $n = 3$ , we find from Table 7.1

$$\mathcal{H}(s) = \frac{1}{s^3 + 2s^2 + 2s + 1}$$

The frequency response can be found directly from Eq. (7.31) with  $\omega_c = 100$  and  $n = 3$ . Hence,

$$|H(j\omega)| = \frac{10^6}{\sqrt{10^{12} + \omega^6}}$$

- 7.5-2 (a)** Here,  $\hat{G}_p = -0.5$  dB,  $\hat{G}_s = -20$  dB,  $\omega_p = 100$ ,  $\omega_s = 200$ . From Eq. (7.39), we obtain  $n = 4.8321$ , which is rounded up to a value  $n = 5$ . To oversatisfy stopband requirement, we use Eq. (7.40) to obtain  $\omega_c = 123.412$ . To oversatisfy passband requirement, we use Eq. (7.41) to obtain  $\omega_c = 126.32$ .
- (b)** Here,  $\hat{G}_p = -0.1$  dB,  $\hat{G}_s = -60$  dB,  $\omega_p = 1000$ ,  $\omega_s = 2000$ . From Eq. (7.39), we obtain  $n = 12.678$ , which is rounded up to a value  $n = 13$ . To oversatisfy stopband requirement, we use Eq. (7.40) to obtain  $\omega_c = 1155.6$ . To oversatisfy passband requirement, we use Eq. (7.41) to obtain  $\omega_c = 1175.6$ .
- (c)** We are given  $\hat{G}_p = -3$  dB,  $\hat{G}_s = -50$  dB,  $\omega_p = \omega_c$ ,  $\omega_s = 3\omega_c$ . Here, we start with assuming  $\omega_c = 1$ . This gives  $\omega_p = 1$  and  $\omega_s = 3$ . From Eq. (7.39), we obtain  $n = 5.2419$ , which is rounded up to a value  $n = 6$ . To oversatisfy stopband requirement, we use Eq. (7.40) to obtain  $\omega_c = 1$ . Thus,  $\omega_c = \omega_c$ . To oversatisfy passband requirement, we use Eq. (7.41) to obtain  $\omega_c = 1.1494$ . Hence, in this case, we should choose  $\omega_c$  to be 1.1494 times the given value of  $\omega_c$ .
- 7.5-3** Here,  $\hat{G}_p = -3$  dB,  $\hat{G}_s = -14$  dB,  $\omega_p = 100,000$ ,  $\omega_s = 150,000$ . From Eq. (7.39), we obtain  $n = 3.931$ , which is rounded up to a value  $n = 4$ . Using Eq. (7.40), we obtain  $\omega_c = 100,060$ . The fourth-order normalized Butterworth transfer function (see Table 7.1) is

$$\mathcal{H}(s) = \frac{1}{s^4 + 2.613s^3 + 3.414s^2 + 2.613s + 1}$$

The desired transfer function is obtained by replacing  $s$  with  $s/\omega_c$  in  $\mathcal{H}(s)$ . Using  $\omega_c = 100,060$ , we obtain

$$H(s) = \frac{1.002 \times 10^{20}}{s^4 + (2.613)10^5 s^3 + (3.418)10^{10} s^2 + (2.613)10^{15} s + (1.002)10^{20}}$$

- 7.6-1** We need to find a 3rd-order Chebychev filter with  $\omega_p = 100$  and  $\hat{r} = 3$  dB. This gives  $\epsilon = \sqrt{10^{0.3} - 1} = 0.9976$ . We use Eq. 97.51) to find the poles of the normalized Cheby filter. we have  $x = \frac{1}{3} \sinh^{-1}(\frac{1}{\epsilon}) = \frac{1}{3} \sinh^{-1}(1.0024) = 0.2943$ . Now from Eq. (7.51), we compute the three poles (for  $k = 1, 2, 3$ ) as  $s_1 = -0.2986$ ,  $s_{2,3} = -0.1493 \pm j0.9038$ . Hence,

$$\begin{aligned} \mathcal{H}(s) &= \frac{0.2506}{(s + 0.2986)(s + 0.1493 + j0.9038)(s + 0.1493 - j0.9038)} \\ &= \frac{0.2506}{s^3 + 0.5972s^2 + 0.9283s + 0.2506} \end{aligned}$$

To obtain  $H(s)$ , we replace  $s$  with  $s/100$ , to obtain

$$H(s) = \frac{250,600}{s^3 + 59.72s^2 + 9283s + 250,600}$$

- 7.6-2** Here,  $\hat{G}_p = -1$  ( $\hat{r} = 1$ ) dB,  $\hat{G}_s = -22$  dB,  $\omega_p = 100$ ,  $\omega_s = 200$ . From Eq. (7.49b), we obtain  $n = 2.9599$ , which is rounded up to a value  $n = 3$ . Using Table 7.4 (for  $\hat{r} = 1$ ), we obtain the normalized Cheby transfer function as

$$\mathcal{H}(s) = \frac{0.4913}{s^3 + 0.9883s^2 + 1.238s + 0.4913}$$

The desired transfer function is obtained by replacing  $s$  with  $s/\omega_p$  in  $\mathcal{H}(s)$ . Using  $\omega_p = 100$ , we obtain

$$H(s) = \frac{(4.913)10^5}{s^3 + 98.83s^2 + 12380s + 491300}$$

- 7.6-3** Here,  $\hat{G}_p = -2$  ( $\hat{r} = 2$ ) dB,  $\hat{G}_s = -25$  dB,  $\omega_p = 10$ ,  $\omega_s = 15$ . From Eq. (7.49b), we obtain  $n = 3.9873$ , which is rounded up to a value  $n = 4$ . Also, in this case,  $K_n = a_0/(10^{\hat{r}/20}) = a_0/1.2589$ . Using Table 7.4 (for  $\hat{r} = 2$ ), we obtain the normalized Cheby transfer function

$$\mathcal{H}(s) = \frac{0.2058/1.2589}{s^4 + 0.7162s^3 + 1.256s^2 + 0.5168s + 0.2058}$$

The desired transfer function is obtained by replacing  $s$  with  $s/\omega_p$  in  $\mathcal{H}(s)$ . Using  $\omega_p = 10$ , we obtain

$$H(s) = \frac{1634}{s^4 + 7.162s^3 + 125.6s^2 + 516.8s + 2058}$$

- 7.6-4** Here,  $\hat{G}_p = -3$  ( $\hat{r} = 3$ ) dB,  $\hat{G}_s = -50$  dB,  $\omega_p = \omega_c$ ,  $\omega_s = 3\omega_c$ .

As in Prob. 7.5-2c, we assume  $\omega_c = 1$ . This results in  $\omega_p = 1$  and  $\omega_s = 3$ . From Eq. (7.49b), we obtain  $n = 3.6602$ , which is rounded up to a value  $n = 4$ . Also, in this case,  $K_n = a_0/10^{\hat{r}/20} = a_0/1.4125$ . Using Table 7.4 (for  $\hat{r} = 3$ ), we obtain the normalized Cheby transfer function

$$\mathcal{H}(s) = \frac{0.177/1.4125}{s^4 + 0.5816s^3 + 1.169s^2 + 0.4048s + 0.177}$$

The desired transfer function is obtained by replacing  $s$  with  $s/\omega_c$  in  $\mathcal{H}(s)$ .

$$H(s) = \frac{0.1253\omega_c^4}{s^4 + 0.5816\omega_c s^3 + 1.169\omega_c^2 s^2 + 0.4048\omega_c^3 s + 0.177\omega_c^4}$$

**7.7-1** Here,  $\hat{G}_p = -1$  dB,  $\hat{G}_s = -20$  dB,  $\omega_p = 20$ ,  $\omega_s = 10$ . The prototype lowpass filter specifications are  $\hat{G}_p = -1$  dB,  $\hat{G}_s = -20$  dB,  $\omega_p = 1$ ,  $\omega_s = 2$ . Use of Eq. (7.39) yields  $n = 4.9997$ , which is rounded up to  $n = 5$ . Also use of Eq. (7.40) yields  $\omega_c = 1.2341$ . From Table 7.1,  $n = 5$  yields

$$\mathcal{H}(s) = \frac{1}{s^5 + 3.236s^4 + 5.236s^3 + 5.236s^2 + 3.236s + 1}$$

We now substitute  $s$  with  $s/\omega_c = s/1.2341$  in  $\mathcal{H}(s)$  to obtain the prototype lowpass filter transfer function  $\mathcal{H}_p(s)$ .

$$\mathcal{H}_p(s) = \frac{2.863}{s^5 + 3.994s^4 + 7.975s^3 + 9.842s^2 + 7.5705s + 2.863}$$

The desired highpass transfer function is obtained by replacing  $s$  with  $\omega_p/s = 20/s$  in  $\mathcal{H}_p(s)$ .

$$H(s) = \frac{s^5}{s^5 + 52.44s^4 + 1375.06s^3 + 22284.32s^2 + 223192s + 1117708.7}$$

**7.7-2** Here,  $\hat{G}_p = -1$  ( $\hat{r} = 1$ ) dB,  $\hat{G}_s = -22$  dB,  $\omega_p = 20$ ,  $\omega_s = 10$ . The prototype lowpass filter specifications are  $\hat{G}_p = -1$  ( $\hat{r} = 1$ ) dB,  $\hat{G}_s = -22$  dB,  $\omega_p = 1$ ,  $\omega_s = 2$ . Use of Eq. (7.49b) yields  $n = 2.9599$ , which is rounded up to  $n = 3$ . From Table 7.4,  $n = 3$  yields the Cheby prototype lowpass transfer function

$$\mathcal{H}_p(s) = \frac{0.4913}{s^3 + 0.9883s^2 + 1.238s + 0.4193}$$

The desired highpass transfer function is obtained by replacing  $s$  with  $\omega_p/s = 20/s$  in  $\mathcal{H}_p(s)$ .

$$H(s) = \frac{s^3}{s^3 + 59.05s^2 + 942.81s + 19079.42}$$

**7.7-3** Here,  $\hat{G}_p = -3$  dB,  $\hat{G}_s = -17$  dB,  $\omega_{p1} = 100$ ,  $\omega_{p2} = 250$ ,  $\omega_{s1} = 40$ ,  $\omega_{s2} = 500$ .

Use of Eq. (7.56) yields  $\omega_{s1} = 3.9$  and  $\omega_{s2} = 3$ . The smaller of the two is 3. Hence,  $\omega_s = 3$ . To find the lowpass prototype transfer function, we use  $\omega_p = 1$ ,  $\omega_s = 3$ ,  $\hat{G}_p = -3$ ,  $\hat{G}_s = -17$ . Use of Eq. (7.39) yields  $n = 1.7745$ , which is rounded up to  $n = 2$ . Also use of Eq. (7.40) yields  $\omega_c = 1.0012$ . From Table 7.1,  $n = 2$  yields

$$\mathcal{H}(s) = \frac{1}{s^2 + 1.414s + 1}$$

We now substitute  $s$  with  $s/\omega_c = s/1.0012$  in  $\mathcal{H}(s)$  to obtain the prototype lowpass filter transfer function  $\mathcal{H}_p(s)$ .

$$\mathcal{H}_p(s) = \frac{1.0024}{s^2 + 1.4157s + 1.0024}$$

According to Eq. (7.57), the desired highpass transfer function is obtained by replacing  $s$  with  $T(s) = \frac{s^2 + 25000}{150s}$  in  $\mathcal{H}_p(s)$ .

$$H(s) = \frac{(2.255)10^4 s^4}{s^4 + 212.4s^3 + 72550s^2 + (5.31)10^6 s + (6.25)10^8}$$

**7.7-4** Here,  $\hat{G}_p = -1$  ( $\hat{r} = 1$ ) dB,  $\hat{G}_s = -17$  dB,  $\omega_{p1} = 100$ ,  $\omega_{p2} = 250$ ,  $\omega_{s1} = 40$ ,  $\omega_{s2} = 500$ .

Use of Eq. (7.56) yields  $\omega_{s1} = 3.9$  and  $\omega_{s2} = 3$ . The smaller of the two is 3. Hence,  $\omega_s = 3$ . To find the lowpass prototype transfer function, we use  $\omega_p = 1$ ,  $\omega_s = 3$ ,  $\hat{r} = 1$ ,  $\hat{G}_s = -17$ . Use of Eq. (7.49b) yields  $n = 1.8803$ , which is rounded up to  $n = 2$ . Also, in this case,  $K_n = a_0/(10^{\hat{r}/20}) = a_0/1.122$ . Using Table 7.4 (for  $\hat{r} = 1$ ), we obtain the prototype Cheby transfer function

$$\mathcal{H}_p(s) = \frac{1.1025/1.122}{s^2 + 1.098s + 1.1025} = \frac{0.9826}{s^2 + 1.098s + 1.1025}$$

According to Eq. (7.57), the desired highpass transfer function is obtained by replacing  $s$  with  $T(s) = \frac{s^2 + 25000}{150s}$  in  $\mathcal{H}_p(s)$ .

$$H(s) = \frac{(2.25)10^4 s^2}{s^4 + 164.7s^3 + 74817s^2 + 4117500s + (6.25)10^8}$$

**7.7-5** Here,  $\hat{G}_p = -3$  dB,  $\hat{G}_s = -24$  dB,  $\omega_{p1} = 20$ ,  $\omega_{p2} = 60$ ,  $\omega_{s1} = 30$ ,  $\omega_{s2} = 38$ .

Use of Eq. (7.60) yields  $\omega_{s1} = 4$  and  $\omega_{s2} = 6.2295$ . The smaller of the two is 4. Hence,  $\omega_s = 4$ . To find the lowpass prototype transfer function, we use  $\omega_p = 1$ ,  $\omega_s = 4$ ,  $\hat{G}_p = -3$ ,  $\hat{G}_s = -24$ . Use of Eq. (7.39) yields  $n = 1.9934$ , which is rounded up to  $n = 2$ . Also use of Eq. (7.40) yields  $\omega_c = 1.0012$ . From Table 7.1,  $n = 2$  yields

$$\mathcal{H}(s) = \frac{1}{s^2 + 1.414s + 1}$$

We now substitute  $s$  with  $s/\omega_c = s/1.0012$  in  $\mathcal{H}(s)$  to obtain the prototype lowpass filter transfer function  $\mathcal{H}_p(s)$ .

$$\mathcal{H}_p(s) = \frac{1.002}{s^2 + 1.4157s + 1.002}$$

According to Eq. (7.61), the desired bandstop transfer function is obtained by replacing  $s$  with  $T(s) = \frac{40s}{s^2 + 1200}$  in  $\mathcal{H}_p(s)$ .

$$H(s) = \frac{(s^2 + 1200)^2}{s^4 + 56.53s^3 + 399.8s^2 + (6.7824)10^4s + (1.44)10^6}$$

# Chapter 8

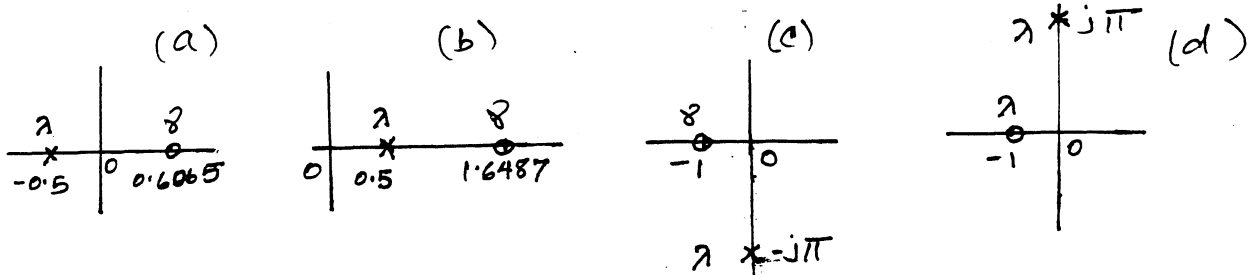

Fig. S8.2-1

- 8.2-1 (a)  $e^{-0.5k} = (0.6065)^k$ , (b)  $e^{0.5k} = (1.6487)^k$ ,  
 (c)  $e^{-j\pi k} = (e^{-j\pi})^k = (-1)^k$ , (d)  $e^{j\pi k} = (e^{j\pi})^k = (-1)^k$   
 Figure S8.2-1 shows locations of  $\lambda$  and  $\gamma$  in each case.

- 8.2-2 (a)  $e^{-(1+j\pi)k} = (e^{-1}e^{-j\pi})^k = (-\frac{1}{e})^k$  (b)  $e^{-(1-j\pi)k} = (e^{-1}e^{j\pi})^k = (-\frac{1}{e})^k$   
 (c)  $e^{(1+j\pi)k} = (e e^{j\pi})^k = (-e)^k$  (d)  $e^{(1-j\pi)k} = (e e^{-j\pi})^k = (-e)^k$   
 (e)  $e^{-(1+j\frac{\pi}{3})k} = (e^{-1})^k e^{-j\frac{\pi}{3}k} = (\frac{1}{e})^k [\cos \frac{\pi}{3}k - j \sin \frac{\pi}{3}k]$  (f)  $e^{(1-j\frac{\pi}{3})k} = (e^1)^k e^{-j\frac{\pi}{3}k} = e^k [\cos \frac{\pi}{3}k - j \sin \frac{\pi}{3}k]$

- 8.2-3 (a) Periodic because  $\Omega/2\pi = 1/4$ , rational. Using Eq. (8.9b), we find that  $N_0 = m(2\pi/\Omega) = m(4)$  is an integer for the smallest  $m = 1$ . Hence  $N_0 = 4$ . (b) Aperiodic because  $\Omega/2\pi = 1/\sqrt{2}$ , not rational.  
 (c) Aperiodic because  $\Omega/2\pi = 1/4\pi$ , not rational. (d) Periodic because  $\Omega/2\pi = 1/6$ , rational.

- 8.2-4 (a) Periodic because  $\Omega/2\pi = 3/10$ , rational. Using Eq. (8.9b), we find that  $N_0 = m(2\pi/\Omega) = m(10/3)$  is an integer for the smallest  $m = 3$ . Hence  $N_0 = 10$ .  
 (b) Periodic because  $\Omega/2\pi = 2/5$ , rational. Using the argument in part (a), we obtain  $N_0 = 5$ .  
 (a) All the three sinusoids are periodic with periods 10, 4, and 5, respectively. Because  $2(10) = 5(4) = 4(5) = 20$ , the period is 20. This is because we can fit exactly 2, 5, and 4 cycles of the three sinusoids in a period 20.

- 8.2-5 (a)  $\Omega_f = 0.8\pi$ ,  $|\Omega_f| = 0.8\pi$   
 (b)  $\Omega_f = 1.2\pi - 2\pi = -0.8\pi$ ,  $|\Omega_f| = 0.8\pi$  (c)  $\Omega_f = 6.9 - 2\pi = 0.6168$ ,  $|\Omega_f| = 0.6168$   
 (d)  $\Omega_f = 3.7\pi - 4\pi = -0.3\pi$ ,  $|\Omega_f| = 0.3\pi$  (e)  $\Omega_f = 22.9\pi - 22\pi = 0.9\pi$ ,  $|\Omega_f| = 0.9\pi$

- 8.2-6 Because  $1.4\pi = 2\pi - 0.6\pi$ ,  $\cos(1.4\pi k + \frac{\pi}{3}) = \cos(-0.6\pi k + \frac{\pi}{3}) = \cos(0.6\pi k - \frac{\pi}{3})$ . Also

$$\cos(0.6\pi k + \frac{\pi}{6}) = \cos 0.6\pi k \cos \frac{\pi}{6} - \sin 0.6\pi k \sin \frac{\pi}{6} = \frac{\sqrt{3}}{2} \cos 0.6\pi k - \frac{1}{2} \sin 0.6\pi k$$

Similarly

$$\cos(0.6\pi k - \frac{\pi}{3}) = \cos 0.6\pi k \cos \frac{\pi}{3} + \sin 0.6\pi k \sin \frac{\pi}{3} = \frac{1}{2} \cos 0.6\pi k + \frac{\sqrt{3}}{2} \sin 0.6\pi k$$

Therefore,

$$\cos(0.6\pi k + \frac{\pi}{6}) + \sqrt{3} \cos(1.4\pi k + \frac{\pi}{3}) = \sqrt{3} \cos 0.6\pi k + \sin 0.6\pi k = 2 \cos(0.6\pi k - \frac{\pi}{6})$$

- 8.2-7

- (a)  $e^{j(8.2\pi k + \theta) - j8\pi k} = e^{j(0.2\pi k + \theta)}$   
 (b)  $e^{j4\pi k - j4\pi k} = e^{j0k} = 1$   
 (c)  $e^{-j1.95k + j2\pi k} = e^{j4.333k}$   
 (d)  $e^{-j10.7\pi k + j12\pi k} = e^{j1.3\pi k}$

- 8.2-8

$$E_f = \sum_0^{\infty} (0.8)^2 = \sum_0^{\infty} (0.64)^2 = \frac{(0.64)^{\infty} - (0.64)^0}{0.64 - 1} = 2.7778$$

Rest is trivial. The energy of  $-f[k]$  is  $E_f = 2.7778$ , and the energy of  $cf[k]$  is  $c^2 E_f = 2.7778c^2$ .

8.2-9

(a)  $E_f = (3)^2 + 2(2)^2 + 2(1)^2 = 19$  (b)  $E_f = (3)^2 + 2(2)^2 + 2(1)^2 = 19$   
 (c)  $E_f = 2(3)^2 + 2(6)^2 + 2(9)^2 = 252$  (d)  $E_f = 2(2)^2 + 2(4)^2 = 40$

8.2-10 (a)  $P_f = \lim_{N \rightarrow \infty} \frac{1}{2N+1} \sum_{-N}^N (1)^{2k} = 1$  (b)  $P_f = \lim_{N \rightarrow \infty} \frac{1}{2N+1} \sum_{-N}^N (-1)^{2k} = 1$   
 (c)  $P_f = \lim_{N \rightarrow \infty} \frac{1}{2N+1} \sum_0^N (1)^2 = 0.5$  (d)  $P_f = \lim_{N \rightarrow \infty} \frac{1}{2N+1} \sum_0^N (-1)^{2k} = 0.5$

(e)  $N_0 = \frac{2\pi}{\frac{\pi}{3}} = 6$ ,  $P_f = \frac{1}{6} \sum_0^5 (\cos[\frac{\pi}{3}k + \frac{\pi}{6}])^2 = \frac{1}{6} \left[ \left(\frac{\sqrt{3}}{2}\right)^2 + 0^2 + \left(-\frac{\sqrt{3}}{2}\right)^2 + \left(-\frac{\sqrt{3}}{2}\right)^2 + 0^2 + \left(\frac{\sqrt{3}}{2}\right)^2 \right] = 0.5$

8.2-11 (a)  $P_f = \frac{1}{6}[(3)^2 + 2(2)^2 + 2(1)^2] = \frac{19}{6}$  (b)  $P_f = \frac{1}{12}[2(1)^2 + 2(2)^2 + 2(3)^2] = \frac{7}{3}$

8.2-12 (a) In the following discussion, let  $\frac{2\pi}{N_0} = \Omega_0$ . Because  $D e^{j\Omega_0 k}$  is periodic with period  $N_0$

$$P_f = \frac{1}{N_0} \sum_{k=0}^{N_0-1} |D e^{j\Omega_0 k}|^2 = \frac{1}{N_0} \sum_{k=0}^{N_0-1} |D|^2 = |D|^2$$

(b)

$$P_f = \frac{1}{N_0} \sum_{k=0}^{N_0-1} \left| \sum_{r=0}^{N_0-1} D_r e^{jr\Omega_0 k} \right|^2 = \frac{1}{N_0} \sum_{k=0}^{N_0-1} \left[ \sum_{r=0}^{N_0-1} D_r e^{jr\Omega_0 k} \sum_{m=0}^{N_0-1} D_m^* e^{-jm\Omega_0 k} \right]$$

Interchanging the order of summation yields

$$P_f = \frac{1}{N_0} \sum_{r=0}^{N_0-1} \sum_{m=0}^{N_0-1} D_r D_m^* \left[ \sum_{k=0}^{N_0-1} e^{j(r-m)\Omega_0 k} \right]$$

From Eq. (5.43) in Appendix 5.1, the sum inside the parenthesis is  $N_0$  when  $r = m$ , and is zero otherwise. Hence

$$P_f = \sum_{r=0}^{N_0-1} |D_r|^2$$

8.3-1 In the present case,  $\mathcal{F}_s = 1/T = 2$  MHz. Therefore Eq. (8.21) yields

$$2 \times 10^6 = 0 + 2 \times 10^6$$

Hence, the reduced frequency is 0 (dc).

8.3-2 For the sinusoid  $10 \cos(11\pi t + \frac{\pi}{6})$ , the samples sinusoid, obtained by replacing  $t$  with  $kT = 0.1k$ , is

$$10 \cos\left(\frac{11}{10}\pi k + \frac{\pi}{6}\right) = 10 \cos\left[\left(2\pi - \frac{9\pi}{10}\right)k + \frac{\pi}{6}\right] = 10 \cos\left(-\frac{9}{10}\pi k + \frac{\pi}{6}\right) = 10 \cos\left(\frac{9}{10}\pi k - \frac{\pi}{6}\right)$$

For the sinusoid  $5 \cos(29\pi t - \frac{\pi}{6})$ , the samples sinusoid (obtained by replacing  $t$  with  $kT = 0.1k$ ) is

$$5 \cos\left(\frac{29}{10}\pi k - \frac{\pi}{6}\right) = 5 \cos\left[\left(2\pi + \frac{9\pi}{10}\right)k - \frac{\pi}{6}\right] = 5 \cos\left(\frac{9}{10}\pi k - \frac{\pi}{6}\right)$$

8.3-3 (a) In this case,  $T = 1/4000$ . Hence, the sampled signal, which is obtained by replacing  $t$  with  $kT = k/4000$ , is

$$\begin{aligned} 10 \cos \frac{\pi}{2} k + \sqrt{2} \sin \frac{3\pi}{4} k + 2 \cos \left( \frac{5\pi}{4} k + \frac{\pi}{4} \right) &= 10 \cos \frac{\pi}{2} k + \sqrt{2} \sin \frac{3\pi}{4} k + 2 \cos \left( \frac{-3\pi}{4} k + \frac{\pi}{4} \right) \\ &= 10 \cos \frac{\pi}{2} k + \sqrt{2} \sin \frac{3\pi}{4} k + 2 \cos \left( \frac{3\pi}{4} k - \frac{\pi}{4} \right) \end{aligned}$$

We can combine the last 2 terms by using a suitable trigonometric identity as follows:

$$\begin{aligned} \sqrt{2} \sin \frac{3\pi}{4} k + 2 \cos \left( \frac{3\pi}{4} k - \frac{\pi}{4} \right) &= \sqrt{2} \sin \frac{3\pi}{4} k + 2 \cos \frac{3\pi}{4} k \cos \frac{\pi}{4} + 2 \sin \frac{3\pi}{4} k \sin \frac{\pi}{4} \\ &= \sqrt{2} \sin \frac{3\pi}{4} k + \sqrt{2} \cos \frac{3\pi}{4} k + \sqrt{2} \sin \frac{3\pi}{4} k \\ &= 2\sqrt{2} \sin \frac{3\pi}{4} k + \sqrt{2} \cos \frac{3\pi}{4} k = \sqrt{10} \cos \left( \frac{3\pi}{4} k - 1.107 \right) \end{aligned}$$

The frequency  $5\pi/4$  has been reduced to  $3\pi/4$ . this indicates aliasing.

(b) The highest frequency in the signal is  $\omega = 5000\pi$  or 2500 Hz. Hence, the maximum value of  $T$  that can be used without aliasing is  $T = 1/(2 \times 2500) = 1/5000$ .

8.3-4 In this case,  $\mathcal{F}_s = 1/10^{-4} = 10,000$ . Use of Eq. (8.21) yields

- (i)  $1500 = 1500 + 0 \times 10,000 \Rightarrow |\mathcal{F}_f| = 1500$
- (ii)  $8500 = -1500 + 1 \times 10,000 \Rightarrow |\mathcal{F}_f| = 1500$
- (iii)  $10,000 = 0 + 1 \times 10,000 \Rightarrow |\mathcal{F}_f| = 0$
- (iv)  $11,500 = 1500 + 1 \times 10,000 \Rightarrow |\mathcal{F}_f| = 1500$
- (v)  $32,000 = 2000 + 3 \times 10,000 \Rightarrow |\mathcal{F}_f| = 2000$
- (vi)  $9600 = 600 + 9 \times 10,000 \Rightarrow |\mathcal{F}_f| = 600$

8.4-1 Figure S8.4-1 shows all the signals

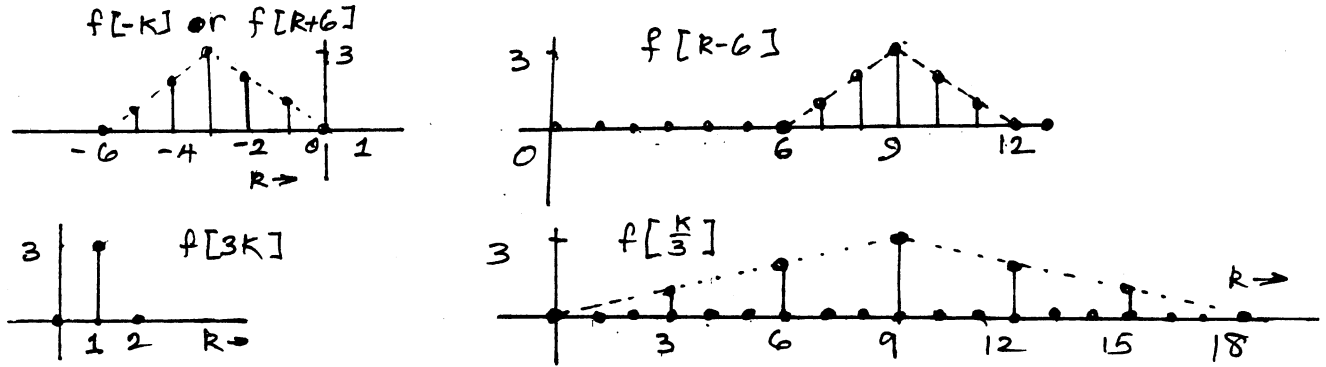

Fig. S8.4-1

8.4-2 Figure S8.4-2 shows all the signals

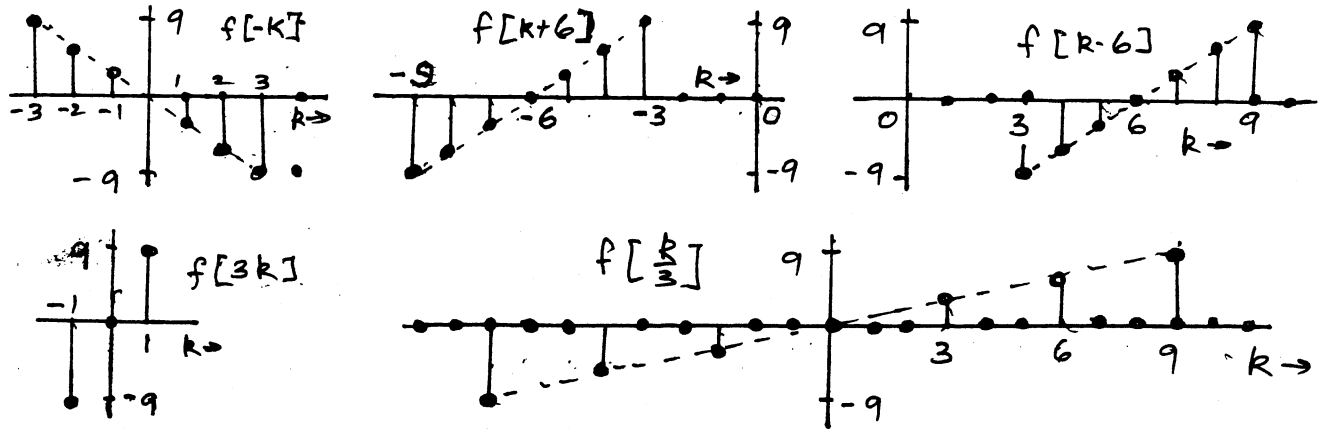

Fig. S8.4-2

8.4-3 Figure S8.4-3 shows all the signals

8.4-4 (a)  $f[k] = (k+3)(u[k+3] - u[k]) + (-k+3)(u[k] - u[k-4])$

(b)  $f[k] = k(u[k] - u[k-4]) + (-k+6)(u[k-4] - u[k-7])$

(c)  $f[k] = k(u[k+3] - u[k-4])$  (d)  $f[k] = -2k(u[k+2] - u[k]) + 2k(u[k] - u[k-3])$

In all four cases,  $f[k]$  may be represented by several other (slightly different) expressions. For instance, in case (a), we may also use  $f[k] = (k+3)(u[k+3] - u[k-1]) + (-k+3)(u[k-1] - u[k-4])$ . Moreover because  $f[k] = 0$  at  $k = \pm 3$ ,  $u[k+3]$  and  $u[k-4]$  may be replaced with  $u[k+2]$  and  $u[k-3]$ , respectively. Similar observations apply to other cases also.

8.4-5  $E_{f[k-m]} = \sum_{k=-\infty}^{\infty} |f[k-m]|^2 = \sum_{r=-\infty}^{\infty} |f[r]|^2 = E_f$ .

8.4-6 (a) is trivial. (b)  $P_{f[-k]} = \lim_{N \rightarrow \infty} \frac{1}{2N+1} \sum_{k=-N}^N |f[-k]|^2 = \lim_{N \rightarrow \infty} \frac{1}{2N+1} \sum_{r=-N}^N |f[r]|^2 = P_f$ .



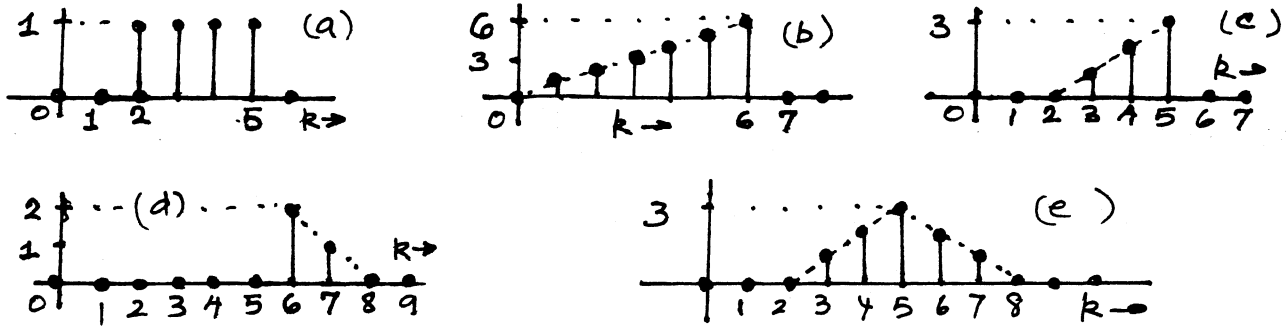

Fig. S8.4-3

$$(c) P_{f[k-m]} = \lim_{N \rightarrow \infty} \frac{1}{2N+1} \sum_{k=-N}^N |f[k-m]|^2 = \lim_{N \rightarrow \infty} \frac{1}{2N+1} \sum_{r=-N-m}^{N-m} |f[r]|^2 = P_f$$

$$(d) P_{cf} = \lim_{N \rightarrow \infty} \frac{1}{2N+1} \sum_{k=-N}^N c^2 |f[k]|^2 = c^2 P_f$$

8.5-1 Because  $y[k] = y[k-1] + f[k]$ ,

$$y[k] - y[k-1] = f[k]$$

Realization of this equation is shown in Fig. S8.5-1. If there were a sales tax of 10%, the difference equation becomes

$$y[k] = y[k-1] + 1.1f[k] \quad \text{and} \quad y[k] - y[k-1] = 1.1f[k]$$

The system realization would be the same except there is a multiplier of 1.1 at the input.

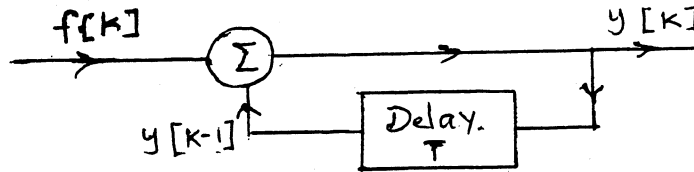

Fig. S8.5-1

8.5-2 The net growth rate of the native population is  $3.3 - 1.3 = 2\%$  per year. Assuming the immigrants enter at a uniform rate throughout the year, their birth and death rate will be  $(3.3/2)\%$  and  $(1.3/2)\%$ , respectively of the immigrants at the end of the year. The population  $p[k]$  at the beginning of the  $k$ th year is  $p[k-1]$  plus the net increase in the native population plus  $i[k-1]$ , the immigrants entering during  $(k-1)$ st year plus the net increase in the immigrant population for the year  $(k-1)$ .

$$p[k] = p[k-1] + \frac{3.3-1.3}{100} p[k-1] + i[k-1] + \frac{3.3-1.3}{2 \times 100} i[k-1]$$

$$= 1.02p[k-1] + 1.01i[k-1]$$

or

$$p[k] - 1.02p[k-1] = 1.01i[k-1]$$

or

$$p[k+1] - 1.02p[k] = 1.01i[k]$$

8.5-3 The area under  $f(t)$  from 0 to  $kT$  is  $y(kT)$ . Similarly, the area from 0 to  $(k-1)T$  is  $y((k-1)T)$ . But this area is equal to  $Tf((k-1)T)$  (in the limit  $T \rightarrow 0$ ). Now, using the notation  $y[k]$  to denote  $y(kT)$ , etc., it follows that (assuming  $T$  to be small)

$$y[k] - y[k-1] = Tf[k-1]$$

If the input is  $u(t)$ , then  $f[k] = u[k]$ . The equation is  $y[k] - y[k-1] = Tu[k-1]$ . Setting  $k=0$  in this equation and using the fact that  $y[-1]=0$ , we obtain  $y[0]=0$ . Setting  $k=1$  and using the fact that  $y[0]=0$ , we obtain  $y[1]=T$ . Continuing this way, we obtain  $y[k]=kTu[k]$ .

When the integrator equation is  $y[k] - y[k-1] = Tf[k]$ , a similar argument shows that  $y[0]=T$ ,  $y[1]=2T$ , and in general  $y[k]=(k+1)T = kTu[k] + T$ .

8.5-4

$$y[k] = \frac{1}{5} \{f[k] + f[k-1] + f[k-2] + f[k-3] + f[k-4]\}$$

The realization is shown in Fig. S8.5-4.

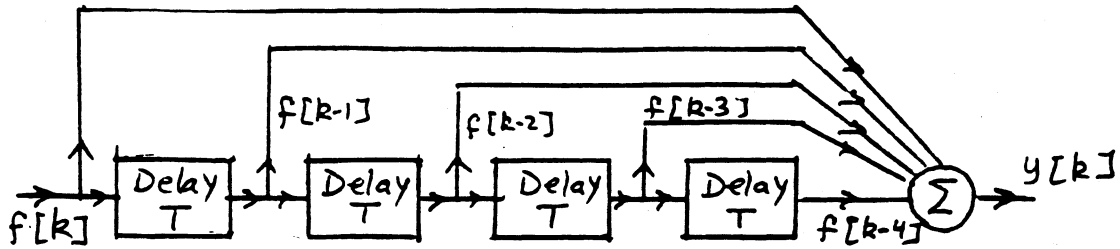

Fig. S8.5-4

8.5-5 The node equation at the  $k$ th node is  $i_1 + i_2 + i_3 = 0$ , or

$$\frac{v[k-1] - v[k]}{R} + \frac{v[k+1] - v[k]}{R} - \frac{v[k]}{aR} = 0$$

Therefore

$$a(v[k-1] + v[k+1] - 2v[k]) - v[k] = 0$$

or

$$v[k+1] - \left(2 + \frac{1}{a}\right)v[k] + v[k-1] = 0$$

that is

$$v[k+2] - \left(2 + \frac{1}{a}\right)v[k+1] + v[k] = 0$$

# Chapter 9

---

9.1-1 (a)

$$y[k+1] = 0.5y[k] \quad (1)$$

Setting  $k = -1$  and substituting  $y[-1] = 10$ , yields

$$y[0] = 0.5(10) = 5$$

Setting  $k = 0$ , and substituting  $y[0] = 5$ , yields

$$y[1] = 0.5(5) = 2.5$$

Setting  $k = 1$  in (1), and substituting  $y[1] = 2.5$ , yields

$$y[2] = 0.5(2.5) = 1.25$$

(b)

$$y[k+1] = -2y[k] + f[k+1] \quad (2)$$

Setting  $k = -1$ , and substituting  $y[-1] = 0$ ,  $f[0] = 1$ , yields

$$y[0] = 0 + 1 = 1$$

Setting  $k = 0$ , and substituting  $y[0] = 1$ ,  $f[1] = \frac{1}{e}$ , yields

$$y[1] = -2(1) + \frac{1}{e} = -2 + \frac{1}{e} = -1.632$$

Setting  $k = 1$  in (1), and substituting  $y[1] = -2 + \frac{1}{e}$ ,  $f[2] = \frac{1}{e^2}$ , yields

$$y[2] = -2(-2 + \frac{1}{e}) + \frac{1}{e^2} = 4 - \frac{2}{e} + \frac{1}{e^2} = 3.399$$

9.1-2

$$y[k] = 0.6y[k-1] + 0.16[k-2]$$

Setting  $k = 0$ , and substituting  $y[-1] = -25$ ,  $y[-2] = 0$ , yields

$$y[0] = 0.6(-25) + 0.16(0) = -15$$

Setting  $k = 1$ , and substituting  $y[-1] = 0$ ,  $y[0] = -15$ , yields

$$y[1] = 0.6(-15) + 0.16(-25) = -13$$

Setting  $k = 2$ , and substituting  $y[1] = -13$ ,  $y[0] = -15$ , yields

$$y[2] = 0.6(-13) + 0.16(-15) = -10.2$$

9.1-3 This equation can be expressed as

$$y[k+2] = -\frac{1}{4}y[k+1] - \frac{1}{16}y[k] + f[k+2]$$

Setting  $k = -2$ , and substituting  $y[-1] = y[-2] = 0$ ,  $f[0] = 100$ , yields

$$y[0] = -\frac{1}{4}(0) - \frac{1}{16}(0) + 100 = 100$$

Setting  $k = -1$ , and substituting  $y[-1] = 0$ ,  $y[0] = 100$ ,  $f[1] = 100$ , yields

$$y[1] = -\frac{1}{4}(100) - \frac{1}{16}(0) + 100 = 75$$

Setting  $k = 0$ , and substituting  $y[0] = 100$ ,  $y[1] = 75$ ,  $f[2] = 100$ , yields

$$y[2] = -\frac{1}{4}(75) - \frac{1}{16}(100) + 100 = 75$$

## 9.1-4

$$y[k+2] = -3y[k+1] - 2y[k] + f[k+2] + 3f[k+1] + 3f[k]$$

Setting  $k = -2$ , and substituting  $y[-1] = 3$ ,  $y[-2] = 2$ ,  $f[-1] = f[-2] = 0$ ,  $f[0] = 1$ , yields

$$y[0] = -3(3) - 2(2) + 1 + 3(0) + 3(0) = -12$$

Setting  $k = -1$ , and substituting  $y[0] = -12$ ,  $y[-1] = 3$ ,  $f[-1] = 0$ ,  $f[0] = 1$ ,  $f[1] = 3$ , yields

$$y[1] = -3(-12) - 2(3) + 3 + 3(1) + 3(0) = 36$$

Proceeding along same lines, we obtain

$$y[2] = -3(36) - 2(-12) + 9 + 3(3) + 3(1) = -63$$

## 9.1-5

$$y[k] = -2y[k-1] - y[k-2] + 2f[k] - f[k-1]$$

Setting  $k = 0$ , and substituting  $y[-1] = 2$ ,  $y[-2] = 3$ ,  $f[0] = 1$ ,  $f[-1] = 0$ , yields

$$y[0] = -2(2) - 3 + 2(1) - 0 = -5$$

Setting  $k = 1$ , and substituting  $y[0] = -5$ ,  $y[-1] = 2$ ,  $f[0] = 1$ ,  $f[1] = \frac{1}{3}$ , yields

$$y[1] = -2(-5) - (2) + 2\left(\frac{1}{3}\right) - 1 = 7.667$$

Setting  $k = 2$ , and substituting  $y[1] = 7.667$ ,  $y[0] = -5$ ,  $f[1] = \frac{1}{3}$ ,  $f[2] = \frac{1}{9}$ , yields

$$y[2] = -2(7.667) - (-5) + 2\left(\frac{1}{9}\right) - \frac{1}{3} = -5.445$$

## 9.2-1

$$(E^2 + 3E + 2)y[k] = 0$$

The characteristic equation is  $\gamma^2 + 3\gamma + 2 = (\gamma + 1)(\gamma + 2) = 0$ . Therefore

$$y[k] = c_1(-1)^k + c_2(-2)^k$$

Setting  $k = -1$  and  $-2$  and substituting initial conditions yields

$$\left. \begin{array}{l} 0 = -c_1 - \frac{1}{2}c_2 \\ 1 = c_1 + \frac{1}{4}c_2 \end{array} \right\} \Rightarrow \begin{array}{l} c_1 = 2 \\ c_2 = -4 \end{array}$$

$$y[k] = 2(-1)^k - 4(-2)^k \quad k \geq 0$$

## 9.2-2

$$(E^2 + 2E + 1)y[k] = 0$$

The characteristic equation is  $\gamma^2 + 2\gamma + 1 = (\gamma + 1)^2 = 0$ .

$$y[k] = (c_1 + c_2 k)(-1)^k$$

Setting  $k = -1$  and  $-2$  and substituting initial conditions yields

$$\left. \begin{array}{l} 1 = -c_1 + c_2 \\ 1 = c_1 - 2c_2 \end{array} \right\} \Rightarrow \begin{array}{l} c_1 = -3 \\ c_2 = -2 \end{array}$$

$$y[k] = -(3 + 2k)(-1)^k$$

## 9.2-3

$$(E^2 - 2E + 2)y[k] = 0$$

The characteristic equation is  $\gamma^2 - 2\gamma + 2 = (\gamma - 1 - j1)(\gamma - 1 + j1) = 0$ . The roots are  $1 \pm j1 = \sqrt{2}e^{\pm j\pi/4}$ .

$$y[k] = c(\sqrt{2})^k \cos\left(\frac{\pi}{4}k + \theta\right)$$

Setting  $k = -1$  and  $-2$  and substituting initial conditions yields

$$1 = \frac{c}{\sqrt{2}} \cos\left(-\frac{\pi}{4} + \theta\right) = \frac{c}{\sqrt{2}} \left(\frac{1}{\sqrt{2}} \cos \theta + \frac{1}{\sqrt{2}} \sin \theta\right)$$

$$0 = \frac{c}{2} \cos\left(-\frac{\pi}{2} + \theta\right) = \frac{c}{2} \sin \theta$$

Solution of these two simultaneous equations yields

$$\left. \begin{aligned} c \cos \theta &= 2 \\ c \sin \theta &= 0 \end{aligned} \right\} \implies \begin{aligned} c &= 2 \\ \theta &= 0 \end{aligned}$$

$$y[k] = 2(\sqrt{2})^k \cos\left(\frac{\pi}{4}k\right)$$

**9.2-4**

$$v(k+2) - 2.5v(k+1) + v(k) = 0$$

The auxiliary conditions are  $v(0) = 100$ ,  $v(N) = 0$ .

$$(E^2 - 2.5E + 1)v[k] = 0$$

The characteristic equation is  $\gamma^2 - 2.5\gamma + 1 = (\gamma - 0.5)(\gamma - 2) = 0$ .

$$v(k) = c_1(0.5)^k + c_2(2)^k$$

Setting  $k = 0$  and  $N$ , and substituting  $v(0) = 100$ ,  $v(N) = 0$ , yields

$$\left. \begin{aligned} 100 &= c_1 + c_2 \\ 0 &= c_1(0.5)^N + c_2(2)^N \end{aligned} \right\} \implies \begin{aligned} c_1 &= \frac{100(2)^N}{2^N - (0.5)^N} \\ c_2 &= \frac{100(0.5)^N}{(0.5)^N - 2^N} \end{aligned}$$

$$v[k] = \frac{100}{2^N - (0.5)^N} [2^N(0.5)^k - (0.5)^N(2)^k] \quad k = 0, 1, \dots, N$$

**9.3-1**

$$(E + 2)y[k] = f[k]$$

The characteristic equation is  $\gamma + 2 = 0$ . The characteristic root is  $-2$ . Also  $a_0 = 2$ ,  $b_0 = 1$ . Therefore

$$h[k] = \frac{1}{2}\delta[k] + c(-2)^k \quad (1)$$

We need one value of  $h[k]$  to determine  $c$ . This is determined by iterative solution of

$$(E + 2)h[k] = \delta[k]$$

or

$$h[k+1] + 2h[k] = \delta[k]$$

Setting  $k = -1$ , and substituting  $h[-1] = \delta[-1] = 0$ , yields

$$h[0] = 0$$

Setting  $k = 0$  in Eq. (1) and using  $h[0] = 0$  yields

$$0 = \frac{1}{2} + c \implies c = -\frac{1}{2}$$

Therefore

$$h[k] = \frac{1}{2}\delta[k] - \frac{1}{2}(-2)^k u[k]$$

**9.3-2** The characteristic root is  $-2$ ,  $b_0 = 0$ ,  $a_0 = 2$ . Therefore

$$h[k] = c(-2)^k \quad (1)$$

We need one value of  $h[k]$  to determine  $c$ . This is done by solving iteratively

$$h[k+1] + 2h[k] = \delta[k+1]$$

Setting  $k = -1$ , and substituting  $h[-1] = 0$ ,  $\delta[0] = 1$ , yields

$$h[0] = 1$$

Setting  $k = 0$  in Eq. (1) and using  $h[0] = 1$  yields

$$1 = c$$

and

$$h[k] = (-2)^k u[k]$$

**9.3-3** Characteristic equation is  $\gamma^2 - 6\gamma + 9 = (\gamma - 3)^2 = 0$ . Also  $a_0 = 9$ ,  $b_0 = 0$ . Therefore

$$h[k] = (c_1 + c_2 k)3^k u[k] \quad (1)$$

We need two values of  $h[k]$  to determine  $c_1$  and  $c_2$ . This is found from iterative solution of

$$(E^2 - 6E + 9)h[k] = E\delta[k]$$

or

$$h[k+2] - 6h[k+1] + 9h[k] = \delta[k+1] \quad (2)$$

Also  $h[-1] = h[-2] = \delta[-1] = 0$  and  $\delta[0] = 1$ . Setting  $k = -2$  in (2) yields

$$h[0] - 6(0) + 9(0) = 0 \implies h[0] = 0$$

Setting  $k = -1$  in (2) yields

$$h[1] - 6(0) + 9(0) = 1 \implies h[1] = 1$$

Setting  $k = 0$  and 1 in Eq. (1) and substituting  $h[0] = 0$ ,  $h[1] = 1$  yields

$$\left. \begin{array}{l} 0 = c_1 \\ 1 = 3(c_1 + c_2) \end{array} \right\} \implies \begin{array}{l} c_1 = 0 \\ c_2 = \frac{1}{3} \end{array}$$

and

$$h[k] = \frac{1}{3}k(3)^k u[k]$$

**9.3-4**

$$(E^2 - 6E + 25)y[k] = (2E^2 - 4E)f[k]$$

The characteristic roots are  $5e^{\pm j0.923}$ ,  $b_0 = 0$ . Therefore

$$h[k] = c(5)^k \cos(0.923k + \theta)u[k] \quad (1)$$

We need two values of  $h[k]$  to determine  $c$  and  $\theta$ . This is done by solving iteratively

$$h[k] - 6h[k-1] + 25h[k-2] = 2\delta[k] - 4\delta[k-1] \quad (2)$$

Setting  $k = 0$  yields

$$h[0] - 6(0) + 25(0) = 2(1) - 4(0) \implies h[0] = 2$$

Setting  $k = 1$  in (2) yields

$$h[1] - 6(2) + 25(0) = 2(0) - 4 \implies h[1] = 8$$

Setting  $k = 0, 1$  in (1) and substituting  $h[0] = 2$ ,  $h[1] = 8$  yields

$$\begin{aligned} 2 &= c \cos \theta \\ 8 &= 5c \cos(0.923 + \theta) = 3.017c \cos \theta - 3.987c \sin \theta \end{aligned}$$

Solution of these two equations yields

$$\left. \begin{array}{l} c \cos \theta = 2 \\ c \sin \theta = -0.4931 \end{array} \right\} \implies \begin{array}{l} c = 2.061 \\ \theta = -0.244 \text{ rad} \end{array}$$

and

$$h[k] = 2.061(5)^k \cos(0.923k - 0.244)u[k]$$

**9.3-5 (a)**

$$E^n y[k] = (b_n E^n + b_{n-1} E^{n-1} + \dots + b_0) f[k]$$

or

$$y[k] = b_n f[k] + b_{n-1} f[k-1] + \dots + b_0 f[k-n]$$

When  $f[k] = \delta[k]$ ,  $y[k] = h[k]$ . Therefore

$$h[k] = b_n \delta[k] + b_{n-1} \delta[k-1] + \dots + b_0 \delta[k-n]$$

(b) Here  $n = 3$ ,  $b_3 = 3$ ,  $b_2 = -5$ ,  $b_1 = 0$ ,  $b_0 = -2$ . Therefore

$$h[k] = 3\delta[k] - 5\delta[k-1] - 2\delta[k-3]$$

9.4-1

$$\begin{aligned} y[k] &= e^{-k} u[k] * (-2)^k u[k] = \left(\frac{1}{e}\right)^k u[k] * (-2)^k u[k] \\ &= \frac{(1/e)^{k+1} - (-2)^{k+1}}{(1/e) + 2} u[k] = \frac{e}{2e+1} [e^{-(k+1)} - (-2)^{k+1}] u[k] \end{aligned}$$

9.4-2

$$\begin{aligned} y[k] &= e^{-k} u[k] * \left\{ \frac{1}{2} \delta[k] - \frac{1}{2} (-2)^k u[k] \right\} \\ &= \frac{1}{2} e^{-k} u[k] * \delta[k] - \left(\frac{1}{e}\right)^k u[k] * \frac{1}{2} (-2)^k u[k] \\ &= \frac{1}{2} e^{-k} u[k] - \frac{(1/e)^{k+1} - (-2)^{k+1}}{2[(1/e)+2]} u[k] \\ &= \left\{ \frac{1}{2} e^{-k} - \frac{e}{2(2e+1)} [e^{-(k+1)} - (-2)^{k+1}] \right\} u[k] \end{aligned}$$

9.4-3

$$\begin{aligned} y[k] &= (3)^{k+2} u[k] * [(2)^k + 3(-5)^k] u[k] \\ &= 9[(3)^k u[k] * (2)^k u[k] + 3(3)^k u[k] * (-5)^k u[k]] \\ &= 9 \left[ \frac{(3)^{k+1} - (2)^{k+1}}{3-2} + 3 \frac{(3)^{k+1} - (-5)^{k+1}}{3+5} \right] u[k] \\ &= 9 \left[ \frac{11}{8} (3)^{k+1} - (2)^{k+1} - \frac{3}{8} (-5)^{k+1} \right] u[k] \end{aligned}$$

9.4-4

$$\begin{aligned} y[k] &= (3)^{-k} u[k] * 3k(2)^k u[k] \\ &= 3 \left(\frac{1}{3}\right)^k u[k] * k(2)^k u[k] \\ &= 3 \frac{2/3}{(2-1/3)^2} \left[ \left(\frac{1}{3}\right)^k - (2)^k + \left(\frac{2-1/3}{1/3}\right) k(2)^k \right] u[k] \\ &= \frac{18}{25} [(3)^{-k} - (2)^k + 5k(2)^k] u[k] \end{aligned}$$

9.4-5

$$\begin{aligned} y[k] &= (3)^k \cos\left(\frac{\pi}{3}k - 0.5\right) u[k] * (2)^k u[k] \\ R &= [(3)^2 + (2)^2 - 2(3)(2)(0.5)]^{1/2} = \sqrt{7} \\ \phi &= \tan^{-1} \left[ \frac{3\sqrt{3}/2}{1.5-2} \right] = 1.761 \text{ rad} \end{aligned}$$

and

$$\begin{aligned} y[k] &= \frac{1}{\sqrt{7}} \{ (3)^{k+1} \cos[\frac{\pi}{3}(k+1) - 2.261] - (2)^{k+1} \cos(2.261) \} u[k] \\ &= \frac{1}{\sqrt{7}} \{ (3)^{k+1} \cos[\frac{\pi}{3}(k+1) - 2.261] + 0.637(2)^{k+1} \} u[k] \end{aligned}$$

9.4-6 the characteristic root is  $-2$ . Therefore

$$y_0[k] = c(-2)^k$$

Setting  $k = -1$  and substituting  $y[-1] = 10$ , yields

$$10 = -\frac{c}{2} \implies c = -20$$

Therefore

$$y_0[k] = -20(-2)^k \quad k \geq 0$$

For this system  $h[k]$ , the unit impulse response is found in Prob. 9.3-2 to be

$$h[k] = (-2)^k u[k]$$

The zero-state response is

$$y[k] = e^{-k}u[k] * (-2)^k u[k]$$

This is found in Prob. 9.4-1 to be

$$\begin{aligned} y[k] &= \frac{e}{2e+1} [e^{-(k+1)} - (-2)^{k+1}] u[k] \\ &= \frac{e}{2e+1} \left[ \frac{1}{e} (e)^{-k} + 2(-2)^k \right] u[k] \\ &= \left[ \frac{1}{2e+1} (e)^{-k} + \frac{2e}{2e+1} (-2)^k \right] u[k] \end{aligned}$$

$$\begin{aligned} \text{Total Response} &= y_0[k] + y[k] \\ &= [-20(-2)^k + \frac{1}{2e+1} (e)^{-k} + \frac{2e}{2e+1} (-2)^k] u[k] \\ &= \frac{1}{2e+1} [-(38e + 20)(-2)^k + (e)^{-k}] u[k] \end{aligned}$$

9.4-7 (a)

$$\begin{aligned} y[k] &= 2^k u[k] * (0.5)^k u[k] \\ &= \frac{2^{k+1} - (0.5)^{k+1}}{2 - 0.5} u[k] = \frac{2}{3} [2^{k+1} - (0.5)^{k+1}] u[k] \end{aligned}$$

(b)

$$f[k] = 2^{(k-3)} u[k] = 2^{-3} 2^k u[k] = \frac{1}{8} 2^k u[k]$$

From the result in part (a), it follows that

$$y[k] = \frac{1}{8} \frac{2}{3} [2^{k+1} - (0.5)^{k+1}] u[k] = \frac{1}{12} [2^{k+1} - (0.5)^{k+1}] u[k]$$

(c)

$$f[k] = 2^k u[k-2] = 4 \{ 2^{(k-2)} u[k-2] \}$$

Note that  $2^{(k-2)} u[k-2]$  is the same as the input  $2^k u[k]$  in part (a) delayed by 2 units. Therefore from the shift property of the convolution, its response will be the same as in part (a) delayed by 2 units. The input here is  $4 \{ 2^{(k-2)} u[k-2] \}$ . Therefore

$$y[k] = 4 \frac{2}{3} [2^{k+1-2} - (0.5)^{k+1-2}] u[k-2] = \frac{8}{3} [2^{k-1} - (0.5)^{k-1}] u[k-2]$$

9.4-8 The equation describing this situation is [see Eq. (8.20b)]

$$(E - a)y[k] = Ef[k] \quad a = 1 + r = 1.01$$

The initial condition  $y[-1] = 0$ . Hence there is only zero-state component. The input is  $500u[k] - 1500\delta[k-4]$  because at  $k = 4$ , instead of depositing the usual \$500, she withdraws \$1000.

To find  $h[k]$ , we solve iteratively

$$(E - a)h[k] = E\delta[k]$$

or

$$h[k+1] - ah[k] = \delta[k+1]$$

Setting  $k = -1$  and substituting  $h[-1] = 0$ ,  $\delta[0] = 1$ , yields

$$h[0] = 1$$

Also, the characteristic root is  $a$  and  $b_0 = 0$ . Therefore

$$h[k] = ca^k u[k]$$

Setting  $k = 0$  and substituting  $h[0] = 1$  yields

$$1 = c$$

Therefore

$$h[k] = (a)^k u[k] = (1.01)^k u[k]$$



The (zero-state) response is

$$\begin{aligned}
 y[k] &= (1.01)^k u[k] * f[k] \\
 &= (1.01)^k u[k] * \{500u[k] - 1500\delta[k-4]\} \\
 &= 500(1.01)^k u[k] * u[k] - 1500(1.01)^{k-4} u[k-4] \\
 &= \frac{500}{0.01} [(1.01)^{k+1} - 1] u[k] - 1500(1.01)^{k-4} u[k-4] \\
 &= 50000[(1.01)^{k+1} - 1] u[k] - 1500(1.01)^{k-4} u[k-4]
 \end{aligned}$$

**9.4-9** This problem is identical to the savings account problem with negative initial deposit (loan). If  $M$  is the initial loan, then  $y[0] = -M$ . If  $y[k]$  is the loan balance, then [see Eq. (8.25b)]

$$y[k+1] - ay[k] = f[k+1] \quad a = 1 + r$$

or

$$(E - a)y[k] = Ef[k]$$

The characteristic root is  $a$ , and the impulse response for this system is found in Prob. 9.4-8 to be

$$h[k] = a^k u[k]$$

This problem can be solved in two ways.

**First method:** We may consider the loan of  $M$  dollars as an a negative input  $-M\delta[k]$ . The monthly payment of  $P$  starting at  $k = 1$  also is an input. Thus the total input is  $f[k] = -M\delta[k] + Pu[k-1]$  with zero initial conditions. Because  $u[k] = \delta[k] + u[k-1]$ , we can express the input in a more convenient form as  $f[k] = -(M+P)\delta[k] + Pu[k]$ . The loan balance (response)  $y[k]$  is

$$\begin{aligned}
 y[k] &= h[k] * f[k] \\
 &= a^k u[k] * \{-(M+P)\delta[k] + Pu[k]\} \\
 &= -(M+P)a^k u[k] + Pa^k u[k] * u[k] \\
 &= -(M+P)a^k u[k] + P \left[ \frac{a^{k+1} - 1}{a - 1} \right] u[k] \\
 &= -Ma^k u[k] - P \left[ a^k - \frac{a^{k+1} - 1}{a - 1} \right] u[k] \\
 &= \left\{ -Ma^k + P \left[ \frac{a^k - 1}{a - 1} \right] \right\} u[k]
 \end{aligned}$$

Also  $a = 1 + r$  and  $a - 1 = r$  where  $r$  is the interest rate per dollar per month. At  $k = N$ , the loan balance is zero. Therefore

$$y[N] = -Ma^N + P \left[ \frac{a^N - 1}{r} \right] = 0$$

or

$$P = \frac{ra^N}{a^N - 1} M$$

**Second method:** In this approach, the initial condition is  $y[0] = -M$ , and the input is  $f[k] = Pu[k-1]$  because the monthly payment of  $P$  starts at  $k = 1$ . The characteristic root is  $a$ , and The zero-input response is

$$y_0[k] = ca^k u[k]$$

Setting  $k = 0$ , and substituting  $y_0[0] = -M$ , yields  $c = -M$  and

$$y_0[k] = -Ma^k u[k]$$

The zero-state response  $y[k]$  is

$$y[k] = h[k] * f[k] = h[k] * Pu[k-1] = Pa^k u[k] * u[k-1]$$

Here we use shift property of convolution. If we let

$$x[k] = a^k u[k] * u[k] = \left[ \frac{a^{k+1} - 1}{a - 1} \right] u[k]$$

The shift property yields

$$Pa^k u[k] * u[k-1] = x[k-1] = P \left[ \frac{a^k - 1}{a - 1} \right] u[k-1]$$

The total balance is  $y_0[k] + y[k]$

$$y_0[k] + y[k] = -Ma^k u[k] + P \left[ \frac{a^k - 1}{a - 1} \right] u[k-1]$$

For  $k > 1$ ,  $u[k] = u[k-1] = 1$ . Therefore

$$\text{Loan balance} = -Ma^k + P \left[ \frac{a^k - 1}{a - 1} \right] \quad k > 1$$

which confirms the result obtained by the first method. From here on the procedure is identical to that of the first method.

9.4-10 We use the result in Prob. 9.4-9. In this problem  $r = 0.015$ ,  $a = 1.015$ ,  $P = 500$ ,  $M = 10000$ . Therefore

$$\begin{aligned} \text{or} \quad 500 &= 10000 \frac{(1.015)^N (0.015)}{(1.015)^N - 1} \\ (1.015)^N &= 1.42857 \\ N \ln(1.015) &= \ln(1.42857) \\ N &= \frac{\ln(1.42857)}{\ln(1.015)} = 23.956 \end{aligned}$$

Hence  $N = 23$  payments are needed. The residual balance (remainder) at the 23rd payment is

$$y[23] = -10000(1.015)^{23} + 500 \left[ \frac{(1.015)^{23} - 1}{0.015} \right] = -471.2$$

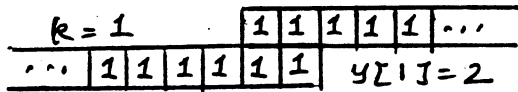
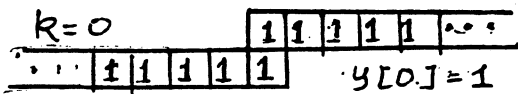

(a)

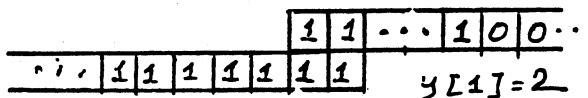
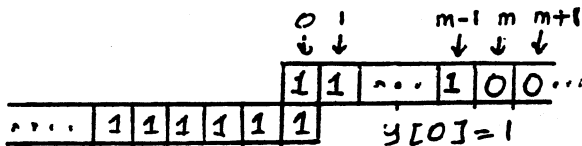
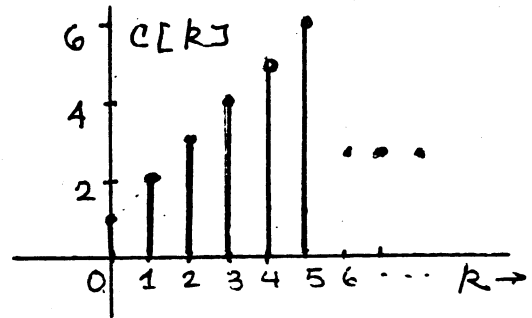

(b)

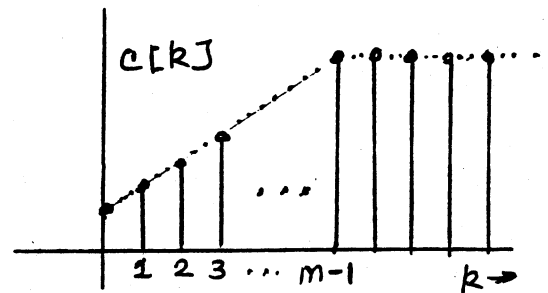

Fig. S9.4-11

9.4-11 (a) The two strips corresponding to  $u[k]$  and  $u[k]$  (after inversion) are shown in the figure S9.4-11a for no shift ( $k = 0$ ) and for one shift ( $k = 1$ ). We see that if  $c[k] = u[k] * u[k]$  then

$$c[0] = 1, \quad c[1] = 2, \quad c[2] = 3, \quad c[3] = 4, \quad c[4] = 5, \quad c[5] = 6, \dots, \quad c[k] = k + 1$$

Hence

$$u[k] * u[k] = (k + 1)u[k]$$

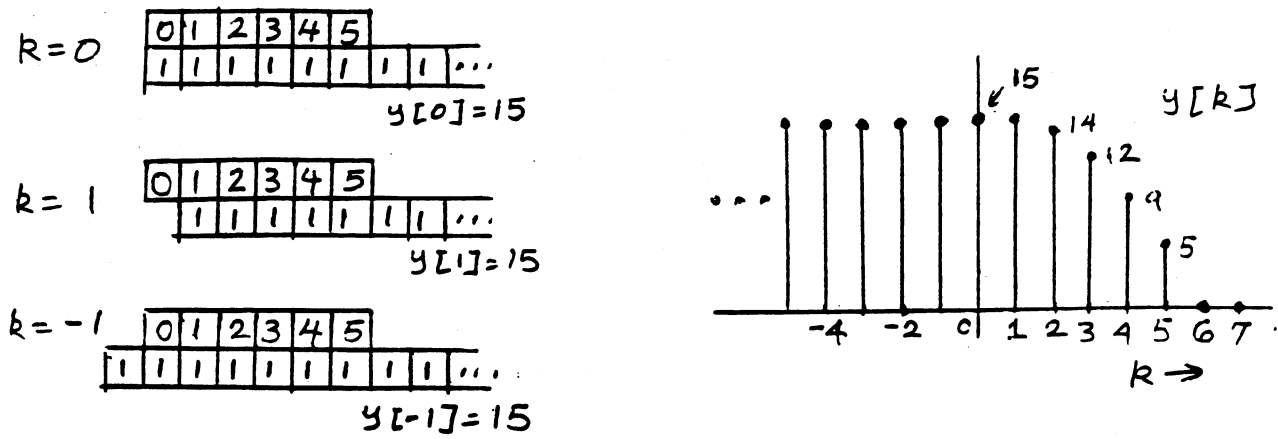

Fig. S9.4-12

(b) The appropriate strips for the two functions  $u[k] - u[k - m]$  and  $u[k]$  are shown in Fig. S9.4-11b. The upper strip corresponding to  $u[k] - u[k - m]$  has first  $m$  slots with value 1 and all the remaining slots have value 0. The lower (inverted) strip corresponding to  $u[k]$  has all slot values of 1. From this figure it follows that

$$c[0] = 1, \quad c[1] = 2, \quad c[2] = 3, \dots, c[m-1] = m$$

$$c[m] = c[m+1] = \dots = m$$

$$\text{Hence } c[k] = (k+1)u[k] - (k-m+1)u[k-m]$$

9.4-12 From Fig. S9.4-12 we observe that

$k$	$y[k]$	
0	$0 + 1 + 2 + 3 + 4 + 5 = 15$	$y[k] = 0 \quad k \geq 6$
1	$1 + 2 + 3 + 4 + 5 = 15$	
2	$2 + 3 + 4 + 5 = 14$	$y[k] = 15 \quad k < 0$
3	$3 + 4 + 5 = 12$	
4	$4 + 5 = 9$	
5	5	
6	0	

9.4-13 From Fig. S9.4-13, we observe the following values for  $y[k]$ :

$k$	$y[k]$	$k$	$y[k]$
0	$5 \times 5 + 5 \times 5 = 50$	$\pm 11$	$0 \times 0 + 5 \times 4 = 20$
$\pm 1$	$5 \times 4 + 0 = 20$	$\pm 12$	$0 \times 0 + 5 \times 3 = 15$
$\pm 2$	$5 \times 3 + 0 = 15$	$\pm 13$	$0 \times 0 + 5 \times 2 = 10$
$\pm 3$	$5 \times 2 + 0 = 10$	$\pm 14$	$0 \times 0 + 5 \times 1 = 5$
$\pm 4$	$5 \times 1 + 0 = 5$	$\pm 15$	$0 \times 0 + 0 \times 0 = 0$
$\pm 5$	$5 \times 0 + 0 = 0$	$\pm 16$	0
...	...	$\pm 17$	0
$\pm 9$	$0 \times 0 + 0 \times 0 = 0$	$\pm 18$	0
$\pm 10$	$0 \times 0 + 5 \times 1 = 5$		

Observe that

$$y[k] = 0 \quad 5 \leq |k| \leq 9 \quad \text{and} \quad |k| \geq 15$$

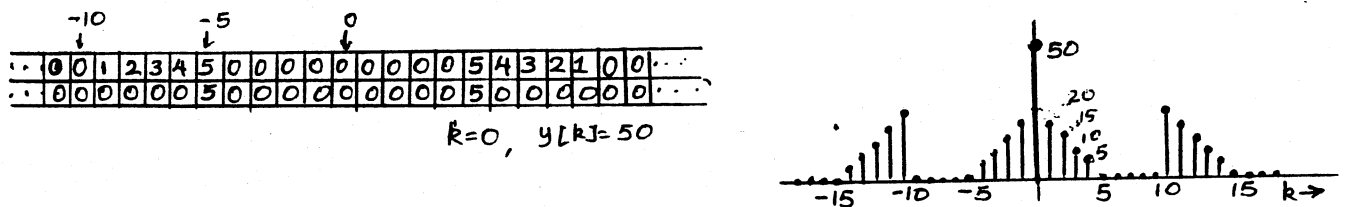

Fig. S9.4-13

9.4-14 (a) From Fig. S9.4-13, we observe the following values of  $y[k]$ :

$k$	0	$\pm 1$	$\pm 2$	$\pm 3$	$\pm 4$	$\pm 5$	$\pm 6$	$\pm 7$	$ k  > 7$
$y[k]$	7	6	5	4	3	2	1	0	0

(b) The answer is identical to that of (a). This is because when we lay the tapes  $f[m]$  and  $g[-m]$  together, the situation is identical to that in (a).

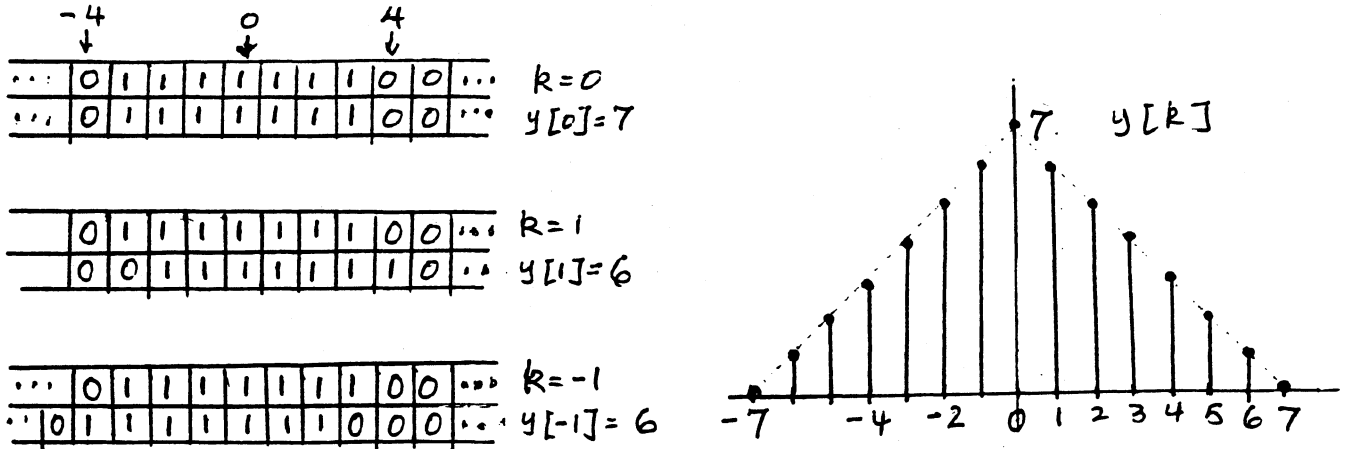

Fig. S9.4-14

9.4.15. (a)

$$\begin{aligned}
 8 &= h[0] \\
 12 &= h[1] + h[0] \Rightarrow h[1] = 12 - 8 = 4 \\
 14 &= h[2] + h[1] + h[0] \Rightarrow h[2] = 2 \\
 15 &= h[3] + h[2] + h[1] + h[0] \Rightarrow h[3] = 1 \\
 15.5 &= h[4] + h[3] + h[2] + h[1] + h[0] \Rightarrow h[4] = 0.5 \\
 15.75 &= h[5] + h[4] + h[3] + h[2] + h[1] + h[0] \Rightarrow h[5] = 0.25
 \end{aligned}$$

(b)

$$\mathbf{H} = \begin{bmatrix} 1 & 0 & 0 \\ 2 & 1 & 0 \\ 4 & 2 & 1 \end{bmatrix} \Rightarrow \mathbf{H}^{-1} = \begin{bmatrix} 1 & 0 & 0 \\ -2 & 1 & 0 \\ 0 & -2 & 1 \end{bmatrix}$$

$$\mathbf{f} = \mathbf{H}^{-1} \mathbf{y} = \begin{bmatrix} 1 & 0 & 0 \\ -2 & 1 & 0 \\ 0 & -2 & 1 \end{bmatrix} \begin{bmatrix} 1 \\ 7/3 \\ 43/9 \end{bmatrix} = \begin{bmatrix} 1 \\ 1/3 \\ 1/9 \end{bmatrix}$$

Hence the input sequence is:  $(1, 1/3, 1/9, \dots)$

9.4-16

9.4-17 When the input to a unit delay is everlasting exponential  $z^k$ , the output is also everlasting exponential  $z^{k-1}$ . Hence, according to Eq. (9.58)  $H[z] = z^{k-1}/z^k = 1/z$ .

9.5-1

$$(E + 2)y[k] = E f[k]$$

The characteristic equation is  $\gamma + 2 = 0$ , and the characteristic root is  $-2$ . Therefore

$$y_n(t) = B(-2)^k$$

For  $f[k] = e^{-k}u[k] = r^k$  with  $r = e^{-1}$

$$\begin{aligned}
 y_\phi[k] &= H[e^{-1}]e^{-k} = \frac{e^{-1}}{e^{-1}+2}e^{-k} = \frac{1}{2e+1}e^{-k} \\
 y[k] &= B(-2)^k + \frac{1}{2e+1}e^{-k} \quad k \geq 0
 \end{aligned}$$

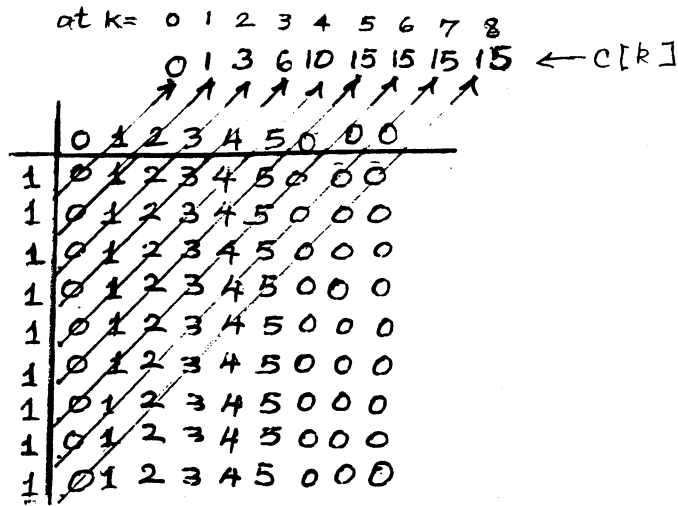

Fig. S9.4-16

Setting  $k = 0$ , and substituting  $y[0] = 1$  yields

$$1 = B + \frac{1}{2e+1} \implies B = \frac{2e}{2e+1}$$

and

$$y[k] = \frac{1}{2e+1} [2e(-2)^k + e^{-k}] \quad k \geq 0$$

9.5-2

$$y[k] + 2y[k-1] = f[k-1] \quad (1)$$

We solve this equation iteratively to obtain  $y[0]$ . Setting  $k = 0$ , and substituting  $y[-1] = 0$ ,  $f[-1] = 0$ , we get

$$y[0] + 2(0) = 0 \implies y[0] = 0$$

The system equation can be expressed as

$$(E + 2)y[k] = f[k]$$

The characteristic root is  $-2$ . Therefore

$$y_n[k] = B(-2)^k$$

For  $f[k] = e^{-k}u[k] = r^k u[k]$  with  $r = e^{-1}$ ,

$$y_\phi[k] = H[r]r^k = H[e^{-1}]e^{-k} = \frac{1}{e^{-1}+2}e^{-k} = \frac{e}{2e+1}e^{-k}$$

Therefore

$$y[k] = B(-2)^k + \frac{e}{2e+1}e^{-k} \quad k \geq 0$$

Setting  $k = 0$  and substituting  $y[0] = 0$  yields

$$0 = B + \frac{e}{2e+1} \implies B = \frac{-e}{2e+1}$$

and

$$y[k] = \frac{e}{2e+1} [ -(-2)^k + e^{-k} ] \quad k \geq 0$$

9.5-3

$$(E^2 + 3E + 2)y[k] = (E^2 + 3E + 3)f[k]$$

The characteristic equation is  $\gamma^2 + 3\gamma + 2 = (\gamma + 1)(\gamma + 2) = 0$ . Therefore

$$y_n[k] = B_1(-1)^k + B_2(-2)^k$$

For  $f[k] = 3^k$

$$y_\phi[k] = H[3]3^k = \frac{(3)^2 + 3(3) + 3}{(3)^2 + 3(3) + 2} 3^k = \left(\frac{21}{20}\right)3^k$$

The total response

$$y[k] = B_1(-1)^k + B_2(-2)^k + \left(\frac{21}{20}\right)3^k \quad k \geq 0$$

(a) Setting  $k = 0, 1$ , and substituting  $y[0] = 1, y[1] = 3$ , yields

$$\left. \begin{aligned} 1 &= B_1 + B_2 + \frac{21}{20} \\ 3 &= -B_1 - 2B_2 + \frac{63}{20} \end{aligned} \right\} \implies \begin{aligned} B_1 &= -\frac{1}{4} \\ B_2 &= \frac{1}{5} \end{aligned}$$

$$y[k] = -\frac{1}{4}(-1)^k + \frac{1}{5}(-2)^k + \frac{21}{20}(3)^k \quad k \geq 0$$

(b) We solve system equation iteratively to find  $y[0]$  and  $y[1]$ . We are given  $y[-1] = y[-2] = 1$ . System equation is

$$y[k+2] + 3y[k+1] + 2y[k] = f[k+2] + 3f[k+1] + 3f[k]$$

Setting  $k = -2$ , we obtain

$$y[0] + 3(1) + 2(1) = (3)^0 + 3(0) + 3(0) \implies y[0] = -4$$

Setting  $k = -1$ , we obtain

$$y[1] + 3[-4] + 2(1) = (3)^1 + 3(3)^0 + 3(0) \implies y[1] = 16$$

Also

$$y[k] = B_1(-1)^k + B_2(-2)^k + \frac{21}{20}(3)^k \quad k \geq 0$$

Setting  $k = 1, 2$ , and substituting  $y[0] = -4, y[1] = 16$ , yields

$$\left. \begin{aligned} -4 &= B_1 + B_2 + \frac{21}{20} \\ 16 &= -B_1 - 2B_2 + \frac{63}{20} \end{aligned} \right\} \implies \begin{aligned} B_1 &= \frac{11}{4} \\ B_2 &= -\frac{39}{5} \end{aligned}$$

and

$$y[k] = \frac{11}{4}(-1)^k - \frac{39}{5}(-2)^k + \frac{21}{20}(3)^k \quad k \geq 0$$

9.5-4

$$\gamma^2 + 2\gamma + 1 = (\gamma + 1)^2 = 0$$

The roots are  $-1$  repeated twice.

$$y_n[k] = (B_1 + B_2k)(-1)^k$$

Also the system equation is  $(E^2 + 2E + 1)y[k] = (2E^2 - E)f[k]$ , and  $f[k] = \left(\frac{1}{3}\right)^k$ . Therefore

$$y_\phi[k] = H\left[\frac{1}{3}\right]3^{-k} = -\frac{1}{16}(3)^{-k} \quad k \geq 0$$

The total response

$$y[k] = (B_1 + B_2k)(-1)^k - \frac{1}{16}(3)^{-k} \quad k \geq 0$$

Setting  $k = 0, 1$ , and substituting  $y[0] = 2, y[1] = -\frac{13}{3}$ , yields

$$\left. \begin{aligned} 2 &= B_1 - \frac{1}{16} \\ -\frac{13}{3} &= -(B_1 + B_2) - \frac{1}{48} \end{aligned} \right\} \implies \begin{aligned} B_1 &= \frac{33}{16} \\ B_2 &= \frac{9}{4} \end{aligned}$$

$$y[k] = \left(\frac{33}{16} + \frac{9}{4}k\right)(-1)^k - \frac{1}{16}(3)^{-k} \quad k \geq 0$$

9.5-5

$$\gamma^2 - \gamma + 0.16 = (\gamma - 0.2)(\gamma - 0.8)$$

The roots are 0.2 and 0.8.

$$y_n[k] = B_1(0.2)^k + B_2(0.8)^k$$

Because the input is a mode

$$y_\phi[k] = ck(0.2)^k$$

But  $y_\phi[k]$  satisfies the system equation, that is,

$$y_\phi[k+2] - y_\phi[k+1] + 0.16y_\phi[k] = f[k+1]$$

and

$$c(k+2)(0.2)^{k+2} - c(k+1)(0.2)^{k+1} + 0.16ck(0.2)^k = (0.2)^{k+1}$$

This yields

$$-0.12c(0.2)^k = 0.2(0.2)^k$$

Therefore

$$c = -\frac{5}{3}$$

and

$$\begin{aligned} y_\phi[k] &= -\frac{5}{3}k(0.2)^k \\ y[k] &= B_1(0.2)^k + B_2(0.8)^k - \frac{5}{3}k(0.2)^k \quad k \geq 0 \end{aligned}$$

Setting  $k = 0, 1$ , and substituting initial conditions  $y[0] = 1, y[1] = 2$ , yields

$$\left. \begin{aligned} 1 &= B_1 + B_2 \\ 2 &= 0.2B_1 + 0.8B_2 - \frac{1}{3} \end{aligned} \right\} \Rightarrow \begin{aligned} B_1 &= -\frac{23}{9} \\ B_2 &= \frac{32}{9} \end{aligned}$$

$$y[k] = -\frac{23}{9}(0.2)^k + \frac{32}{9}(0.8)^k - \frac{5}{3}k(0.2)^k \quad k \geq 0$$

#### 9.5-6

$$y[k+2] - y[k+1] + 0.16y[k] = f[k+1]$$

We solve this equation iteratively for  $f[k] = \cos(\frac{\pi k}{2} + \frac{\pi}{3})$ ,  $y[-1] = y[-2] = 0$ , to find  $y[0]$  and  $y[1]$ . Remember also that  $f[k] = 0$  for  $k < 0$ .

Setting  $k = -2$  in the equation yields

$$y[0] - 0 + 0.16(0) = 0 \quad \Rightarrow \quad y[0] = 0$$

Setting  $k = -1$  in the equation yields

$$y[1] - 0 + 0.16(0) = \cos \frac{\pi}{3} = 0.5 \quad \Rightarrow \quad y[1] = 0.5$$

Therefore  $y[0] = 0$  and  $y[1] = 0.5$ . For the input  $f[k] = \cos(\frac{\pi k}{2} + \frac{\pi}{3})$ .

$$y_\phi[k] = c \cos(\frac{\pi k}{2} + \frac{\pi}{3} + \phi)$$

But  $y_\phi[k]$  satisfies the system equation, that is,

$$y_\phi[k+2] - y_\phi[k+1] + 0.16y_\phi[k] = f[k+1]$$

or

$$c \cos[\frac{\pi}{2}(k+2) + \frac{\pi}{3} + \phi] - c \cos[\frac{\pi}{2}(k+1) + \frac{\pi}{3} + \phi] + 0.16c \cos(\frac{\pi k}{2} + \frac{\pi}{3} + \phi) = \cos[\frac{\pi}{2}(k+1) + \frac{\pi}{3}]$$

or

$$-c \cos(\frac{\pi k}{2} + \frac{\pi}{3} + \phi) + c \sin(\frac{\pi k}{2} + \frac{\pi}{3} + \phi) + 0.16c \cos(\frac{\pi k}{2} + \frac{\pi}{3} + \phi) = \cos(\frac{\pi k}{2} + \frac{\pi}{3} + \frac{\pi}{2})$$

or

$$1.306c \cos(\frac{\pi k}{2} + \frac{\pi}{3} + \phi - 2.27) = \cos(\frac{\pi k}{2} + \frac{\pi}{3} + \frac{\pi}{2})$$

Therefore

$$\begin{aligned} 1.306c &= 1 \quad \Rightarrow \quad c = 0.765 \\ \phi - 2.27 &= \frac{\pi}{2} \quad \Rightarrow \quad \phi = 3.84 = -2.44\text{rad} \end{aligned}$$

Therefore

$$\begin{aligned} y_\phi[k] &= 0.765 \cos\left(\frac{\pi k}{2} + \frac{\pi}{3} - 2.44\right) \\ &= 0.765 \cos\left(\frac{\pi k}{2} - 1.393\right) \end{aligned}$$

$$y[k] = B_1(0.2)^k + B_2(0.8)^k + 0.765 \cos\left(\frac{\pi k}{2} - 1.393\right)$$

Setting  $k = 0, 1$ , and substituting  $y[0] = 0, y[1] = 0.5$ , yields

$$\left. \begin{aligned} 0 &= B_1 + B_2 + 0.1354 \\ 0.5 &= 0.2B_1 + 0.8B_2 + 0.753 \end{aligned} \right\} \Rightarrow \begin{aligned} B_1 &= 0.241 \\ B_2 &= -0.377 \end{aligned}$$

$$y[k] = 0.241(0.2)^k - 0.377(0.8)^k + 0.765 \cos\left(\frac{\pi k}{2} - 1.393\right)$$

9.6-1 (a)

$$\gamma^2 + 0.6\gamma - 1.6 = (\gamma - 0.2)(\gamma + 0.8)$$

Roots are 0.2 and  $-0.8$ . Both are inside the unit circle. The system is asymptotically stable.

(b)

$$(\gamma^2 + 1)(\gamma^2 + \gamma + 1) = (\gamma - j1)(\gamma + j1)\left(\gamma + \frac{1}{2} - \frac{j\sqrt{3}}{2}\right)\left(\gamma + \frac{1}{2} + \frac{j\sqrt{3}}{2}\right)$$

Roots are  $\pm j1, -\frac{1}{2} \pm \frac{j\sqrt{3}}{2} = e^{\pm j\pi/3}$ .

All the roots are simple and on unit circle. The system is marginally stable.

(c)

$$(\gamma - 1)^2\left(\gamma + \frac{1}{2}\right)$$

Roots are 1 (repeated twice) and  $-0.5$ . Repeated root on unit circle. The system is unstable.

(d)

$$\gamma^2 + 2\gamma + 0.96 = (\gamma + 0.8)(\gamma + 1.2)$$

Roots are  $-0.8$  and  $-1.2$ . One root ( $-1.2$ ) is outside the the unit circle. The system is unstable.

(e)

$$(\gamma^2 - 1)(\gamma^2 + 1) = (\gamma + 1)(\gamma - 1)(\gamma + j1)(\gamma - j1)$$

Roots are  $\pm 1, \pm j1$ . All the roots are simple and on unit circle. The system is marginally stable.

9.6-2 Assume that a system exists that violates (9.61), and yet produces bounded output for every bounded input. The system response at  $k = k_1$  is

$$y[k_1] = \sum_{m=0}^{\infty} h[m]f[k_1 - m]$$

Consider a bounded input  $f[k]$  such that

$$f[k_1 - m] = \begin{cases} 1 & \text{if } h[m] > 0 \\ -1 & \text{if } h[m] < 0 \end{cases}$$

In this case

$$h[m]f[k_1 - m] = |h[m]|$$

and

$$y[k_1] = \sum_{m=0}^{\infty} |h[m]| = \infty$$

This violates the assumption.

9.6-3 For a marginally stable system  $h[k]$  does not decay. For large  $k$ , it is either constant or oscillates with constant amplitude. Clearly

$$\sum_{m=0}^{\infty} |h[m]| = \infty$$

The system is BIBO unstable.



# Chapter 10



Fig. S10.1-1

10.1-1

$$\begin{aligned}
 f[k] &= 4 \cos 2.4\pi k + 2 \sin 3.2\pi k \\
 &= 4 \cos 0.4\pi k + 2 \sin 1.2\pi k \\
 &= 2[e^{j0.4\pi k} + e^{-j0.4\pi k}] + \frac{1}{j}[e^{j1.2\pi k} - e^{-j1.2\pi k}] \\
 &= 2e^{j0.4\pi k} + 2e^{-j0.4\pi k} + e^{j(1.2\pi k - \pi/2)} + e^{-j(1.2\pi k - \pi/2)}
 \end{aligned}$$

The fundamental  $\Omega_0 = 0.4\pi$  and  $N_0 = \frac{2\pi}{\Omega_0} = 5$ . Note also that.

$$e^{-j0.4\pi k} = e^{j1.6\pi k} \quad \text{and} \quad e^{-j1.2\pi k} = e^{j0.8\pi k}$$

Therefore

$$f[k] = 2e^{j0.4\pi k} + 2e^{j1.6\pi k} + e^{j(1.2\pi k - \pi/2)} + e^{j(0.8\pi k + \pi/2)}$$

We have first, second, third and fourth harmonics with coefficients

$$\begin{aligned}
 D_1 &= D_2 = 2 \quad D_3 = -j \quad D_4 = j \\
 |D_1| &= |D_2| = 2 \quad |D_3| = |D_4| = 1 \\
 \angle D_1 &= \angle D_2 = 0 \quad \angle D_3 = -\frac{\pi}{2} \quad \text{and} \quad \angle D_4 = \frac{\pi}{2}
 \end{aligned}$$

The spectrum is shown in Fig. S10.1-1.



Fig. S10.1-2

10.1-2

$$\begin{aligned}
 f[k] &= \cos 2.2\pi k \cos 3.3\pi k = \frac{1}{2}[\cos 5.5\pi k + \cos 1.1\pi k] \\
 &= \frac{1}{2}[\cos 1.5\pi k + \cos 1.1\pi k] \\
 &= \frac{1}{2}[e^{j1.5\pi k} + e^{-j1.5\pi k} + e^{j1.1\pi k} + e^{-j1.1\pi k}] \\
 &= \frac{1}{2}[e^{j1.5\pi k} + e^{j0.5\pi k} + e^{j1.1\pi k} + e^{j0.9\pi k}]
 \end{aligned}$$

The fundamental frequency  $\Omega_0 = 0.1$  and  $N_0 = \frac{2\pi}{\Omega_0} = 20$ . There are only 5th, 9th, 11th and 15th harmonics with coefficients

$$D_5 = D_9 = D_{11} = D_{15} = \frac{1}{2}$$

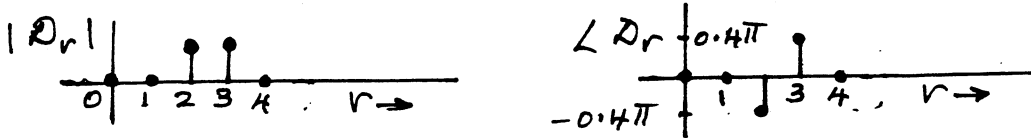

Fig. S10.1-3

All the coefficients are real (phases zero). The spectrum is shown in Fig. S10.1-2.

10.1-3

$$\begin{aligned}
 f[k] &= 2 \cos 3.2\pi(k-3) = 2 \cos(3.2\pi k - 9.6\pi) = 2 \cos(1.2\pi k + 0.4\pi) \\
 &= e^{j(1.2\pi k + 0.4\pi)} + e^{-j(1.2\pi k + 0.4\pi)} \\
 &= e^{j(1.2\pi k + 0.4\pi)} + e^{j(0.8\pi k - 0.4\pi)}
 \end{aligned}$$

The fundamental frequency  $\Omega_0 = 0.4\pi$  and  $N_0 = \frac{2\pi}{\Omega_0} = 5$ . Only 2nd, and 3rd harmonics are present.

$$|D_2| = |D_3| = 1 \quad \angle D_2 = -0.4\pi \quad \angle D_3 = -9.6\pi = 0.4\pi$$

The spectrum is shown in Fig. S10.1-3.

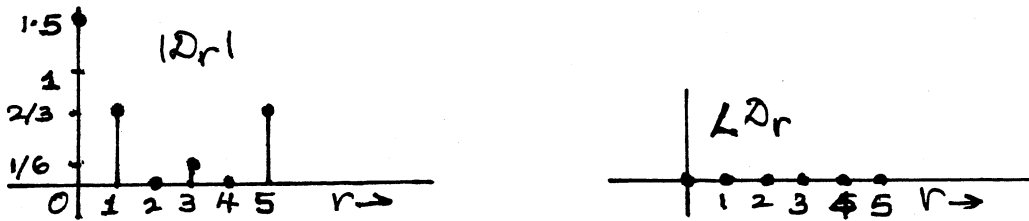

Fig. S10.1-4

10.1-4 To compute coefficients  $D_r$ , we use Eq. (10.13) where summation is performed over any interval  $N_0$ . We choose this interval to be  $-N_0/2, (N_0/2) - 1$  (for even  $N_0$ ). Therefore

$$D_r = \frac{1}{N_0} \sum_{k=-N_0/2}^{(N_0/2)-1} f[k] e^{-jr\Omega_0 k}$$

In the present case  $N_0 = 6$ ,  $\Omega_0 = \frac{2\pi}{N_0} = \frac{\pi}{3}$ , and

$$D_r = \frac{1}{6} \sum_{k=-3}^2 f[k] e^{-jr\frac{\pi}{3}k}$$

We have  $f[0] = 3$ ,  $f[\pm 1] = 2$ ,  $f[\pm 2] = 1$ , and  $f[\pm 3] = 0$ . Therefore

$$\begin{aligned}
 D_r &= \frac{1}{6} [3 + 2(e^{j\frac{\pi}{3}r} + e^{-j\frac{\pi}{3}r}) + (e^{j\frac{2\pi}{3}r} + e^{-j\frac{2\pi}{3}r})] \\
 &= \frac{1}{6} [3 + 4 \cos(\frac{\pi}{3}r) + 2 \cos(\frac{2\pi}{3}r)]
 \end{aligned}$$

$$D_0 = \frac{3}{2} \quad D_1 = \frac{2}{3} \quad D_2 = 0 \quad D_3 = \frac{1}{6} \quad D_4 = 0 \quad D_5 = \frac{2}{3}$$

Here, the spectrum is real. Hence,  $|D_r| = D_r$  and  $\angle D_r = 0$ .

10.1-5 In this case  $N_0 = 12$  and  $\Omega_0 = \frac{\pi}{6}$ .

$$\begin{aligned}
 f[0] &= 0 & f[1] &= 1 & f[-1] &= -1 & f[2] &= 2 & f[-2] &= -2 \\
 f[3] &= 3 & f[-3] &= -3 & f[\pm 4] &= f[\pm 5] = f[\pm 6] &= 0
 \end{aligned}$$

Therefore

$$\begin{aligned}
D_r &= \frac{1}{12} \sum_{k=-6}^5 f[k] e^{-jr \frac{\pi}{6} k} \\
&= \frac{1}{12} [e^{-j \frac{\pi}{6} r} - e^{j \frac{\pi}{6} r} + 2(e^{-j \frac{2\pi}{6} r} - e^{j \frac{2\pi}{6} r}) + 3(e^{-j \frac{3\pi}{6} r} - e^{j \frac{3\pi}{6} r})] \\
&= \frac{-j}{12} [2 \sin(\frac{\pi}{6} r) + 4 \sin(\frac{\pi}{3} r) + 6 \sin(\frac{\pi}{2} r)]
\end{aligned}$$

Here, the spectrum is imaginary. Hence,  $|D_r| = \frac{1}{12} |2 \sin(\frac{\pi}{6} r) + 4 \sin(\frac{\pi}{3} r) + 6 \sin(\frac{\pi}{2} r)|$  and  $\angle D_r = -\frac{\pi}{2}$ .

**10.1-6** Here, the period is  $N_0$  and  $\Omega_0 = 2\pi/N_0$ . Using Eq. (10.9), we obtain

$$D_r = \frac{1}{N_0} \sum_{k=0}^{N_0-1} a^k e^{-jr \Omega_0 k} = \frac{1}{N_0} \sum_{k=0}^{N_0-1} (a e^{-jr \Omega_0})^k$$

This is a geometric progression, whose sum is found from Sec. B.7-4 as

$$D_r = \frac{1}{N_0} \frac{a^{N_0} e^{-jr \Omega_0 N_0} - 1}{a e^{-jr \Omega_0} - 1} = \frac{a^{N_0} - 1}{N_0 (a e^{-jr \Omega_0} - 1)} \quad \text{because } e^{-jr \Omega_0 N_0} = e^{-j r 2\pi} = 1$$

Therefore

$$\frac{a^{N_0}}{N_0 (a e^{-jr \Omega_0} - 1)} = \frac{a^{N_0}}{N_0 (a \cos r \Omega_0 - j a \sin r \Omega_0 - 1)} = \underbrace{\frac{a^{N_0}}{N_0 (\sqrt{a^2 - 2a \cos r \Omega_0 + 1})}}_{|D_r|} \underbrace{\angle \left\{ -\tan^{-1} \frac{-a \sin r \Omega_0}{a \cos r \Omega_0 - 1} \right\}}_{\angle D_r}$$

**10.1-7** This problem is identical to the analog case analyzed in Sec. 3.1-3 [Eq. (3.19)]. all that is needed is to replace  $f(t)$ ,  $x(t)$ ,  $e(t)$  with  $f[k]$ ,  $x[k]$ ,  $e[k]$  and the integral with summation in that derivation.

**10.1-8** Because  $|f[k]|^2 = f[k] f^*[k]$ , using Eq. (10.8), we obtain

$$P_f = \frac{1}{N_0} \sum_{k=0}^{N_0-1} \left| \sum_{r=0}^{N_0-1} D_r e^{jr \Omega_0 k} \right|^2 = \frac{1}{N_0 - 1} \sum_{k=0}^{N_0-1} \left[ \sum_{r=0}^{N_0-1} D_r e^{jr \Omega_0 k} \sum_{m=0}^{N_0-1} D_m^* e^{-jm \Omega_0 k} \right]$$

Interchanging the order of summation yields

$$P_f = \frac{1}{N_0} \sum_{r=0}^{N_0-1} \sum_{m=0}^{N_0-1} D_r D_m^* \left[ \sum_{k=0}^{N_0-1} e^{j(r-m) \Omega_0 k} \right]$$

From Eq. (5.43) in Appendix 5.1, the sum inside the parenthesis is  $N_0$  when  $r = m$ , and is zero otherwise. Hence

$$P_f = \frac{1}{N_0} \sum_{k=0}^{N_0-1} |f[k]|^2 = \sum_{r=0}^{N_0-1} |D_r|^2$$

**10.2-1 (a)**

$$F(\Omega) = \sum_{k=-\infty}^{\infty} \delta[k] e^{-j\Omega k} = 1$$

(b)

$$F(\Omega) = \sum_{k=-\infty}^{\infty} \delta[k - k_0] e^{-j\Omega k} = e^{-j\Omega k_0}$$

$$|F(\Omega)| = 1 \quad \angle F(\Omega) = -\Omega k_0$$

(c)

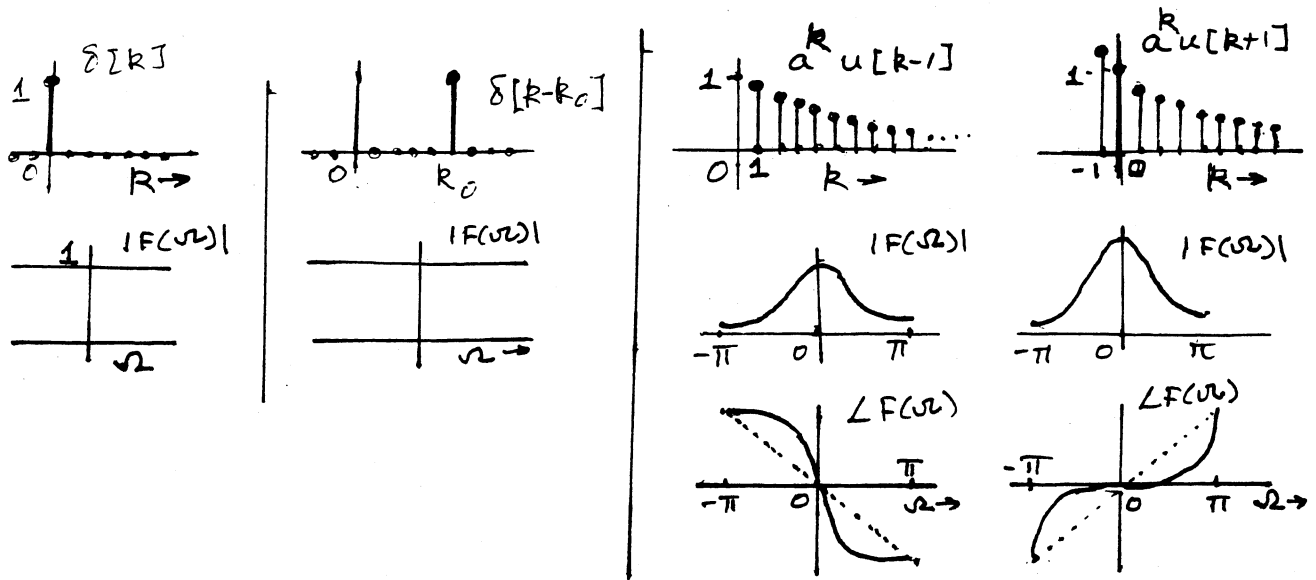

Fig. S10.2-1

$$\begin{aligned}
 F(\Omega) &= \sum_{k=1}^{\infty} a^k e^{-j\Omega k} = \sum_{k=1}^{\infty} (ae^{-j\Omega})^k = \frac{(ae^{-j\Omega})^{\infty} - (ae^{-j\Omega})}{ae^{-j\Omega} - 1} \\
 &= \frac{0 - ae^{-j\Omega}}{ae^{-j\Omega} - 1} = \frac{a}{e^{j\Omega} - a} = \frac{a}{(\cos \Omega - a) + j \sin \Omega} \\
 |F(\Omega)| &= \frac{a}{\sqrt{(1+a^2) - 2a \cos \Omega}} \quad \angle F(\omega) = -\tan^{-1} \left( \frac{\sin \Omega}{\cos \Omega - a} \right)
 \end{aligned}$$

Observe that

$$F(\Omega) = \frac{a}{e^{j\Omega} - a} = \frac{ae^{-j\Omega}}{1 - ae^{-j\Omega}}$$

Comparison of this equation with Eq. (10.37) shows that  $F(\Omega)$  in the present case is  $ae^{-j\Omega}$  times the  $F(\Omega)$  for  $a^k u[k]$ . Clearly, the amplitude spectrum in this case is  $a$  times that in Fig. 10.4b. Moreover, the angle spectrum in the present case is equal to  $-\Omega$  plus that in Fig. 10.4c. This is shown in Fig. S10.2-1a.

(d)

$$\begin{aligned}
 F(\Omega) &= \sum_{k=-1}^{\infty} (ae^{-j\Omega})^k = \frac{(ae^{-j\Omega})^{\infty} - (ae^{-j\Omega})^{-1}}{ae^{-j\Omega} - 1} = \frac{e^{j2\Omega}}{a(e^{j\Omega} - a)} \\
 |F(\Omega)| &= \frac{1}{a\sqrt{1+a^2 - 2a \cos \Omega}} \quad \angle F(\Omega) = 2\Omega - \tan^{-1} \left( \frac{\sin \Omega}{\cos \Omega - a} \right)
 \end{aligned}$$

Observe that

$$F(\Omega) = \frac{e^{j2\Omega}}{a(e^{j\Omega} - a)} = \frac{e^{j\Omega}/a}{1 - ae^{-j\Omega}}$$

Comparison of this equation with Eq. (10.37) shows that  $F(\Omega)$  in the present case is  $\frac{1}{a}e^{-j\Omega}$  times the  $F(\Omega)$  for  $a^k u[k]$ . Clearly, the amplitude spectrum in this case is  $1/a$  times that in Fig. 10.4b. Moreover, the angle spectrum in the present case is equal to  $\Omega$  plus that in Fig. 10.4c. This is shown in Fig. S10.2-1b.

10.2-2 (a)

$$\begin{aligned}
 F(\Omega) &= \sum_{k=-3}^3 f[k]e^{-j\Omega k} = 3 + 2(e^{-j\Omega} + e^{j\Omega}) + (e^{-j2\Omega} + e^{j2\Omega}) \\
 &= 3 + 4 \cos \Omega + 2 \cos 2\Omega
 \end{aligned}$$

(b)

$$\begin{aligned}
F(\Omega) &= \sum_{k=0}^6 f[k]e^{-jk\Omega} = e^{-j\Omega} + 2e^{-j2\Omega} + 3e^{-j3\Omega} + 2e^{-j4\Omega} + e^{-j5\Omega} \\
&= e^{-j3\Omega}[(e^{j2\Omega} + e^{-j2\Omega}) + 2(e^{j\Omega} + e^{-j\Omega}) + 3] \\
&= e^{-j3\Omega}[3 + 4\cos\Omega + 2\cos 2\Omega]
\end{aligned}$$

(c)

$$\begin{aligned}
F(\Omega) &= \sum_{k=-3}^3 f[k]e^{-jk\Omega} = 3e^{-j\Omega} - 3e^{j\Omega} + 6e^{-j2\Omega} - 6e^{-j2\Omega} + 9e^{-j3\Omega} - 9e^{j3\Omega} \\
&= 6j[\sin\Omega + 2\sin 2\Omega + 3\sin 3\Omega]
\end{aligned}$$

(d)

$$\begin{aligned}
F(\Omega) &= \sum_{k=-2}^2 f[k]e^{-jk\Omega} = 2e^{-j\Omega} + 2e^{j\Omega} + 4e^{-j2\Omega} + 4e^{-j2\Omega} \\
&= 4\cos\Omega + 8\cos 2\Omega
\end{aligned}$$

### 10.2-3

$$\begin{aligned}
f[k] &= \frac{1}{2\pi} \int_{2\pi} F(\Omega)e^{jk\Omega} d\Omega \\
&= \frac{1}{2\pi} \int_{-\pi/2}^{\pi/2} \Delta\left(\frac{\Omega}{\pi}\right) e^{jk\Omega} d\Omega
\end{aligned} \tag{1}$$

Instead of evaluating this integral directly, we use the fact that the inverse Fourier transform of  $\Delta\left(\frac{\omega}{\pi}\right)$  is given by  $\frac{1}{4}\text{sinc}^2\left(\frac{\pi t}{4}\right)$  (Pair 20, Table 4.1). This means

$$\frac{1}{2\pi} \int_{-\pi/2}^{\pi/2} \Delta\left(\frac{\omega}{\pi}\right) e^{j\omega t} d\omega = \frac{1}{4}\text{sinc}^2\left(\frac{\pi t}{4}\right)$$

Now setting  $\omega = \Omega$  and  $t = k$  in this equation, we find the integral in Eq. (1) as

$$f[k] = \frac{1}{4}\text{sinc}^2\left(\frac{\pi k}{4}\right)$$

10.3-1 (a)

$$f[k] = a^k u[k] - a^k u[k-10] = a^k u[k] - a^{10} a^{k-10} u[k-10]$$

Now

$$\begin{aligned}
a^k u[k] &\iff \frac{1}{1 - ae^{-j\Omega}} \\
a^{k-10} u[k-10] &\iff \frac{1}{1 - ae^{-j\Omega}} e^{-j10\Omega}
\end{aligned}$$

and

$$f[k] \iff \frac{1}{1 - ae^{-j\Omega}} (1 - a^{10} e^{-j10\Omega})$$

(b) This function is the gate pulse in Example 10.5 delayed by  $k = 4$ . Therefore

$$F(\Omega) = \frac{\sin(4.5\Omega)}{\sin(0.5\Omega)} e^{-j4\Omega}$$

10.3-2 (a)

$$\begin{aligned}
a^k u[k] &\iff \frac{1}{1 - ae^{-j\Omega}} \\
ka^k u[k] &\iff j \frac{d}{d\Omega} \frac{1}{1 - ae^{-j\Omega}} = \frac{ae^{-j\Omega}}{(1 - ae^{-j\Omega})^2}
\end{aligned}$$

and

$$(k+1)a^k u[k] \iff \frac{1+ae^{-j\Omega}}{(1-ae^{-j\Omega})^2}$$

(b)

$$f[k] = a^k \cos \Omega_0 k u[k] = \frac{1}{2} [a^k e^{jk\Omega_0} + a^k e^{-jk\Omega_0}] u[k]$$

$$F(\Omega) = \frac{1}{2} \left[ \frac{1}{1-ae^{-j(\Omega-\Omega_0)}} + \frac{1}{1-ae^{-j(\Omega+\Omega_0)}} \right]$$

$$= \frac{1-ae^{-j\Omega} \cos \Omega_0}{1-2ae^{-j\Omega} \cos \Omega_0 + a^2 e^{-j2\Omega}}$$

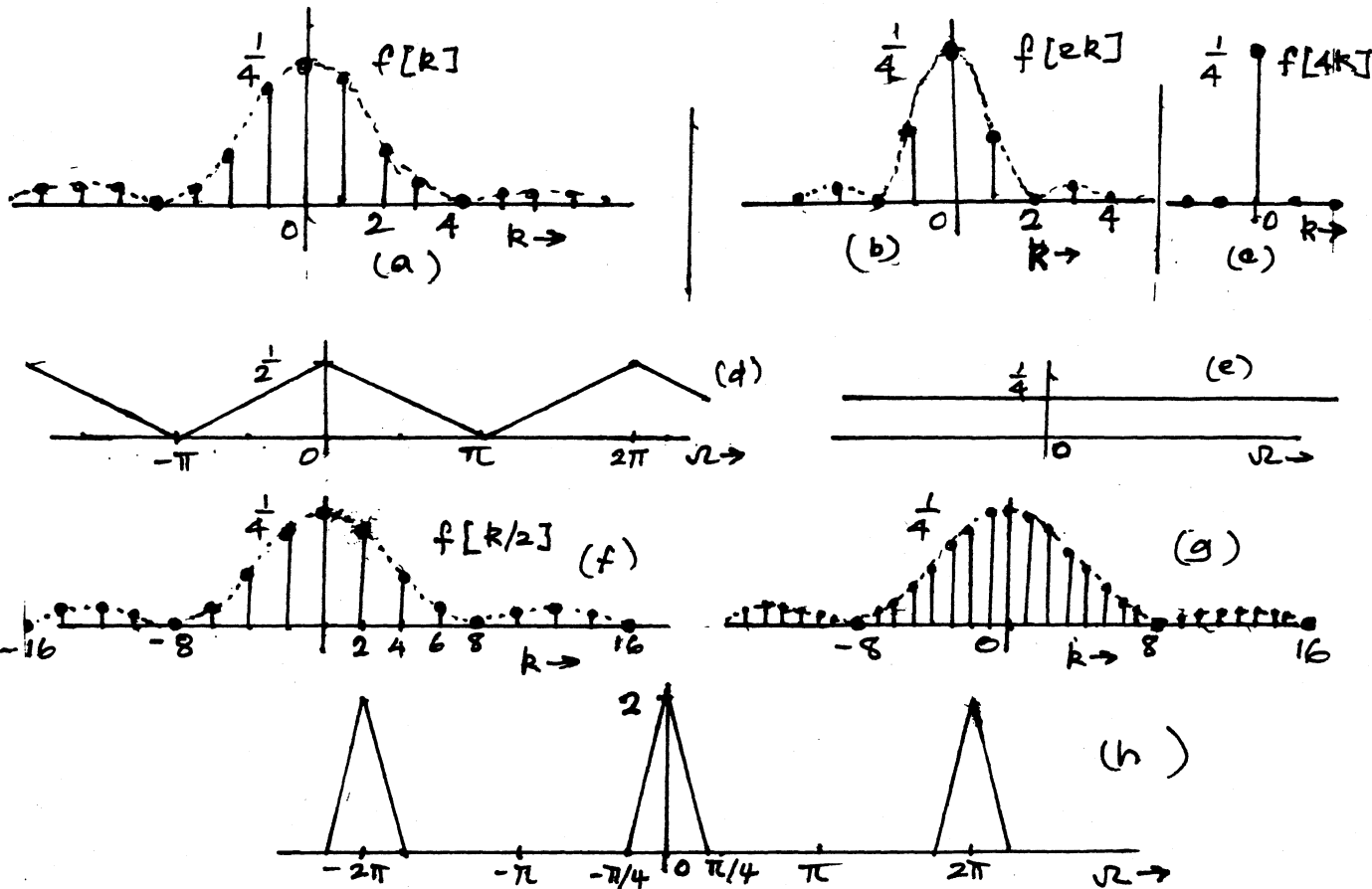

Fig. S10.4-1

10.4-1 (a)

$$f[k] = \frac{1}{2\pi} \int_{-\pi}^{\pi} F(\Omega) e^{jk\Omega} d\Omega = \frac{1}{2\pi} \int_{-\pi/2}^{\pi/2} \Delta\left(\frac{\Omega}{\pi}\right) e^{jk\Omega} d\Omega$$

We can find  $f[k]$  by direct integration as in Example 10.6. We may also use a short cut by recognizing that  $\Delta(\Omega/\pi) = 0$  for  $|\Omega| \geq \pi/2$ ; and the limits of integration in the inverse Fourier integral may as well be from  $-\infty$  to  $\infty$ . Such a change makes this integral the inverse Fourier transform of  $\Delta(\Omega/\pi)$ . This is found from Table 4.1 (with  $\Omega = \omega$  and  $k = t$ ) to be

$$f[k] = \frac{1}{4} \text{sinc}^2\left(\frac{\pi k}{4}\right)$$

This signal is sketched in Fig. S10.4-1a. (b) The signal  $f[2k]$  is  $f[k]$  time-compressed by a factor 2 as shown in Fig. S10.4-1b. We have  $f[2k] = \frac{1}{4} \text{sinc}^2\left(\frac{\pi k}{2}\right)$ . To find  $F(\Omega)$ , we use Eq. (10.55) with  $T = 1$ , and  $f_c(t) = \frac{1}{4} \text{sinc}^2\left(\frac{\pi t}{2}\right)$ . From Table 4.1, we find  $F_c(\omega) = \frac{1}{2} \Delta\left(\frac{\omega}{2\pi}\right)$ , and from Eq. (5.4),  $\overline{F}_c(\omega) = \frac{1}{2} \sum_n \Delta\left(\frac{\omega-2\pi n}{2\pi}\right)$ . Therefore

$F(\Omega) = \overline{F}_c(\Omega) = \frac{1}{2} \sum_n \Delta(\frac{\Omega - 2\pi n}{2\pi})$  as shown in Fig. S10.4-1d. This spectrum is identical to  $F(\Omega)$  in Fig. P10.4-1 frequency expanded by a factor 2 (and multiplied by a constant 1/2).

Using the same argument, we find  $f[4k] = \frac{1}{4} \text{sinc}^2(\pi k)$ . This signal is zero for all values of  $k \neq 0$  as shown in Fig. S10.4-1c. In this case it is trivial to find  $F(\Omega) = \sum f[k]e^{-j\Omega k} = 1/4$ . Thus the spectrum  $F(\Omega)$  in this case is a constant 1/4 as shown in Fig. S10.4-1e. This spectrum is identical to  $F(\Omega)$  in Fig. P10.4-1 frequency expanded by a factor 4 (and multiplied by a constant 1/4).

(c) The signal  $f[k/2]$  is  $f[k]$  time-expanded by a factor 2. This signal has alternate samples missing as shown in Fig. S10.4-1f. Using ideal interpolation, we fill in the missing samples to obtain the interpolated function  $f_i[k] = \frac{1}{4} \text{sinc}^2(\frac{\pi k}{8})$  as shown in Fig. S10.4-1g. Using the argument in part (b), we find  $F_i(\Omega) = 2\Delta(\frac{2\Omega}{\pi})$  as shown in Fig. S10.4-1h.

### 10.5-1

$$F(\Omega) = \frac{1}{1 + 0.5e^{-j\Omega}} = \frac{e^{j\Omega}}{e^{j\Omega} + 0.5}$$

$$Y(\Omega) = F(\Omega)H(\Omega) = \frac{e^{j\Omega}(e^{j\Omega} + 0.32)}{(e^{j\Omega} + 0.5)(e^{j\Omega} + 0.8)(e^{j\Omega} + 0.2)}$$

$$\frac{Y(\Omega)}{e^{j\Omega}} = \frac{e^{j\Omega} + 0.32}{(e^{j\Omega} + 0.5)(e^{j\Omega} + 0.8)(e^{j\Omega} + 0.2)}$$

$$= \frac{2}{e^{j\Omega} + 0.5} - \frac{8/3}{e^{j\Omega} + 0.8} + \frac{2/3}{e^{j\Omega} + 0.2}$$

$$Y(\Omega) = 2\frac{e^{j\Omega}}{e^{j\Omega} + 0.5} - \frac{8}{3}\frac{e^{j\Omega}}{e^{j\Omega} + 0.8} + \frac{2}{3}\frac{e^{j\Omega}}{e^{j\Omega} + 0.2}$$

$$y[k] = \left[ 2(-0.5)^k - \frac{8}{3}(-0.8)^k + \frac{2}{3}(-0.2)^k \right] u[k]$$

### 10.5-2

$$f[k] = \frac{1}{3} \left(\frac{1}{3}\right)^k \quad \text{and} \quad F(\Omega) = \frac{1}{3} \frac{e^{j\Omega}}{e^{j\Omega} - 1/3}$$

$$Y(\Omega) = F(\Omega)H(\Omega) = \frac{1}{3} \frac{e^{j\Omega}(e^{j\Omega} - 0.5)}{(e^{j\Omega} - 1/3)(e^{j\Omega} + 0.5)(e^{j\Omega} - 1)}$$

$$\frac{Y(\Omega)}{e^{j\Omega}} = \frac{1}{3} \frac{e^{j\Omega} - 0.5}{(e^{j\Omega} - 1/3)(e^{j\Omega} + 0.5)(e^{j\Omega} - 1)} = \frac{1}{3} \left[ \frac{0.3}{e^{j\Omega} - 1/3} - \frac{0.8}{e^{j\Omega} + 0.5} + \frac{0.5}{e^{j\Omega} - 1} \right]$$

$$Y(\Omega) = \frac{1}{3} \left[ 0.3 \frac{e^{j\Omega}}{e^{j\Omega} - 1/3} - 0.8 \frac{e^{j\Omega}}{e^{j\Omega} + 0.5} + 0.5 \frac{e^{j\Omega}}{e^{j\Omega} - 1} \right]$$

$$y[k] = \left[ \frac{1}{10} \left(\frac{1}{3}\right)^k - \frac{4}{15}(-0.5)^k + \frac{1}{6} \right] u[k]$$

### 10.5-3

$$F(\Omega) = \frac{e^{j\Omega}}{e^{j\Omega} - 0.8} - \frac{2e^{j\Omega}}{e^{j\Omega} - 2}$$

$$Y(\Omega) = F(\Omega)H(\Omega) = \frac{e^{j2\Omega}}{(e^{j\Omega} - 0.5)(e^{j\Omega} - 0.8)} - \frac{2e^{j2\Omega}}{(e^{j\Omega} - 0.5)(e^{j\Omega} - 2)}$$

$$= \frac{-5/3}{e^{j\Omega} - 0.5} + \frac{8/3}{e^{j\Omega} - 0.8} + \frac{2/3}{e^{j\Omega} - 0.5} - \frac{8/3}{e^{j\Omega} - 2}$$

$$= \frac{-1}{e^{j\Omega} - 0.5} + \frac{8/3}{e^{j\Omega} - 0.8} - \frac{8/3}{e^{j\Omega} - 2}$$

$$Y(\omega) = -\frac{e^{j\Omega}}{e^{j\Omega} - 0.5} + \frac{8}{3}\frac{e^{j\Omega}}{e^{j\Omega} - 0.8} - \frac{8}{3}\frac{e^{j\Omega}}{e^{j\Omega} - 2}$$

$$y[k] = \left[ -(0.5)^k + \frac{8}{3}(0.8)^k \right] u[k] + \frac{8}{3}(2)^k u[-(k+1)]$$

10.6-1 We construct the 3-point periodic extension of  $f[k]$  as

$$3, \underbrace{3}_{k=0}, 2, 3, 3, 2, 3, 3, 2, \dots$$

The values of  $f[k]$  at  $k = 0, 1, \text{ and } 2$  are 3, 2, and 3 respectively. We use these values to compute the DFT. This problem is now identical to Example 10.8, which is already solved in the text. The DFT is given by

$$F_0 = 8, F_1 = e^{j\frac{\pi}{3}}, F_2 = e^{-j\frac{\pi}{3}}$$

The DTFT of this signal is

$$F(\Omega) = \sum_{k=-1}^1 f[k]e^{-j\Omega k} = 3e^{j\Omega} + 3 + 2e^{-j\Omega}$$

Observe that  $F(0) = 8$ ,  $F(\frac{2\pi}{3}) = 0.5 + j0.866 = e^{j\pi/6} = F_1$ . Similarly  $F(\frac{4\pi}{3}) = 0.5 - j0.866 = e^{-j\pi/6} = F_2$ .

(b) Recall that the  $N_0$ -point DFT of  $f[k]$  characterizes the  $N_0$ -periodic extension of  $f[k]$  and not just the  $f[k]$ . Because the 3-point periodic extension of this signal is identical to the 3-point periodic extension of the signal in Fig. 10.11a, the DFTs of the two signals are identical. This does not mean that the DTFTs of the two signals are identical. All it says is that the two DTFTs are identical at the  $N_0$  sample points. We may verify from the fact that the DTFT of the signal in Fig. 10.11a is

$$\hat{F}(\Omega) = \sum_{k=0}^2 f[k]e^{-j\Omega k} = 3 + 2e^{-j\Omega} + 3e^{-j2\Omega}$$

Observe that  $F(0) = 8$ ,  $F(\frac{2\pi}{3}) = 0.5 + j0.866 = e^{j\pi/6} = F_1$ . Similarly  $F(\frac{4\pi}{3}) = 0.5 - j0.866 = e^{-j\pi/6} = F_2$ .

(c) To find the 8-point DFT of this signal, we pad 5 zeros. The 8-periodic extension of this padded signal is

$$3, \underbrace{3}_{k=0}, 2, 0, 0, 0, 0, 0, 3, 3, 2, 0, \dots$$

To compute 8-point DFT, we select the 8 values starting from  $k = 0$ . These are 3, 2, 0, 0, 0, 0, 0, 3. The 8-point DFT is

$$F_7 = \sum_{k=0}^7 f[k]e^{-jr\frac{\pi}{4}k} = 3 + 2e^{-jr\frac{\pi}{4}} + 3e^{-jr\frac{7\pi}{4}}$$

This yields

$$F_0 = 8, F_1 = 6.5355 + j0.707, F_2 = 3 + j, F_3 = -0.5355 + j0.707, F_4 = -2, F_5 = -0.5355 - j0.707,$$

$$F_6 = 3 - j, F_7 = 6.5355 - j0.707$$

**10.6-2** This is a 4-point signal starting at  $k = 0$ . The four points are 1, 2, 2, 1. Also  $\Omega_0 = \pi/2$ . Hence, the 4-point DFT is

$$F_r = \sum_{k=0}^3 f[k]e^{-jr\frac{\pi}{2}k} = 1 + 2e^{-jr\frac{\pi}{2}} + 2e^{-jr\pi} + e^{-jr\frac{3\pi}{2}}$$

This yields

$$F_0 = 6, F_1 = -1 - j, F_2 = 0, F_3 = -1 + j$$

For 8-point DFT, we pad 4 zeros to  $f[k]$ . This yields the 8-point sequence 1, 2, 2, 1, 0, 0, 0, 0. Also,  $\Omega_0 = 2\pi/8 = \pi/4$ . Hence,

$$F_r = \sum_{k=0}^7 f[k]e^{-jr\frac{\pi}{4}k} = e^{-jr\frac{\pi}{4}} + 2e^{-jr\frac{\pi}{2}} + 2e^{-jr\frac{3\pi}{4}} + 1e^{-jr\pi}$$

This yields

$$F_0 = 6, F_1 = -1.707 - j4.1213, F_2 = -1 - j, F_3 = 0.2929 - j0.1213, F_4 = 0, F_5 = 0.2929 + j0.1213,$$

$$F_6 = -1 + j, F_7 = 1.707 + j4.1213$$

(b)

$$F(\Omega) = \sum_{k=0}^3 f[k]e^{-j\Omega k} = 1 + 2e^{-j\Omega} + 2e^{-j2\Omega} + e^{-j3\Omega}$$



For the 4-point case,  $\Omega_0 = \pi/2$ , and the DFT is

$$F_r = F\left(r\frac{\pi}{4}\right) = 1 + 2e^{-jr\pi/2} + 2e^{-jr\pi} + e^{-jr3\pi/2}$$

Substitution of  $r = 0, 1, 2, 3$  yields the same DFT values found earlier.

For the 8-point case,  $\Omega_0 = \pi/4$ , and the DFT is

$$F_r = F(r\pi/2) = 1 + 2e^{-jr\pi/4} + 2e^{-jr\pi/2} + e^{-jr3\pi/4}$$

Substitution of  $r = 0, 1, 2, 3, 4, 5, 6, 7$  yields the same DFT values found earlier.

- 10.6-3** In this case  $N_0 = 1$  and  $\Omega_0 = 2\pi$ . Hence, the DFT is a single-point given by  $F_0 = f[0]e^0 = f[0] = 1$ . Also  $F(\Omega) = f[0]e^{-j\Omega} = f[0] = 1$ . Thus  $F(\Omega)$  is constant for all  $\Omega$ . The DFT is a sample of this  $F(\Omega)$  at  $\omega = 0$ , which is 1.

(b) The signal  $\delta[k - m]$  is also a single-point signal. The one-point periodic extension of this signal is a signal  $f_{N_0}[k] = 1$  for all  $k$ . Hence we pick its value at  $k = 0$  (which is 1) to compute a single-point DFT. Thus,  $F_0 = 1 \times e^0 = 1$ . This is identical to the DFT of  $\delta[k]$ .

(c) In this case, we pad  $N_0 - 1$  zeros, and the zero-padded signal is 1, 0, 0, 0,  $\dots$ , 0, 0. Hence,

$$F_r = \sum_{k=0}^{N_0-1} f[k]e^{-jr\Omega_0 k} = 1 + 0 + 0 + 0 \dots + 0 = 1 \quad \text{for all } r$$

The  $N_0$ -point DFT is a set of  $N_0$  uniform samples of  $F(\Omega)$  over the frequency interval of  $2\pi$ . But  $F(\Omega) = 1$  for all  $\Omega$ . Hence, all the  $N_0$  samples (the DFT) are 1.

- 10.6-4 (a)**

$$F_r = \sum_{k=0}^{N_0-1} f[k]e^{-jr\Omega_0 k} = \sum_{k=0}^{N_0-1} e^{-jr\Omega_0 k}$$

This is a geometrical progression whose sum is derived in Eq. (5.43) as  $N_0$  for  $r = 0$ , and is zero for all other values of  $r$ . Thus,  $F_0 = N_0$  and  $F_r = 0$  for  $r = 1, 2, 3, \dots, N_0 - 1$ . Also

$$F(\Omega) = \sum_{k=0}^{N_0-1} f[k]e^{-j\Omega k} = \sum_{k=0}^{N_0-1} e^{-j\Omega k} = \frac{e^{-jN_0\Omega} - 1}{e^{-j\Omega} - 1}$$

Observe that (using L'Hopital rule)  $F(0) = N_0$ . But

$$F\left(r\frac{2\pi}{N_0}\right) = \frac{e^{-jrN_0\frac{2\pi}{N_0}} - 1}{e^{-jr\frac{2\pi}{N_0}} - 1} = 0 \quad \text{for all } r \neq 0 \text{ because } e^{-j2\pi r} = 1$$

(b) It is clear that the DFT is taking all the samples where  $F(\Omega) = 0$  with the exception of the sample at  $\Omega = 0$ . Clearly, the DFT in this case is a poor description of  $F(\Omega)$ . The situation can be remedied by taking more samples. This can be done by padding zeros to  $f[k]$ . We should add at least  $N_0$  number of zeros to get a fair idea of  $F(\Omega)$  from the DFT.

- 10.6-5** This is a 5-point signal that does not start at  $k = 0$ . The 5-point periodic extension of this signal is

4, 2,  $\underbrace{0}_{k=0}$ , 2, 4, 4, 2, 0, 2, 4,  $\dots$ . The five points starting at  $k = 0$  are 0, 2, 4, 4, 2. Also  $\Omega_0 = 2\pi/5$ . Hence, the 5-point DFT is

$$F_r = \sum_{k=0}^4 f[k]e^{-jr\frac{2\pi}{5}k} = 2e^{-jr\frac{2\pi}{5}} + 4e^{-jr\frac{4\pi}{5}} + 4e^{-jr\frac{6\pi}{5}} + 2e^{-jr\frac{8\pi}{5}}$$

This yields

$$F_0 = 12, F_1 = -5.2361, F_2 = -0.7639, F_3 = -0.7639, F_4 = -5.2361$$

For 8-point DFT, we pad 3 zeros to  $f[k]$  and then take the 8-point periodic extension, whose first cycle yields 0, 2, 4, 0, 0, 0, 4, 2. Also,  $\Omega_0 = 2\pi/8 = \pi/4$ . Hence,

$$F_r = \sum_{k=0}^7 f[k]e^{-jr\frac{\pi}{4}k} = 2e^{-jr\frac{\pi}{4}} + 4e^{-jr\frac{\pi}{2}} + 4e^{-jr\frac{3\pi}{4}} + 2e^{-jr\frac{7\pi}{4}}$$

This yields

$$F_0 = 12, F_1 = 2.8284, F_2 = -8, F_3 = -2.8284, F_4 = 4, F_5 = -2.8284, F_6 = -8, F_7 = 2.8284,$$

(b)

$$F(\Omega) = \sum_{k=-2}^2 f[k]e^{-j\Omega k} = 4e^{j2\Omega} + 2e^{j\Omega} + 2e^{-j\Omega} + 4e^{-j2\Omega} = 4 \cos \Omega + 8 \cos 2\Omega$$

For the 5-point case,  $\Omega_0 = 2\pi/5$ , and the DFT is

$$F_r = 4 \cos(2\pi r/5) + 8 \cos(4\pi r/5)$$

Substitution of  $r = 0, 1, 2, 3, 4$  yields the same 4-point DFT values found earlier.

For the 8-point case,  $\Omega_0 = \pi/4$ , and the DFT is

$$F_r = 4 \cos(\pi r/4) + 8 \cos(\pi r/2)$$

Substitution of  $r = 0, 1, 2, \dots, 7$  yields the same 8-point DFT found earlier.

**10.6-6 (a)** Figure S10.6-6a shows the graphical construct required for circular convolution. The outer circle is rotated clockwise, one unit at a time, and then the corresponding  $f$  and  $g$  values are multiplied and the products added to yield  $c[0] = 7, c[1] = 9, c[2] = 11, c[3] = 9$ .

(b) Figure S10.6-6b shows the sliding tape construct required for linear convolution. The lower strip is advanced, one unit at a time, and then the corresponding  $f$  and  $g$  values are multiplied and the products added to yield  $c[0] = 0, c[1] = 2, c[2] = 5, c[3] = 9, c[4] = 7, c[5] = 7, c[6] = 6$ .

(c) In this case  $N_f = N_g = 4$ . Hence each sequence should be padded with  $7 - 4 = 3$  zeros. Figure S10.6-6c shows the graphical construct required for circular convolution using the 7-point padded  $f$  and  $g$  sequences. The outer circle is rotated clockwise, one unit at a time, and then the corresponding  $f$  and  $g$  values are multiplied and the products added to yield  $c[0] = 0, c[1] = 2, c[2] = 5, c[3] = 9, c[4] = 7, c[5] = 7, c[6] = 6$ , which is identical to the answer in part (b).

(d) **The Periodic Convolution by DFT** For this purpose, we need  $F_k$  and  $G_k$  for unpadded  $f[k]$  and  $g[k]$ . Both signals are 4-point sequences, that is  $N_0 = 4$  and  $\Omega_0 = \pi/2$ , and

$$F_r = \sum_{k=0}^3 f[k]e^{-jr\frac{\pi}{2}k} = e^{-jr\frac{\pi}{2}} + 2e^{-jr\pi} + 3e^{-jr\frac{3\pi}{2}}$$

Hence

$$F_0 = 1 + 2 + 3 = 6, F_1 = -j - 2 + 3j = -2 + j2, F_2 = -1 + 2 - 3 = -2, F_3 = j - 2 - j3 = -2 - j2$$

and

$$G_r = \sum_{k=0}^3 g[k]e^{-jr\frac{\pi}{2}k} = 2 + e^{-jr\frac{\pi}{2}} + e^{-jr\pi} + 2e^{-jr\frac{3\pi}{2}}$$

Hence,  $H_0 = 3 + 2 + 1 + 1 = 7$  and

$$G_0 = 2 + 1 + 1 + 2 = 6, G_1 = 2 - j - 1 + j2 = 1 + j, G_2 = 2 - 1 + 1 - 2 = 0, G_3 = 2 + j - 1 - 2j = 1 - j$$

From these values, we compute  $C_r = F_r G_r$  as

$$C_0 = 36, C_1 = -4, C_2 = 0, C_3 = -4$$

The IDFT of  $C_r$  is given by

$$c[k] = \frac{1}{4} \sum_{r=0}^3 C_r e^{jr\frac{\pi}{2}k} = \frac{1}{4} [36 - 4e^{j\frac{\pi}{2}k} - 4e^{j\frac{3\pi}{2}k}]$$

From this equation, we obtain  $c[0] = 7, c[1] = 9, c[2] = 11, c[3] = 9$

(e) **The Linear Convolution by DFT** We repeat the procedure in part (d) using padded sequences. In this case  $N_0 = 7$  and  $\Omega_0 = 2\pi/7$ , and

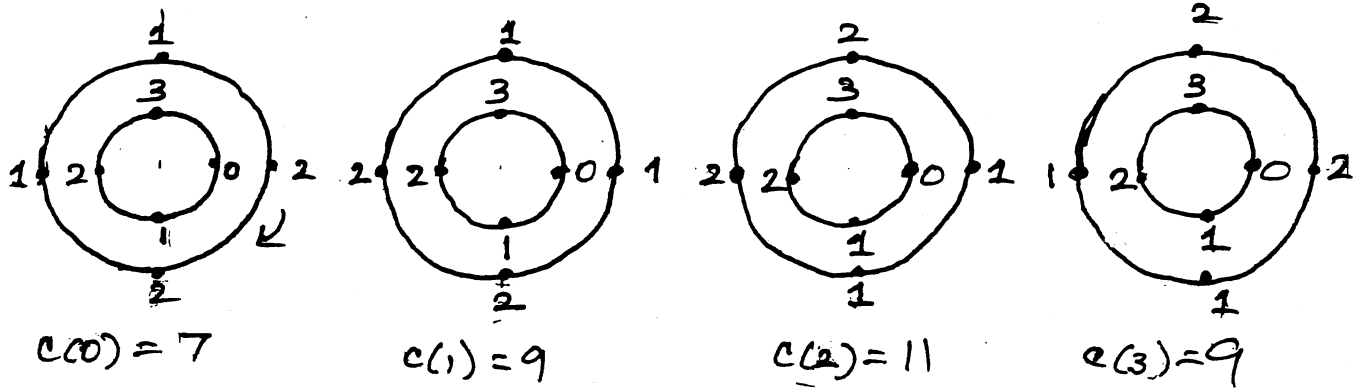

(a)

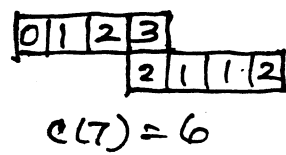
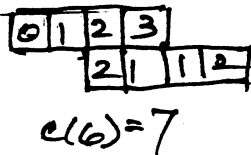
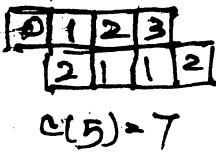
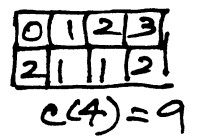
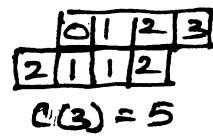
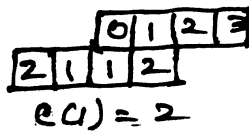
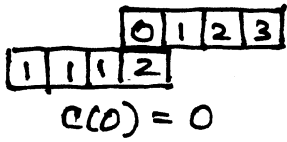

(b)

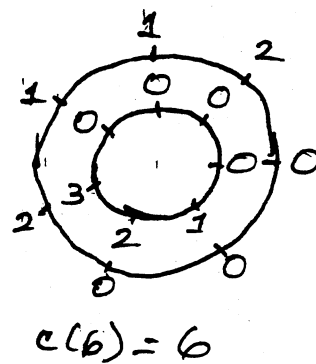
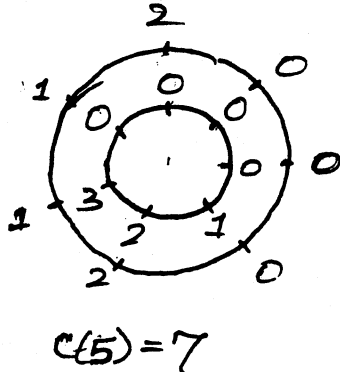
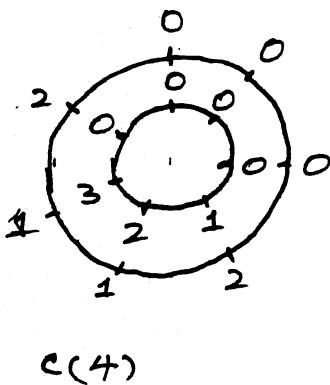
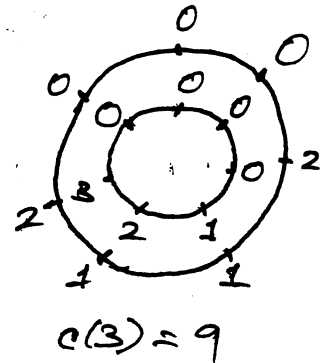
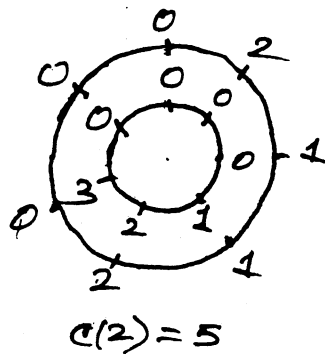
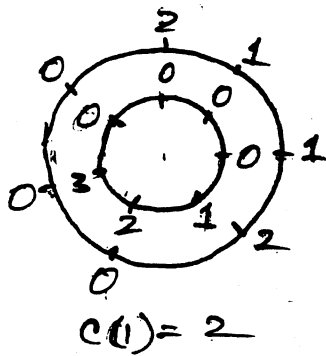
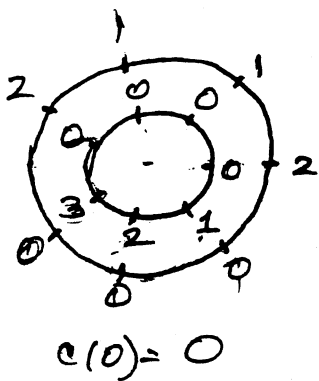

(c)

Fig. S10.6-6

$$F_r = \sum_{k=0}^6 f[k] e^{-jr \frac{2\pi}{7} k} = e^{-jr \frac{2\pi}{7}} + 2e^{-jr \frac{4\pi}{7}} + 3e^{-jr \frac{6\pi}{7}}$$

where  $f[k] = [0, 1, 2, 3, 0, 0, 0]$ . Substitution of the values of  $f[k]$  in the preceding equation for  $F_r$  yields

$$F_r = [6, -2.5245 - j4.0333, -0.154 + j2.2383, -0.3216 - j1.795, -0.3216 + j1.795, -0.154 - j2.2383, -2.5245 + j4.0333]$$

Also

$$G_r = \sum_{k=0}^6 g[k] e^{-jr \frac{2\pi}{7} k} = 2 + e^{-jr \frac{2\pi}{7}} + e^{-jr \frac{4\pi}{7}} + 2e^{-jr \frac{6\pi}{7}}$$

where  $g[k] = [2, 1, 1, 2, 0, 0, 0]$ . Substitution of these values in the preceding equation for  $G_r$  yields

$$G_r = [6, 0.599 - j2.6245, 2.12345 + j1.0226, 1.2775 - j1.6019, 1.2775 + j1.6019, 2.12345 - j1.0226, 0.599 + j2.6245]$$

From these values, we compute  $C_r = F_r G_r$  as

$$C_r = [36, -12.098 + j4.2094, -2.616 + j4.5956, 3.2862 - j1.778, 3.2862 + j1.778, -2.616 - j4.55956, -12.098 - j4.2094]$$

The IDFT of  $C_r$  is given by

$$c[k] = \frac{1}{7} \sum_{r=0}^6 C_r e^{jr \frac{2\pi}{7} k}$$

In this equation we substitute the values of  $C_r$  found earlier to obtain

$$c[k] = [0, 2, 5, 9, 7, 7, 6]$$

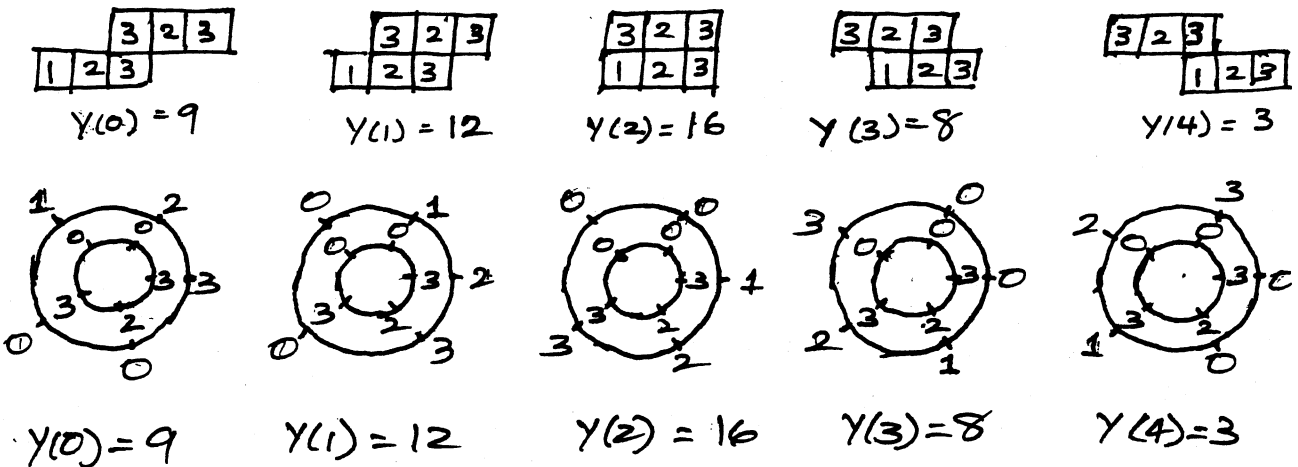

Fig. S10.6-7

10.6-7 (i) We find the response by linear convolution using the sliding tape method. The two tapes are shown in fig. S10.6-7a. We advance the lower tape one unit at a time, multiply the corresponding  $f$  and  $h$  values and add. This yields  $y[0] = 9, y[1] = 12, y[2] = 16, y[3] = 8, y[4] = 3$ . All the remaining values are 0.

(ii) To obtain the correct answer by circular convolution, we must pad  $f[k]$  with  $N_h - 1 = 3$  zeros and  $g[k]$  with  $N_f - 1 = 2$  zeros, resulting in 6-point sequences  $[3, 2, 3, 0, 0, 0]$  and  $[3, 2, 1, 1, 0, 0]$ . Figure S10.6-7b shows the graphical construct required for circular convolution. The outer circle is rotated clockwise, one unit at a time, and then the corresponding  $f$  and  $g$  values are multiplied and the products added to yield  $y[0] = 9, y[1] = 12, y[2] = 16, y[3] = 8, y[4] = 3$ . The sequence repeats periodically.

(iii) For the use of DFT, we use the padded sequences in part (ii). In this case  $N_0 = 5, \Omega_0 = 2\pi/5$ , and

$$F_r = \sum_{k=0}^4 f[k] e^{-jr \frac{2\pi}{5} k} = 3e^{-jr \frac{2\pi}{5}} + 2e^{-jr \frac{4\pi}{5}} + 3e^{-jr \frac{6\pi}{5}}$$

Hence,

$$F_0 = 3 + 2 + 3 = 8, F_1 = 3.854e^{-j1.2566}, F_2 = 2.854e^{j0.6283}, F_3 = 2.854e^{-j0.6283}, F_4 = 3.854e^{j1.2566}$$

Also

$$H_r = \sum_{k=0}^4 h[k]e^{-jr\frac{2\pi}{5}k} = 3e^{-jr\frac{2\pi}{5}} + 2e^{-jr\frac{4\pi}{5}} + e^{-jr\frac{6\pi}{5}}$$

Hence,

$$H_0 = 3 + 2 + 1 = 6, H_1 = 3.7537e^{-j0.7252}, H_2 = 1.7058e^{-j0.1320}, H_3 = 1.7058e^{j0.1320}, H_4 = 3.7537e^{j0.7252}$$

From these values, we compute  $Y_r = F_r H_r$  as

$$Y_0 = 48, Y_1 = 14.467e^{-j1.9818}, Y_2 = 4.8685e^{j0.4963}, Y_3 = 4.8685e^{-j0.4963}, Y_4 = 14.467e^{j1.9818}$$

The IDFT of  $Y_r$  is given by

$$y[k] = \frac{1}{5} \sum_{r=0}^4 Y_r e^{jr\frac{2\pi}{5}k}$$

From this equation, we obtain  $y[0] = 9, y[1] = 12, y[2] = 16, y[3] = 8, y[4] = 3$ . All the remaining values are 0.

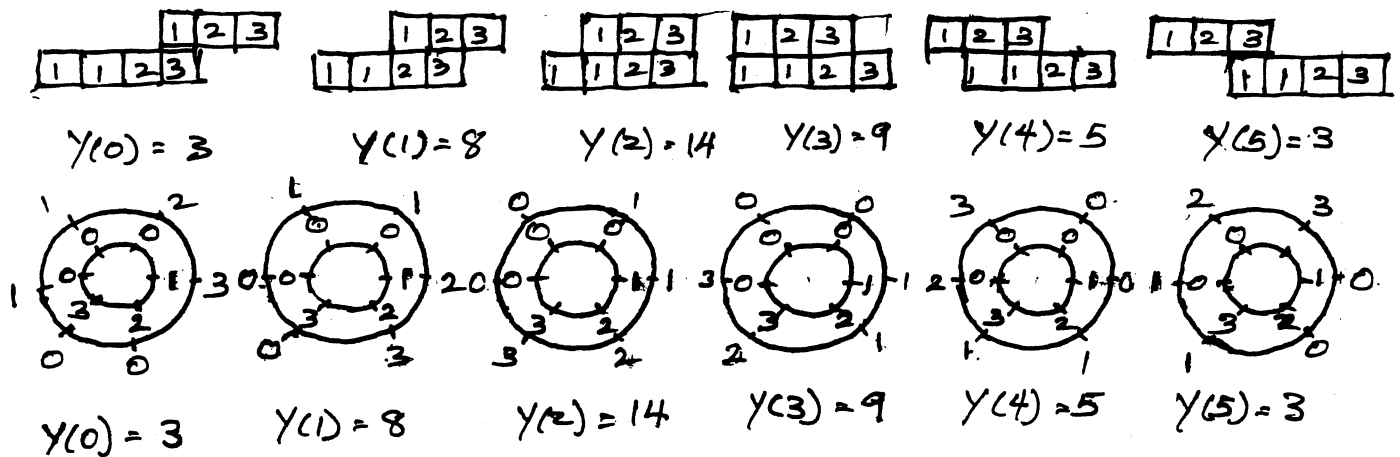

Fig. S10.6-8

10.6-8 (i) We find the response by linear convolution using the sliding tape method. The two tapes are shown in fig. S10.6-8a. We advance the lower tape one unit at a time, multiply the corresponding  $f$  and  $h$  values and add. This yields  $y[0] = 3, y[1] = 8, y[2] = 14, y[3] = 9, y[4] = 5, y[5] = 3$ . All the remaining values are 0.

(ii) To obtain the correct answer by circular convolution, we must pad  $f[k]$  with  $N_h - 1 = 3$  zeros and  $g[k]$  with  $N_f - 1 = 2$  zeros, resulting in 6-point sequences  $[1, 2, 3, 0, 0, 0]$  and  $[3, 2, 1, 1, 0, 0]$ . Figure S10.6-8b shows the graphical construct required for circular convolution. The outer circle is rotated clockwise, one unit at a time, and then the corresponding  $f$  and  $g$  values are multiplied and the products added to yield  $y[0] = 3, y[1] = 8, y[2] = 14, y[3] = 9, y[4] = 5, y[5] = 3$ . The sequence repeats periodically.

(iii) For the use of DFT, we use the padded sequences in part (ii). In this case  $N_0 = 6, \Omega_0 = \pi/3$ , and

$$F_r = \sum_{k=0}^5 f[k]e^{-jr\frac{\pi}{3}k} = 1 + 2e^{-jr\frac{\pi}{3}} + 3e^{-jr\frac{2\pi}{3}}$$

Hence,  $F_0 = 1 + 2 + 3 = 6$  and

$$F_1 = 1 + 2e^{-j\frac{\pi}{3}} + 3e^{-j\frac{2\pi}{3}} = 1 + 2\frac{1 - j\sqrt{3}}{2} + 3\frac{-1 - j\sqrt{3}}{2} = \frac{1 - j5\sqrt{3}}{2}$$

Similarly, we find  $F_2 = \frac{-3 + j\sqrt{3}}{2}, F_3 = 2, F_4 = \frac{-3 - j\sqrt{3}}{2},$  and  $F_5 = \frac{1 + j5\sqrt{3}}{2}$ .

and

$$H_r = \sum_{k=0}^5 h[k]e^{-jr\frac{\pi}{3}k} = 3 + 2e^{-jr\frac{\pi}{3}} + e^{-jr\frac{2\pi}{3}} + e^{-jr\pi}$$

Hence,  $H_0 = 3 + 2 + 1 + 1 = 7$  and

$$H_1 = 3 + 2e^{-j\frac{\pi}{3}} + e^{-j\frac{2\pi}{3}} - 1 = 3 + 2\frac{1-j\sqrt{3}}{2} + \frac{-1-j\sqrt{3}}{2} - 1 = \frac{5-j3\sqrt{3}}{2}$$

Similarly, we find  $H_2 = \frac{5-j\sqrt{3}}{2}$ ,  $H_3 = 1$ ,  $H_4 = \frac{5+j\sqrt{3}}{2}$ , and  $H_5 = \frac{5+j3\sqrt{3}}{2}$ .

From these values, we compute  $Y_r = F_r H_r$  as

$$Y_0 = 42, Y_1 = -10 - j7\sqrt{3}, Y_2 = -3 + j2\sqrt{3}, Y_3 = 2, Y_4 = -3 - j2\sqrt{3}, Y_5 = -10 + j7\sqrt{3}$$

The IDFT of  $Y_r$  is given by

$$\begin{aligned} y[k] &= \frac{1}{6} \sum_{r=0}^5 Y_r e^{jr\frac{\pi}{3}k} \\ &= \frac{1}{6} \left[ 42 + (-10 - j7\sqrt{3})e^{j\frac{\pi}{3}k} + (-3 + j2\sqrt{3})e^{j\frac{2\pi}{3}k} + 2e^{j\pi k} + (-3 - j2\sqrt{3})e^{j\frac{4\pi}{3}k} + (-10 + j7\sqrt{3})e^{j\frac{5\pi}{3}k} \right] \end{aligned}$$

From this equation, we obtain

$y[0] = 3, y[1] = 8, y[2] = 14, y[3] = 9, y[4] = 5, y[5] = 3$ . All the remaining values are 0.

overlap and add method

overlap & save method

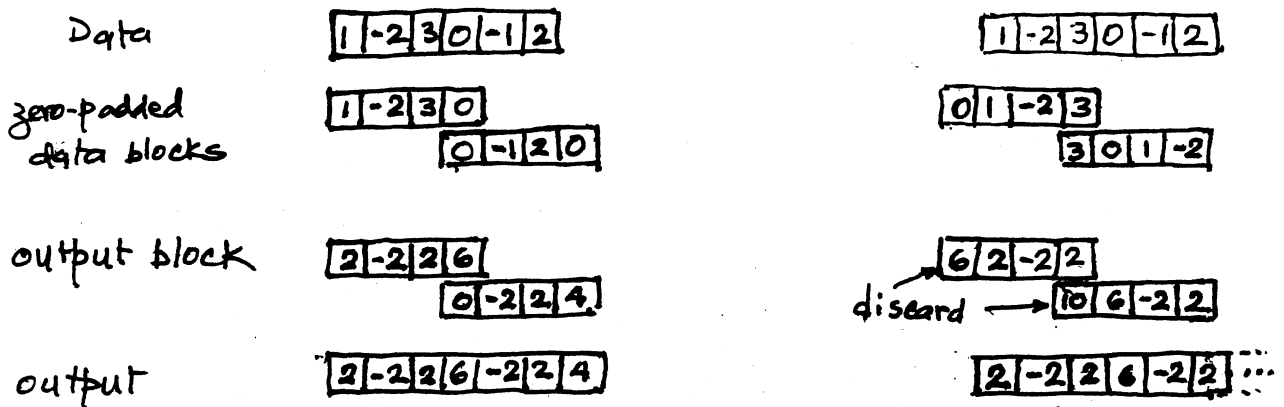

Fig. 10.6-9

10.6-9 The output  $y[k]$  is a linear convolution of  $f[k]$  and  $h[k]$ . We can readily obtain the linear convolution of  $f[k]$  and  $h[k]$  as  $y[k] = \{2, -2, 2, 6, -2, 2, 4\}$

#### Overlap and Add Method

We shall use  $L = 3$  for the block convolution. In this case  $M = 2$ . Hence, we need to break the input sequence in blocks of 3 digits and pad each block with  $M - 1 = 1$  zero. Thus, the first block is  $f_1[k] = \{1, -2, 3, 0\}$ , and the second block is  $f_2[k] = \{0, -1, 2, 0\}$ . We convolve each of these blocks with  $h[k] = \{2, 2\}$ , which becomes  $h[k] = \{2, 2, 0, 0\}$  after padding by  $L - 1 = 2$  zeros.

We may perform circular convolution of the two blocks  $f_1[k] = \{1, -2, 3, 0\}$  and  $f_2[k] = \{0, -1, 2, 0\}$  with the padded impulse response  $h[k] = \{2, 2, 0, 0\}$ . The reader may verify that this yields  $y_1[k] = \{2, -2, 2, 6\}$  and  $y_2[k] = \{0, -2, 2, 4\}$ . The two output blocks are added as shown in Fig. S10.6-9 to obtain the final output  $y[k] = \{2, -2, 2, 6, -2, 2, 4\}$ . We may also obtain this result using DFT procedure described below.

In this case  $N_0 = 4$ , and  $\Omega_0 = \pi/2$ . The DFTs  $F_r$  and  $H_r$  of the zero-padded sequences  $f[k]$  and  $h[k]$  are given by

$$F_r = \sum_{k=0}^2 f[k]e^{-jr\frac{\pi}{2}k} \quad \text{and} \quad H_r = \sum_{k=0}^1 h[k]e^{-jr\frac{\pi}{2}k}$$

Also  $Y_r = F_r H_r$ . We compute the values of  $F_r$ ,  $H_r$ , and  $Y_r$  using these equations for each block:  
For the first block,

$$F_r = 1 - 2e^{-j\frac{\pi}{2}r} + 3e^{-j\pi r}, \quad H_r = 2 + 2e^{-j\frac{\pi}{2}r} \quad \text{and} \quad Y_r = F_r H_r$$

Also

$$y[k] = \frac{1}{4} \sum_{r=0}^3 Y_r e^{jr\frac{\pi}{2}k} = \frac{1}{4} \left( Y_0 + Y_1 e^{j\frac{\pi}{2}k} + Y_2 e^{j\pi k} + Y_3 e^{j\frac{3\pi}{2}k} \right)$$

Substituting  $r = 0, 1, 2, 3$ , we obtain

$$\begin{array}{llll} F_0 = 2 & F_1 = -2(1+j) & F_2 = 6 & F_3 = 2(-1-j) \\ H_0 = 4 & H_1 = 2(1-j) & H_2 = 0 & H_3 = 2(1+j) \\ Y_0 = 8 & Y_1 = j8 & Y_2 = 0 & Y_3 = -j8 \\ y[0] = 2 & y[1] = -2 & y[2] = 2 & y[3] = 6 \end{array}$$

We use the same procedure for the second block to obtain

$$F_r = -e^{-j\frac{\pi}{2}r} + 2e^{-j\pi r} \quad \text{and} \quad H_r = 2 + 2e^{-j\frac{\pi}{2}r}$$

Substituting  $r = 0, 1, 2, 3$ , we obtain

$$\begin{array}{llll} F_0 = 1 & F_1 = -2+j & F_2 = 3 & F_3 = -2-j \\ H_0 = 4 & H_1 = 2(1-j) & H_2 = 0 & H_3 = 2(1+j) \\ Y_0 = 4 & Y_1 = 2(-1+j3) & Y_2 = 0 & Y_3 = 2(-1-j3) \\ y[0] = 0 & y[1] = -2 & y[2] = 2 & y[3] = 4 \end{array}$$

The fourth point of the first output block overlaps with the first point of the second output block. Hence, adding the two overlapping output blocks yields the total output as 2, -2, 2, 6, -2, 2, ... as shown in Fig. S10.6-9.

#### Overlap and Save Method

In this case, we augment the first block with 0 as its first digit. Hence, the first input blocks is 0, 1, -2, 3. For the second block, the first digit is the augmented digit, whose value is identical to the last digit of the first block. Thus, the second block is 3, 0, -1, 2. It can be readily verified that the Circular convolution of each of these two input blocks with the padded impulse response  $h[k] = \{2, 2, 0, 0\}$  results in output blocks  $y_1[k] = \{6, 2, -2, 2\}$  and  $y_2[k] = \{10, 6, -2, 2\}$ . The two blocks are added (after discarding the first  $M - 1 = 1$  digit of each output block as shown in Fig. S10.6-9. the final result is  $y[k] = \{2, -2, 2, 6, -2, 2, \dots\}$ .

We may also obtain this result using DFT procedure that follows.

Substituting the appropriate values of  $f[k]$ ,  $h[k]$ , and  $Y_r$  in the equations found in the first part, we obtain the first output block as  $\{0, 2, -2, 2\}$ , and the second output block as  $\{6, 6, -2, 2\}$ . When we discard the first point in both the output blocks, the saved data sequence is  $\{2, -2, 2, 6, -2, 2, \dots\}$

We can readily verify that the linear convolution of the input sequence  $f[k] = \{1, -2, 3, 0, -1, 2, \dots\}$  with  $h[k] = \{2, 2\}$  is indeed  $\{2, -2, 2, 6, -2, 2, \dots\}$ .

**10.6-10** In this case  $F_0 = F_1 = F_2 = F_{14} = F_{15} = 1$ . All other  $F_r = 0$ . Also  $\Omega_0 = \frac{\pi}{8}$ . Hence

$$\begin{aligned} f[k] &= \frac{1}{16} \sum_{r=0}^{15} F_r e^{jr\frac{\pi}{8}k} = \frac{1}{16} \left( 1 + e^{j\frac{\pi}{8}k} + e^{j\frac{\pi}{4}k} + e^{j\frac{3\pi}{8}k} + e^{j\frac{7\pi}{8}k} + e^{j\frac{9\pi}{8}k} + e^{j\frac{5\pi}{4}k} + e^{j\frac{11\pi}{8}k} + e^{j\frac{3\pi}{2}k} + e^{j\frac{13\pi}{8}k} + e^{j\frac{7\pi}{4}k} + e^{j\frac{15\pi}{8}k} \right) \\ &= \frac{1}{16} \left( 1 + e^{j\frac{\pi}{8}k} + e^{j\frac{\pi}{4}k} + e^{-j\frac{\pi}{4}k} + e^{-j\frac{\pi}{8}k} \right) \\ &= \frac{1}{16} \left[ 1 + 2 \cos \left( \frac{\pi}{8}k \right) + 2 \cos \left( \frac{\pi}{4}k \right) \right] \end{aligned}$$

From the above equation, we obtain  $F_0 = 0.3125$ ,  $F_1 = 0.2664$ ,  $F_2 = 0.1508$ ,  $F_3 = 0.0219$ ,  $F_4 = -0.0625, \dots$   
From Eq. 10.45

$$f[k] = \frac{1}{4} \text{sinc} \left( \frac{\pi k}{4} \right)$$

Hence  $F_0 = 0.25$ ,  $F_1 = 0.2251$ ,  $F_2 = 0.1591$ ,  $F_3 = 0.075$ ,  $F_4 = 0, \dots$

These values differ slightly from those obtained from the 16-point DFT because of aliasing. This is because the IDFT is a periodic extension of  $f[k]$  with a period 16. In this case,  $f[k]$  has infinite duration, and the cycles overlap. Hence, the resulting periodic extension in the first cycle is no longer  $f[k]$ , but  $\hat{f}[k]$  which is the aliased version of  $f[k]$  resulting from the overlap of various cycles. Longer the  $N_0$ , smaller the overlap, and closer the IDFT to  $f[k]$ .

# Chapter 11

---

11.1-1 (a)

$$\begin{aligned}
 F[z] &= \sum_{k=1}^{\infty} \gamma^{k-1} z^{-k} = \frac{1}{\gamma} \sum_{k=1}^{\infty} \left(\frac{\gamma}{z}\right)^k \\
 &= \frac{1}{\gamma} \left[ \frac{\gamma}{z} + \left(\frac{\gamma}{z}\right)^2 + \left(\frac{\gamma}{z}\right)^3 + \dots \right] \\
 &= \frac{1}{\gamma} \left[ -1 + \left(1 + \frac{\gamma}{z} + \left(\frac{\gamma}{z}\right)^2 + \left(\frac{\gamma}{z}\right)^3 + \dots \right) \right] \\
 &= \frac{1}{\gamma} \left[ -1 + \frac{1}{1 - \frac{\gamma}{z}} \right] = \frac{1}{z - \gamma}
 \end{aligned} \tag{1}$$

(b)

$$\begin{aligned}
 F[z] &= \sum_{k=m}^{\infty} z^{-k} = z^{-m} + z^{-(m+1)} + z^{-(m+2)} + \dots \\
 &= z^{-m} \left[ 1 + \frac{1}{z} + \frac{1}{z^2} + \dots \right] \\
 &= z^{-m} \left( \frac{1}{1 - \frac{1}{z}} \right) = \frac{z}{z^m(z-1)}
 \end{aligned}$$

(c)

$$F[z] = \sum_{k=0}^{\infty} \frac{\gamma^k}{k!} z^{-k} = \sum_{k=0}^{\infty} \frac{1}{k!} \left(\frac{\gamma}{z}\right)^k$$

Recall that

$$e^x = \sum_{k=0}^{\infty} \frac{1}{k!} x^k$$

Therefore

$$F[z] = e^{\gamma/z}$$

(d)

$$F[z] = \sum_{k=0}^{\infty} \frac{1}{k!} (\ln \alpha)^k z^{-k} = \sum_{k=0}^{\infty} \frac{1}{k!} \left(\frac{\ln \alpha}{z}\right)^k$$

From the result in part (c) it follows that

$$F[z] = e^{\ln \alpha / z} = (e^{\ln \alpha})^{1/z} = \alpha^{1/z}$$

11.1-2 (a)

$$f[k] = (2)^{k+1} u[k-1] + (e)^{k-1} u[k] = 4(2)^{k-1} u[k-1] + \frac{1}{e}(e)^k u[k]$$

Therefore

$$F[z] = \frac{4}{z-2} + \frac{1}{e} \frac{z}{z-e}$$

(b)

$$f[k] = k\gamma^k u[k-1] = k\gamma^k u[k] - 0 = k\gamma^k u[k]$$

Therefore



$$F[z] = \frac{\gamma z}{(z - \gamma)^2}$$

(c)

$$f[k] = [(2)^{-k} \cos \frac{\pi k}{3}] u[k-1] = (2)^{-k} \cos \frac{\pi k}{3} u[k] - \delta[k]$$

Therefore

$$F[z] = \frac{z(z-0.25)}{z^2-0.5z+0.25} - 1 = \frac{0.25(z-1)}{z^2-0.5z+0.25}$$

(d) Because  $k(k-1)(k-2) = 0$  for  $k = 0, 1,$  and  $2$

$$f[k] = k(k-1)(k-2)2^{k-3}u[k-m] = k(k-1)(k-2)(2)^{k-3}u[k]$$

$k = 0, 1,$  or  $2$ . Therefore

$$f[k] = (2)^{-3}\{k(k-1)(k-2)2^k u[k]\}$$

and

$$F[z] = (2)^{-3} \left[ \frac{3!(2)^3 z}{(z-2)^4} \right] = \frac{6z}{(z-2)^4}$$

11.1-3 (a)

$$\frac{F[z]}{z} = \frac{z-4}{(z-2)(z-3)} = \frac{2}{z-2} - \frac{1}{z-3}$$

$$F[z] = 2 \frac{z}{z-2} - \frac{z}{z-3}$$

$$f[k] = [2(2)^k - (3)^k] u[k]$$

(b)

$$\frac{F[z]}{z} = \frac{z-4}{z(z-2)(z-3)} = \frac{-2/3}{z} + \frac{1}{z-2} - \frac{1/3}{z-3}$$

$$F[z] = -\frac{2}{3} + \frac{z}{z-2} - \frac{1}{3} \frac{z}{z-3}$$

$$f[k] = -\frac{2}{3} \delta[k] + \left[ (2)^k - \frac{1}{3}(3)^k \right] u[k]$$

(c)

$$\frac{F[z]}{z} = \frac{e^{-2} - 2}{(z - e^{-2})(z - 2)} = \frac{1}{z - e^{-2}} - \frac{1}{z - 2}$$

$$F[z] = \frac{z}{z - e^{-2}} - \frac{z}{z - 2}$$

$$f[k] = [e^{-2k} - 2^k] u[k]$$

(d)

$$\frac{F[z]}{z} = \frac{2z+3}{(z-1)(z-2)(z-3)} = \frac{5/2}{z-1} - \frac{7}{z-2} + \frac{9/2}{z-3}$$

$$F[z] = \frac{5}{2} \frac{z}{z-1} - 7 \frac{z}{z-2} + \frac{9}{2} \frac{z}{z-3}$$

$$f[k] = \left[ \frac{5}{2} - 7(2)^k + \frac{9}{2}(3)^k \right] u[k]$$

(e)

$$\frac{F[z]}{z} = \frac{-5z+22}{(z+1)(z-2)^2} = \frac{3}{z+1} + \frac{k}{z-2} + \frac{4}{(z-2)^2}$$

Multiply both sides by  $z$  and let  $z \rightarrow \infty$ . This yields

$$0 = 3 + k + 0 \implies k = -3$$

$$F[z] = 3\frac{z}{z+1} - 3\frac{z}{z-2} + 4\frac{z}{(z-2)^2}$$

$$f[k] = [3(-1)^k - 3(2)^k + 2k(2)^k] u[k]$$

(f)

$$\frac{F[z]}{z} = \frac{1.4z + 0.08}{(z-0.2)(z-0.8)^2} = \frac{1}{z-0.2} + \frac{k}{z-0.8} + \frac{2}{(z-0.8)^2}$$

Multiply both sides by  $z$  and let  $z \rightarrow \infty$ . This yields

$$0 = 1 + k \implies k = -1$$

$$F[z] = \frac{z}{z-0.2} - \frac{z}{z-0.8} + 2\frac{z}{(z-0.8)^2}$$

$$f[k] = [(0.2)^k - (0.8)^k + \frac{5}{2}k(0.8)^k] u[k]$$

(g) We use pair 12c with  $A = 1$ ,  $B = -2$ ,  $a = -0.5$ ,  $|\gamma| = 1$ . Therefore

$$r = \sqrt{4} = 2 \quad \beta = \cos^{-1}\left(\frac{0.5}{1}\right) = \frac{\pi}{3} \quad \theta = \tan^{-1}\left(\frac{1}{\sqrt{3}}\right) = \frac{\pi}{3}$$

$$f[k] = 2(1)^k \cos\left(\frac{\pi k}{3} + \frac{\pi}{3}\right) u[k] = 2 \cos\left(\frac{\pi k}{3} + \frac{\pi}{3}\right) u[k]$$

(h)

$$\frac{F[z]}{z} = \frac{2z^2 - 0.3z + 0.25}{z(z^2 + 0.6z + 0.25)} = \frac{1}{z} + \frac{Az + B}{z^2 + 0.6z + 25}$$

Multiply both sides by  $z$  and let  $z \rightarrow \infty$ . This yields

$$2 = 1 + A \implies A = 1$$

Setting  $z = 1$  on both sides yields

$$\frac{1.95}{1.85} = 1 + \frac{1+B}{1.85} \implies B = -0.9$$

$$F[z] = 1 + \frac{z(z-0.9)}{z^2 + 0.6z + 0.25}$$

For the second fraction on right side, we use pair 12c with  $A = 1$ ,  $B = -0.9$ ,  $a = 0.3$ , and  $|\gamma| = 0.5$ . This yields

$$r = \sqrt{10} \quad \beta = \cos^{-1}\left(\frac{-0.3}{0.5}\right) = 2.214 \quad \theta = \tan^{-1}\left(\frac{1.2}{0.4}\right) = 1.249$$

$$f[k] = \delta[k] + \sqrt{10}(0.5)^k \cos(2.214k + 1.249) u[k]$$

(i)

$$\frac{F[z]}{z} = \frac{2(3z-23)}{(z-1)(z^2-6z+25)} = \frac{-2}{z-1} + \frac{Az+B}{z^2-6z+25}$$

Multiply both sides by  $z$  and let  $z \rightarrow \infty$ . This yields

$$0 = -2 + A \implies A = 2$$

Set  $z = 0$  on both sides to obtain

$$\frac{46}{25} = 2 + \frac{B}{25} \implies B = -4$$

$$F[z] = -2 + \frac{z}{z-1} + \frac{z(2z-4)}{z^2-6z+25}$$

For the second fraction on the right-hand side, we use pair 12c with  $A = 2$ ,  $B = -4$ ,  $a = -3$ , and  $|\gamma| = 5$ .

$$r = \frac{\sqrt{17}}{2} \quad \beta = \cos^{-1}\left(\frac{3}{5}\right) = 0.927 \quad \theta = \tan^{-1}\left(\frac{-1}{4}\right) = -0.25$$

$$f[k] = \left[ -2 + \frac{\sqrt{17}}{2}(5)^k \cos(0.927k - 0.25) \right] u[k]$$

(j)

$$\frac{F[z]}{z} = \frac{3.83z + 11.34}{(z-2)(z^2 - 5z + 25)} = \frac{1}{z-2} + \frac{Az + B}{z^2 - 5z + 25}$$

Multiply both sides by  $z$  and let  $z \rightarrow \infty$ . This yields

$$0 = 1 + A \implies A = -1$$

Setting  $z = 0$  on both sides yields

$$\frac{11.34}{-50} = -\frac{1}{2} + \frac{B}{25} \implies B = 6.83$$

$$F[z] = \frac{z}{z-2} + \frac{z(-z + 6.83)}{z^2 - 5z + 25}$$

For the second fraction on right-hand side, use pair 12c with  $A = -1$ ,  $B = 6.83$ ,  $a = -2.5$ , and  $|\gamma| = 5$ .

$$r = \sqrt{2} \quad \beta = \cos^{-1}(0.5) = \frac{\pi}{3} \quad \theta = \tan^{-1}\left(\frac{-4.33}{-4.33}\right) = -\frac{3\pi}{4}$$

$$f[k] = \left[ (2)^k + \sqrt{2}(5)^k \cos\left(\frac{\pi}{3}k - \frac{3\pi}{4}\right) \right] u[k]$$

(k)

$$\frac{F[z]}{z} = \frac{z(-2z^2 + 8z - 7)}{(z-1)(z-2)^3} = \frac{1}{z-1} + \frac{k_1}{z-2} + \frac{k_2}{(z-2)^2} + \frac{2}{(z-2)^3}$$

Multiply both sides by  $z$  and let  $z \rightarrow \infty$ . This yields

$$-2 = 1 + k_1 \implies k_1 = -3$$

Set  $z = 0$  on both sides to obtain

$$0 = -1 + \frac{3}{2} + \frac{k_2}{4} - \frac{1}{4} \implies k_2 = -1$$

$$F[z] = \frac{z}{z-1} - 3\frac{z}{z-2} - \frac{z}{(z-2)^2} + 2\frac{z}{(z-2)^3}$$

$$f[k] = \left[ 1 - 3(2)^k - \frac{k}{2}(2)^k + \frac{1}{4}k(k-1)(2)^k \right] u[k]$$

**11.1-4** Long division of  $2z^3 + 13z^2 + z$  by  $z^3 + 7z^2 + 2z + 1$  yields

$$F[z] = 2 - \frac{1}{z} + \frac{4}{z^2} + \dots$$

Therefore  $f[0] = 2$ ,  $f[1] = -1$ ,  $f[2] = 4$ .

**11.1-5**

$$F[z] = \frac{\gamma z}{z^2 - 2\gamma z + \gamma^2}$$

Long division yields

$$\frac{\gamma z}{z^2 - 2\gamma z + \gamma^2} = \frac{\gamma}{z} + 2\left(\frac{\gamma}{z}\right)^2 + 3\left(\frac{\gamma}{z}\right)^3 + \dots$$

Therefore  $f[0] = 0$ ,  $f[1] = \gamma$ ,  $f[2] = 2\gamma^2$ ,  $f[3] = 3\gamma^3, \dots$ , and

$$f[k] = k\gamma^k u[k]$$

**11.2-1**

$$f[k] = u[k] - u[k-m]$$

$$F[z] = \frac{z}{z-1} - z^{-m} \frac{z}{z-1} = \frac{1-z^{-m}}{1-z^{-1}}$$

11.2-2

$$f[k] = \delta[k-1] + 2\delta[k-2] + 3\delta[k-3] + 4\delta[k-4] + 3\delta[k-5] + 2\delta[k-6] + \delta[k-7]$$

Therefore

$$\begin{aligned} F[z] &= \frac{1}{z} + \frac{2}{z^2} + \frac{3}{z^3} + \frac{4}{z^4} + \frac{3}{z^5} + \frac{2}{z^6} + \frac{1}{z^7} \\ &= \frac{z^6 + 2z^5 + 3z^4 + 4z^3 + 3z^2 + 2z + 1}{z^7} \end{aligned}$$

Alternate Method:

$$\begin{aligned} f[k] &= k\{u[k] - u[k-5]\} + (-k+8)\{u[k-5] - u[k-9]\} \\ &= ku[k] - 2ku[k-5] + ku[k-9] + 8u[k-5] - 8u[k-9] \\ &= ku[k] - 2\{(k-5)u[k-5] + 5u[k-5]\} + (k-9)u[k-9] + 9u[k-9] + 8u[k-5] - 8u[k-9] \\ &= ku[k] - 2(k-5)u[k-5] + (k-9)u[k-9] - 2u[k-5] + u[k-9] \end{aligned}$$

Therefore

$$\begin{aligned} F[z] &= \frac{z}{(z-1)^2} - \frac{2z}{z^5(z-1)^2} + \frac{z}{z^9(z-1)^2} - \frac{2z}{z^5(z-1)} + \frac{z}{z^9(z-1)} \\ &= \frac{z}{z^9(z-1)^2} [z^9 - 2z^4 + 1 - 2z^4(z-1) + (z-1)] \\ &= \frac{1}{z^7(z-1)^2} [z^8 - 2z^4 + 1] \end{aligned}$$

Reader may verify that the two answers are identical.

11.2-3 (a)

$$f[k] = k^2 \gamma^k u[k]$$

Repeated application of Eq. (11.22) to  $\gamma^k u[k] \iff \frac{z}{z-\gamma}$  yields

$$\begin{aligned} k\gamma^k u[k] &\iff \frac{\gamma z}{(z-\gamma)^2} \\ k^2 \gamma^k u[k] &\iff \frac{\gamma z(z+\gamma)}{(z-\gamma)^3} \end{aligned}$$

(b) In the above result, letting  $\gamma = 1$  yields  $k^2 u[k] \iff \frac{z(z+1)}{(z-1)^3}$ . Application of Eq. (11.22) to this result yields

$$k^3 u[k] = -z \frac{d}{dz} \left[ \frac{z(z+1)}{(z-1)^3} \right] = \frac{z(z^2 + 4z + 1)}{(z-1)^4}$$

(c)

$$\begin{aligned} f[k] &= a^k \{u[k] - u[k-m]\} \\ &= a^k u[k] - a^m a^{(k-m)} u[k-m] \\ F[z] &= \frac{z}{z-a} - \frac{a^m z}{z-a} z^{-m} = \frac{z}{z-a} \left[ 1 - \left( \frac{a}{z} \right)^m \right] \end{aligned}$$

(d)

$$\begin{aligned} f[k] &= ke^{-2k} u[k-m] = (k-m+m)e^{-2(k-m+m)} u[k-m] \\ &= e^{-2m}(k-m)e^{-2(k-m)} u[k-m] + me^{-2m} e^{-2(k-m)} u[k-m] \\ F[z] &= e^{-2m} \frac{e^{-2z}}{(z-e^{-2})^2} z^{-2} + me^{-2m} \left( \frac{z}{z-e^{-2}} \right) z^{-2} \\ &= \frac{e^{-2m}}{z(z-e^{-2})^2} \left[ \frac{1}{e^2} (1-m) + mz \right] \end{aligned}$$

11.2-4 Pair2:

$$u[k] = \delta[k] + \delta[k-1] + \delta[k-2] + \delta[k-3] + \dots$$

$$u[k] \iff 1 + \frac{1}{z} + \frac{1}{z^2} + \frac{1}{z^3} + \dots = \frac{1}{1 - \frac{1}{z}} = \frac{z}{z-1}$$

Repeated application of Eq. (11.22) to pair 2 yields pair 3, 4, and 5.

Application of Eq. (11.21) to pair 2 yields pair 7, and application of time-delay (11.16a) to pair 7 yields pair 6.

Repeated application of Eq. (11.22) to pair 7 yields pair 8 and 9.

### 11.3-1

$$y[k+1] - \gamma y[k] = f[k+1]$$

with  $y[0] = -M$ ,  $f[k] = Pu[k-1]$

$$F[z] = \frac{P}{z-1}$$

$$y[k] \iff Y[z] \quad y[k+1] \iff zY[z] + Mz$$

The  $z$ -transform of the system equation is

$$\begin{aligned} zY[z] + Mz - \gamma Y[z] &= \frac{Pz}{z-1} \\ (z-\gamma)Y[z] &= -M + \frac{Pz}{z-1} \end{aligned}$$

and

$$\begin{aligned} Y[z] &= \frac{-Mz}{z-\gamma} + \frac{Pz}{(z-\gamma)(z-1)} \\ \frac{Y[z]}{z} &= \frac{-M}{z-\gamma} + \frac{P}{(z-\gamma)(z-1)} = \frac{-M}{z-\gamma} + \frac{P}{\gamma-1} \left[ \frac{1}{z-\gamma} - \frac{1}{z-1} \right] \\ Y[z] &= -M \frac{z}{z-\gamma} + \frac{P}{\gamma-1} \left[ \frac{z}{z-\gamma} - \frac{z}{z-1} \right] \\ y[k] &= \left[ -M\gamma^k + \frac{P(\gamma^k-1)}{r} \right] u[k] \quad r = \gamma - 1 \end{aligned}$$

The loan balance is zero for  $k = N$ , that is,  $y[N] = 0$ . Setting  $k = N$  in the above equation we obtain

$$y[N] = \left[ -M\gamma^N + \frac{P(\gamma^N-1)}{r} \right] = 0$$

This yields

$$P = \frac{r\gamma^N}{\gamma^N - 1} M$$

### 11.3-2 The $z$ -transform of the equation yields

$$zY[z] - z + 2Y[z] = zF[z] - zf(0)$$

$$f[k] = ee^{-k}u[k] \quad \text{and} \quad F[z] = \frac{ez}{z-e^{-1}}, \quad f[0] = e$$

Therefore

$$\begin{aligned} (z+2)Y[z] &= z - ez + \frac{ez^2}{z-e^{-1}} = \frac{z(1-e)(z-e^{-1}) + ez^2}{z-e^{-1}} \\ \frac{Y[z]}{z} &= \frac{z+1-e^{-1}}{(z+2)(z-e^{-1})} = \frac{1}{2e+1} \left[ \frac{e+1}{z+2} + \frac{e}{z-e^{-1}} \right] \\ Y[z] &= \frac{1}{2e+1} \left[ (e+1) \frac{z}{z+2} + e \frac{z}{z-e^{-1}} \right] \\ y[k] &= \frac{1}{2e+1} \left[ (e+1)(-2)^k + e^{-(k-1)} \right] u[k] \end{aligned}$$

### 11.3-3 The system equation in delay form is

$$2y[k] - 3y[k-1] + y[k-2] = 4f[k] - 3f[k-1]$$

Also

$$\begin{aligned} y[k] &\iff Y[z] & y[k-1] &\iff \frac{1}{z}Y[z] & y[k-2] &\iff \frac{1}{z^2}Y[z] + 1 \\ f[k] &\iff F[z] = \frac{z}{z-0.25} & f[k-1] &\iff \frac{1}{z-0.25} \end{aligned}$$

The  $z$ -transform of the equation is

$$2Y[z] - \frac{3}{z}Y[z] + \frac{1}{z^2}Y[z] + 1 = \frac{4z}{z-0.25} - \frac{3}{z-0.25} = \frac{4z-3}{z-0.25}$$

or

$$\left(2 - \frac{3}{z} + \frac{1}{z^2}\right)Y[z] = -1 + \frac{4z-3}{z-0.25} = \frac{3z-2.75}{z-0.25}$$

and

$$\begin{aligned} \frac{Y[z]}{z} &= \frac{z(3z-2.75)}{(2z^2-3z+1)(z-0.25)} = \frac{z(3z-2.75)}{2(z-0.5)(z-1)(z-0.25)} = \frac{5/2}{z-1/2} + \frac{1/3}{z-1} - \frac{4/3}{z-0.25} \\ y[k] &= \left[\frac{1}{3} + \frac{5}{2}(0.5)^k - \frac{4}{3}(0.25)^k\right]u[k] = \left[\frac{1}{3} + \frac{5}{2}(2)^{-k} - \frac{4}{3}(4)^{-k}\right]u[k] \end{aligned}$$

**11.3-4** For initial conditions  $y[0], y[1]$ , we require equation in advance form:

$$2y[k+2] - 3y[k+1] + y[k] = 4f[k+2] - 3f[k+1]$$

Also

$$\begin{aligned} y[k] &\iff Y[z] & y[k+1] &\iff zY[z] - \frac{3}{2}z & y[k+2] &\iff z^2Y[z] - \frac{3}{2}z^2 - \frac{35}{4}z \\ f[k] &\iff F[z] = \frac{z}{z-0.25} & f[k+1] &\iff zF[z] - z = \frac{0.25z}{z-0.25} \end{aligned}$$

and

$$f[k+2] \iff z^2F[z] - z^2 - \frac{1}{4}z = \frac{z}{16(z-0.25)}$$

The  $z$ -transform of the equation is

$$2\left[z^2Y[z] - \frac{3}{2}z^2 - \frac{35}{4}z\right] - 3\left[zY[z] - \frac{3}{2}z\right] + Y[z] = \frac{-z/2}{z-0.25}$$

or

$$(2z^2 - 3z + 1)Y[z] = \frac{z(3z^2 + 12.25z - 3.75)}{(z-0.25)}$$

and

$$\begin{aligned} \frac{Y[z]}{z} &= \frac{3z^2 + 12.25z - 3.75}{2(z-0.25)(z-1)(z-0.5)} = \frac{46/3}{z-1} - \frac{4/3}{z-0.25} - \frac{25/2}{z-0.5} \\ Y[z] &= \frac{46}{3} \frac{z}{z-1} - \frac{4}{3} \frac{z}{z-0.25} - \frac{25}{2} \frac{z}{z-0.5} \\ y[k] &= \left[\frac{46}{3} - \frac{4}{3}(0.25)^k - \frac{25}{2}(0.5)^k\right]u[k] \end{aligned}$$

**11.3-5** System equation in delay form is

$$4y[k] + 4y[k-1] + y[k-2] = f[k-1]$$

Also

$$\begin{aligned} y[k] &\iff Y[z] & y[k-1] &\iff \frac{1}{z}Y[z] & y[k-2] &\iff \frac{1}{z^2}Y[z] + 1 \\ f[k] &\iff \frac{z}{z-1} & f[k-1] &\iff \frac{1}{z-1} & (f[-1] = 0) \end{aligned}$$

The  $z$ -transform of the system equation is

$$4Y[z] + \frac{4}{z}Y[z] + \frac{1}{z^2}Y[z] + 1 = \frac{1}{z-1}$$

$$\frac{4z^2 + 4z + 1}{z^2}Y[z] = \frac{2-z}{z-1}$$

and

$$\frac{Y[z]}{z} = \frac{z(2-z)}{4(z-1)(z^2+z+0.25)} = \frac{z(2-z)}{4(z-1)(z+0.5)^2} = \frac{1}{4} \left[ \frac{4/9}{z-1} - \frac{13/9}{z+0.5} + \frac{5/6}{(z+0.5)^2} \right]$$

$$Y[z] = \frac{1}{4} \left[ \frac{4}{9} \frac{z}{z-1} - \frac{13}{9} \frac{z}{z+0.5} + \frac{5}{6} \frac{z}{(z+0.5)^2} \right]$$

$$y[k] = \left[ \frac{1}{9} - \frac{13}{36}(-0.5)^k - \frac{5}{12}k(-0.5)^k \right] u[k]$$

11.3-6 The system in delay form is

$$y[k] - 3y[k-1] + 2y[k-2] = f[k-1]$$

Also

$$y[k] \iff Y[z] \quad y[k-1] \iff \frac{1}{z}Y[z] + 2 \quad y[k-2] \iff \frac{1}{z^2}Y[z] + \frac{2}{z} + 3$$

$$f[k] \iff F[z] \quad f[k-1] \iff \frac{1}{z}F[z]$$

$$F[z] = \frac{z}{z-3}$$

The  $z$ -transform of the system equation is

$$Y[z] - 3 \left[ \frac{1}{z}Y[z] + 2 \right] + 2 \left[ \frac{1}{z^2}Y[z] + \frac{2}{z} + 3 \right] = \frac{1}{z-3}$$

$$\left( 1 - \frac{3}{z} + \frac{2}{z^2} \right) Y[z] = -\frac{4}{z} + \frac{1}{z-3} = \frac{-3z+12}{z(z-3)}$$

$$\frac{Y[z]}{z} = \frac{-3z+12}{(z^2-3z+2)(z-3)} = \frac{-3z+12}{(z-1)(z-2)(z-3)} = \frac{9/2}{z-1} - \frac{6}{z-2} + \frac{3/2}{z-3}$$

$$Y[z] = \frac{9}{2} \frac{z}{z-1} - 6 \frac{z}{z-2} + \frac{3}{2} \frac{z}{z-3}$$

$$y[k] = \left[ \frac{9}{2} - 6(2)^k + \frac{3}{2}(3)^k \right] u[k]$$

11.3-7 The system equation in delay form is

$$y[k] - 2y[k-1] + 2y[k-2] = f[k-2]$$

$$y[k] \iff Y[z] \quad y[k-1] \iff \frac{1}{z}Y[z] + 1 \quad y[k-2] \iff \frac{1}{z^2}Y[z] + \frac{1}{z}$$

$$f[k-2] \iff \frac{1}{z^2}F[z] \quad \text{and} \quad F[z] = \frac{z}{z-1}$$

The  $z$ -transform of the difference equation is

$$Y[z] - 2 \left[ \frac{1}{z}Y[z] + 1 \right] + 2 \left[ \frac{1}{z^2}Y[z] + \frac{1}{z} \right] = \frac{1}{z(z-1)}$$

$$\frac{(z^2-2z+2)}{z^2}Y[z] = \frac{2z^2-4z+3}{z(z-1)}$$

$$\frac{Y[z]}{z} = \frac{2z^2 - 4z + 3}{(z-1)(z^2 - 2z + 2)} = \frac{1}{z-1} + \frac{z-1}{z^2 - 2z + 2}$$

$$Y[z] = \frac{z}{z-1} + \frac{z(z-1)}{z^2 - 2z + 2}$$

For the second fraction on the right-hand side, we use pair 12c with  $A = 1$ ,  $B = -1$ ,  $a = -1$ ,  $|\gamma|^2 = 2$ . This yields  $r = 1$ ,  $\beta = \frac{\pi}{4}$ , and  $\theta = 0$ . Therefore

$$y[k] = [1 + (\sqrt{2})^k \cos(\frac{\pi}{4}k)] u[k]$$

**11.3-8** The equation in advance form is

$$y[k+2] + 2y[k+1] + 2y[k] = f[k+1] + 2f[k]$$

$$y[k] \iff Y[z] \quad y[k+1] \iff zY[z] \quad y[k+2] \iff z^2Y[z] - z$$

$$f[k] \iff F[z] \quad f[k+1] \iff zF[z] - z \quad \text{and} \quad F[z] = \frac{z}{z-e}$$

The  $z$ -transform of the difference equation is

$$z^2Y[z] - z + 2zY[z] + 2Y[z] = \frac{z^2}{z-e} - z + \frac{2z}{z-e} = \frac{z(e+2)}{z-e}$$

$$(z^2 + 2z + 2)Y[z] = z + \frac{z(e+2)}{z-e} = \frac{z(z+2)}{z-e}$$

Therefore

$$\frac{Y[z]}{z} = \frac{z+2}{(z-e)(z^2+2z+2)} = \frac{0.318}{z-e} + \frac{-0.318z-0.502}{z^2+2z+2}$$

$$Y[z] = 0.318 \frac{z}{z-e} - \frac{z(0.318z+0.502)}{z^2+2z+2}$$

For the second fraction on the right-hand side, we use pair 12c with  $A = 0.318$ ,  $B = 0.502$ ,  $a = 1$ ,  $|\gamma|^2 = 2$  and

$$r = 0.367 \quad \beta = \cos^{-1}\left(\frac{-1}{\sqrt{2}}\right) = \frac{3\pi}{4} \quad \theta = \tan^{-1}\left(\frac{-0.184}{0.318}\right) = -0.525$$

$$y[k] = [0.318(e)^k - 0.367(\sqrt{2})^k \cos(\frac{3\pi}{4}k - 0.525)] u[k]$$

**11.3-9**

$$f[k] = ee^k u[k] \quad F[z] = \frac{ez}{z-e}$$

$$Y[z] = F[z]H[z] = \frac{ez^2}{(z-e)(z+0.2)(z-0.8)}$$

Therefore

$$\frac{Y[z]}{z} = \frac{ez}{(z-e)(z+0.2)(z-0.8)} = \frac{1.32}{z-e} - \frac{0.186}{z+0.2} - \frac{1.13}{z-0.8}$$

$$Y[z] = 1.32 \frac{z}{z-e} - 0.186 \frac{z}{z+0.2} - 1.13 \frac{z}{z-0.8}$$

$$y[k] = [1.32(e)^k - 0.186(-0.2)^k - 1.13(0.8)^k] u[k]$$

**11.3-10**

$$Y[z] = F[z]H[z] = \frac{z(2z+3)}{(z-1)(z-2)(z-3)}$$

Therefore

$$\frac{Y[z]}{z} = \frac{2z+3}{(z-1)(z-2)(z-3)} = \frac{5/2}{z-1} - \frac{7}{z-2} + \frac{9/2}{z-3}$$

$$Y[z] = \frac{5}{2} \frac{z}{z-1} - 7 \frac{z}{z-2} + \frac{9}{2} \frac{z}{z-3}$$

$$y[k] = \left[ \frac{5}{2} - 7(2)^k + \frac{9}{2}(3)^k \right] u[k]$$



11.3-11 (a)  $f[k] = 4^{-k}u[k] = (\frac{1}{4})^k u[k]$  so that  $F[z] = \frac{z}{z-\frac{1}{4}}$ , and

$$Y[z] = F[z]H[z] = \frac{6z(5z-1)}{(z-\frac{1}{4})(6z^2-5z+1)} = \frac{z(5z-1)}{(z-\frac{1}{4})(z-\frac{1}{3})(z-\frac{1}{2})}$$

Therefore

$$\begin{aligned} \frac{Y[z]}{z} &= \frac{5z-1}{(z-\frac{1}{4})(z-\frac{1}{3})(z-\frac{1}{2})} = \frac{12}{z-\frac{1}{4}} - \frac{48}{z-\frac{1}{3}} + \frac{36}{z-\frac{1}{2}} \\ Y[z] &= 12\frac{z}{z-\frac{1}{4}} - 48\frac{z}{z-\frac{1}{3}} + 36\frac{z}{z-\frac{1}{2}} \\ y[k] &= [12(\frac{1}{4})^k - 48(\frac{1}{3})^k + 36(\frac{1}{2})^k] u[k] \\ &= 12[4^{-k} - 4(3)^{-k} + 3(2)^{-k}] u[k] \end{aligned}$$

(b) Here the input is  $4^{-(k-2)}u[k-2]$  which is identical to the input in part (a) delayed by 2 units. Therefore the response will be the output in part (a) delayed by 2 units (time-invariance property). Therefore

$$y[k] = 12[4^{-(k-2)} - 4(3)^{-(k-2)} + 3(2)^{-(k-2)}] u[k-2]$$

(c) Here the input can be expressed as

$$f[k] = 4^{-(k-2)}u[k] = 16(4)^{-k}u[k]$$

This input is 16 times the input in part (a). Therefore the response will be 16 times the output in part (a) (linearity property). Therefore

$$y[k] = 192[4^{-k} - 4(3)^{-k} + 3(2)^{-k}] u[k]$$

(d) Here the input can be expressed as

$$f[k] = 4^{-k}u[k-2] = \frac{1}{16}(4)^{-(k-2)}u[k-2]$$

This input is  $\frac{1}{16}$  times the input in part (b). Therefore the response will be  $\frac{1}{16}$  times the output in part (b). Therefore

$$y[k] = \frac{3}{4}[4^{-(k-2)} - 4(3)^{-(k-2)} + 3(2)^{-(k-2)}] u[k-2]$$

11.3-12

$$Y[z] = F[z]H[z] = \frac{z(2z-1)}{(z-1)(z^2-1.6z+0.8)}$$

$$\frac{Y[z]}{z} = \frac{2z-1}{(z-1)(z^2-1.6z+0.8)} = \frac{5}{z-1} - \frac{5(z-1)}{z^2-1.6z+0.8}$$

$$Y[z] = 5\frac{z}{z-1} - 5\frac{z(z-1)}{z^2-1.6z+0.8}$$

For the second fraction on the right-hand side, we use pair 12c with  $A = 1$ ,  $B = -1$ ,  $a = -0.8$ ,  $\gamma = \frac{2}{\sqrt{5}}$ ,  $|\gamma|^2 = 0.8$ . Therefore

$$r = 1.118 \quad \beta = \cos^{-1}\left(\frac{0.8\sqrt{5}}{2}\right) = 0.464 \quad \theta = \tan^{-1}\left(\frac{0.2}{0.4}\right) = 0.464$$

$$\begin{aligned} y[k] &= \left[5 - 5(1.118)\left(\frac{2}{\sqrt{5}}\right)^k \cos(0.464k + 0.464)\right] u[k] \\ &= \left[5 - 5.59\left(\frac{2}{\sqrt{5}}\right)^k \cos(0.464k + 0.464)\right] u[k] \end{aligned}$$

11.3-13 (a)  $H[z] = \frac{z}{z+2}$  (b)  $H[z] = \frac{4z^2-3z}{2z^2-3z+1}$  (c)  $H[z] = \frac{z}{4z^2+4z+1}$  (d) We convert the equation to advanced operator form. This yields  $(E^2 + 2E + 2)y[k] = (E + 2)f[k]$ . Hence,  $H[z] = \frac{z+2}{z^2+2z+2}$

11.3-14 (a)

$$H[z] = \frac{z^2 + 3z + 3}{z^2 + 3z + 2} = \frac{z^2 + 3z + 3}{(z+1)(z+2)}$$

Therefore

$$\begin{aligned} \frac{H[z]}{z} &= \frac{z^2 + 3z + 3}{z(z+1)(z+2)} = \frac{3/2}{z} - \frac{1}{z+1} + \frac{1/2}{z+2} \\ H[z] &= \frac{3}{2} - \frac{z}{z+1} + \frac{1}{2} \frac{z}{z+2} \\ h[k] &= \left[ \frac{3}{2} \delta[k] - (-1)^k + \frac{1}{2} (-2)^k \right] u[k] \end{aligned}$$

(b)

$$H[z] = \frac{2z^2 - z}{z^2 + 2z + 1} = \frac{z(2z - 1)}{(z+1)^2}$$

Therefore

$$\begin{aligned} \frac{H[z]}{z} &= \frac{2z - 1}{(z+1)^2} = \frac{2}{z+1} - \frac{3}{(z+1)^2} \\ H[z] &= 2\left(\frac{z}{z+1}\right) - 3\frac{z}{(z+1)^2} \\ h[k] &= \left[ 2(-1)^k + 3k(-1)^k \right] u[k] = (2 + 3k)(-1)^k u[k] \end{aligned}$$

(c)

$$H[z] = \frac{z^2 + 2z}{z^2 - z + 0.5} = \frac{z(z+2)}{z^2 - z + 0.5}$$

Therefore

$$\frac{H[z]}{z} = \frac{z+2}{z^2 - z + 0.5}$$

We use pair 12c with  $A = 1$ ,  $B = 2$ ,  $a = -0.5$ ,  $|\gamma|^2 = 0.5$ ,  $|\gamma| = \frac{1}{\sqrt{2}}$ , and

$$r = 5.099 \quad \beta = \cos^{-1}(0.5\sqrt{5}) = \frac{\pi}{4} \quad \theta = \tan^{-1}\left(\frac{-2.5}{0.5}\right) = -1.373$$

$$h[k] = 5.099 \left(\frac{1}{\sqrt{2}}\right)^k \cos\left(\frac{\pi}{4} - 1.373\right) u[k]$$

11.3-15 (a)

$$\begin{aligned} \frac{H[z]}{z} &= \frac{1}{(z+0.2)(z-0.8)} = \frac{-1}{z+0.2} + \frac{1}{z-0.8} \\ H[z] &= -\frac{z}{z+0.2} + \frac{z}{z-0.8} \\ h[k] &= \left[ -(-0.2)^k + (0.8)^k \right] u[k] \end{aligned}$$

(b)

$$\begin{aligned} \frac{H[z]}{z} &= \frac{2z+3}{z(z-2)(z-3)} = \frac{1/2}{z} - \frac{7/2}{z-2} + \frac{3}{z-3} \\ H[z] &= \frac{1}{2} - \frac{7}{2} \frac{z}{z-2} + 3 \frac{z}{z-3} \\ h[k] &= \left[ \frac{1}{2} \delta[k] - \frac{7}{2} (2)^k + 3(3)^k \right] u[k] \end{aligned}$$

(c)

$$\frac{H[z]}{z} = \frac{2z-1}{z(z^2-1.6z+0.8)} = \frac{-1.25}{z} + \frac{1.25z}{z^2-1.6z+0.8}$$

For the second fraction on the right-hand side,  $A = 1.25$ ,  $B = 0$ ,  $a = -0.8$ ,  $|\gamma|^2 = 0.8$ ,  $|\gamma| = \frac{2}{\sqrt{5}}$ , and

$$r = 2.795 \quad \beta = \cos^{-1}\left(\frac{0.8\sqrt{5}}{2}\right) = 0.464 \quad \theta = \tan^{-1}(-2) = -1.107$$

$$h[k] = -1.25\delta[k] + 2.795\left(\frac{2}{\sqrt{5}}\right)^k \cos(0.464k - 1.107)u[k]$$

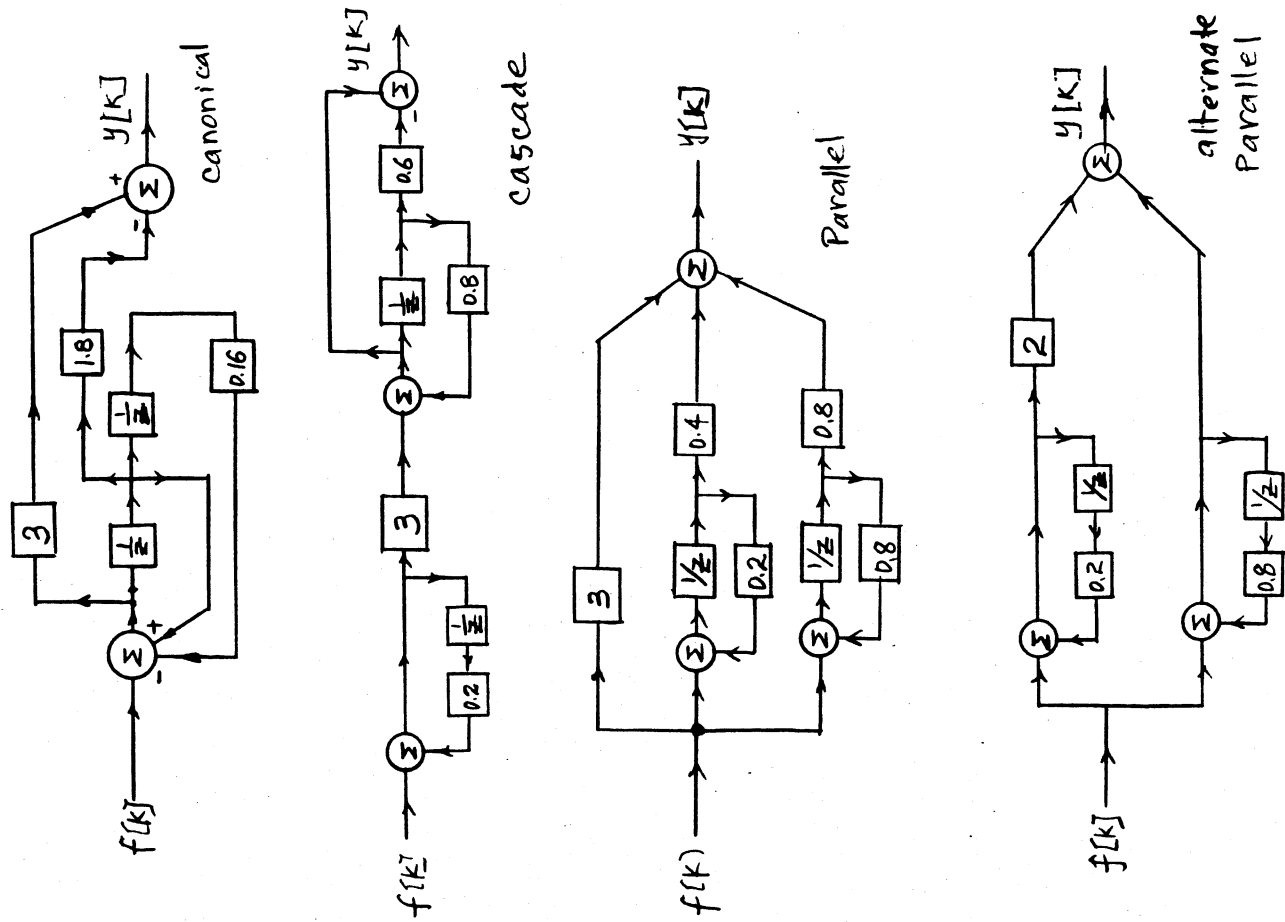

Figure S11.4-1a

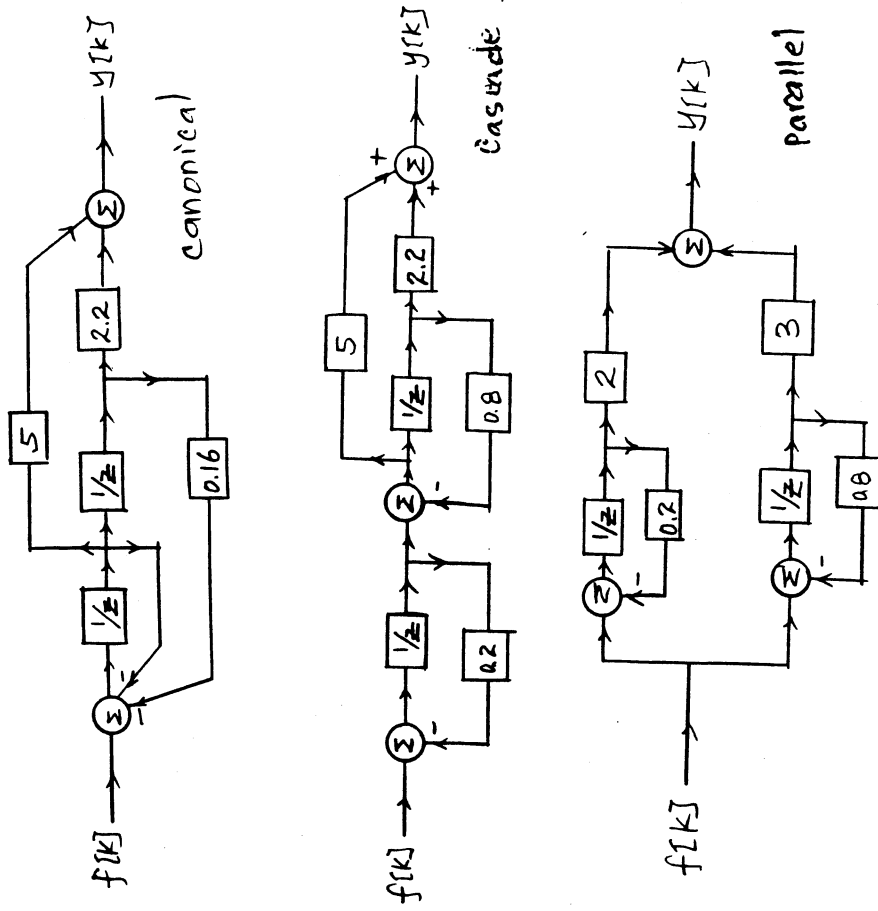

Figure S11.4-1b

11.4-1 (a)

$$H[z] = \frac{3z^2 - 1.8z}{z^2 - z + 0.16} = \frac{3z(z - 0.6)}{(z - 0.2)(z - 0.8)} = \left(\frac{3z}{z - 0.2}\right) \left(\frac{z - 0.6}{z - 0.8}\right)$$

Parallel form: To realize parallel form, we could expand  $H[z]$  or  $H[z]/z$  into partial fractions. In our case:

$$H[z] = 3 + \frac{1.2z - 0.48}{(z - 0.2)(z - 0.8)}$$

$$H[z] = 3 + \frac{0.4}{(z - 0.2)} + \frac{0.8}{(z - 0.8)}$$

Alternatively we could expand  $H[z]/z$  into partial fractions as:

$$\frac{H[z]}{z} = \frac{3(z - 0.6)}{(z - 0.2)(z - 0.8)} = \frac{2}{z - 0.2} + \frac{1}{z - 0.8}$$

and

$$H[z] = 2\frac{z}{z - 0.2} + \frac{z}{z - 0.8}$$

The realizations are shown in Fig. S11.4-1a.

(b)

$$\begin{aligned} H[z] &= \frac{5z + 2.2}{(z + 0.2)(z + 0.8)} = \frac{5z + 2.2}{z^2 + z + 0.16} \\ &= \left(\frac{1}{z + 0.2}\right) \left(\frac{5z + 2.2}{z + 0.8}\right) = \frac{2}{z + 0.2} + \frac{3}{z + 0.8} \end{aligned}$$

All the realizations are shown in Fig. S11.4-1b.

(c)

$$H[z] = \frac{3.8z - 1.1}{z^3 - 0.8z^2 + 0.37z - 0.05}$$

For a cascade form, we express  $H[z]$  as:

$$H[z] = \left(\frac{1}{z - 0.2}\right) \left(\frac{3.8z - 1.1}{z^2 - 0.6z + 0.25}\right)$$

For a parallel form, we express  $H[z]$  as:

$$H[z] = \frac{-2}{z - 0.2} + \frac{2z + 3}{z^2 - 0.6z + 0.25}$$

All the realizations are shown in Fig. S11.4-1c.

11.4-2. Note: the complex conjugate poles must be realized together as a second order factor

(a) Cascade form:

$$H[z] = \left(\frac{z}{z - 0.2}\right) \left(\frac{1.6z - 1.8}{z^2 + z + 0.5}\right)$$

Parallel form:

$$H[z] = \frac{-2z}{z - 0.2} + \frac{2z^2 + 4z}{z^2 + z + 0.5}$$

(b) Cascade form:

$$H[z] = \left(\frac{z}{z + 0.5}\right) \left(\frac{2z^2 + 1.3z + 0.96}{z^2 - 0.8z + 0.16}\right)$$

Parallel form:

$$H[z] = \frac{z}{z + 0.5} + \frac{z}{z - 0.4} + \frac{2z}{(z - 0.4)^2}$$

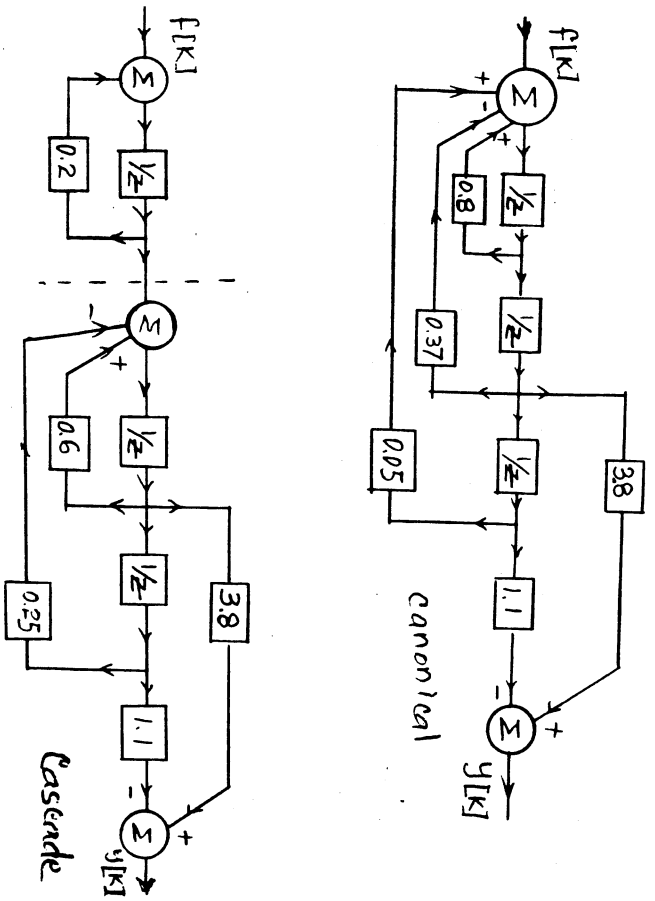
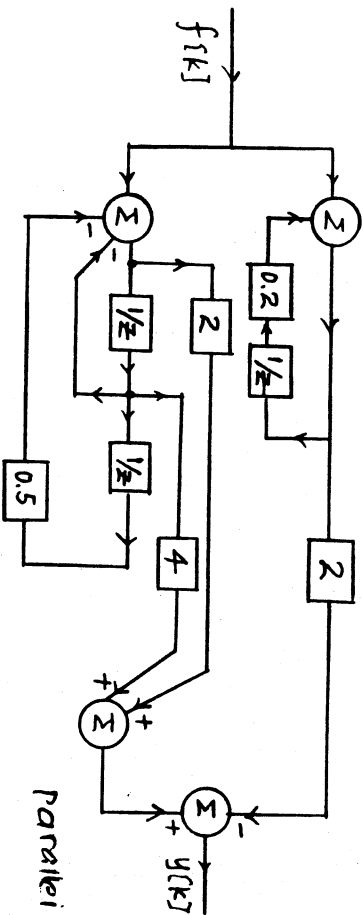
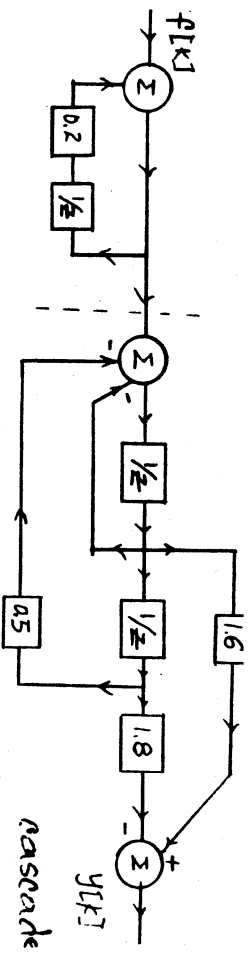
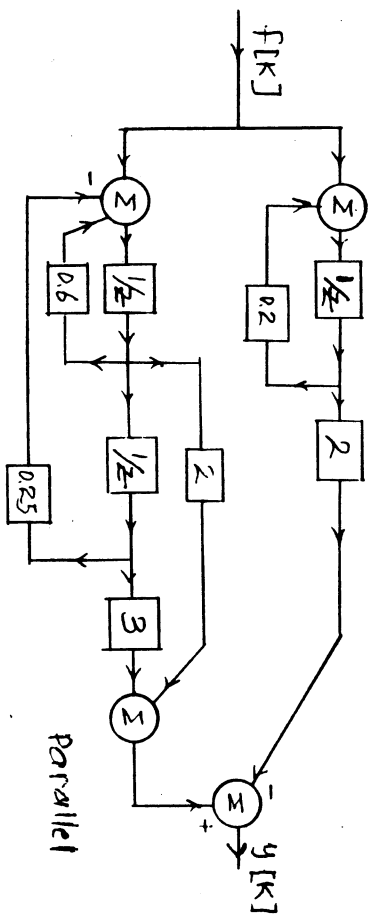

Figure S5.4-2 a



parallel



parallel

Figure S11.4-1c

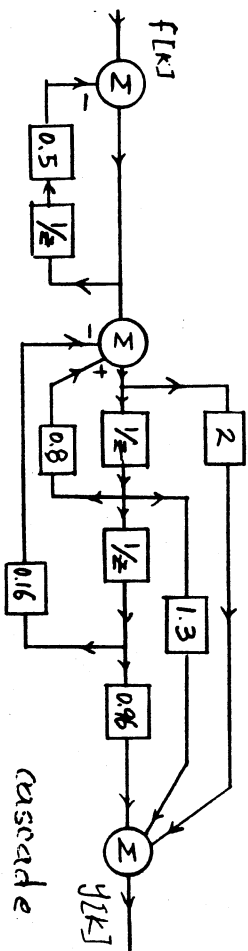

cascade

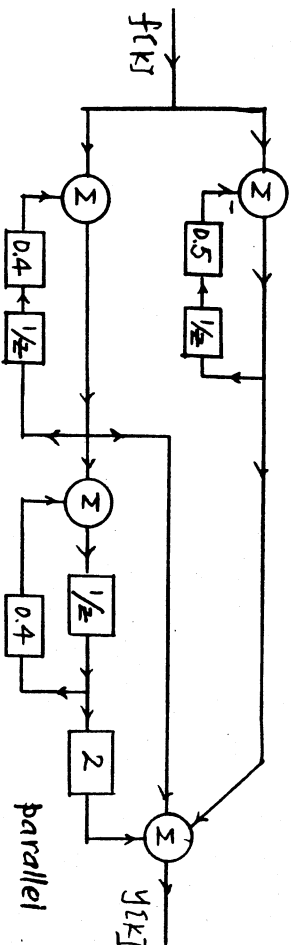

parallel

Figure S11.4-2-b

11.4-3.

$$H[z] = 2 + \frac{1}{z} + \frac{0.8}{z^2} + \frac{2}{z^3} + \frac{8}{z^4} = \frac{2z^2 + z^3 + 0.8z^2 + 2z + 8}{z^4}$$

The realization of this transfer function is shown in Fig. S11.4-3. It can be explained in two ways. The realization has 5 paths in parallel, and each path represents one term in the transfer function. The first path (which bypasses all the delays) has transfer function 2. The second path (going through only one delay) has transfer function  $1/z$ , and so on. Alternately we observe that this transfer function has  $a_0 = a_1 = a_2 = a_3 = 0$ , and  $b_0 = 8, b_1 = 2, b_2 = 0.8, b_3 = 1, b_4 = 2$ . Therefore all the feedback coefficients are zero, and there are no feedback paths. There are 4 feedforward paths with gains 8, 2, 0.8, 1, and 2 as shown in the realization.

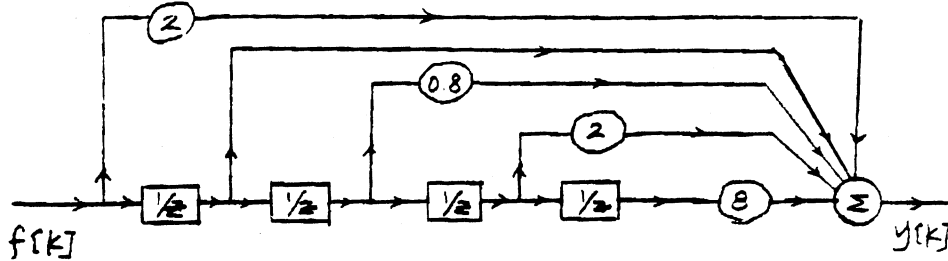

Figure S11.4-3

11.4-4

$$H[z] = \frac{1}{z} + \frac{2}{z^2} + \frac{3}{z^3} + \frac{4}{z^4} + \frac{5}{z^5} + \frac{6}{z^6}$$

This transfer function is similar to that in Prob. 11.4-3. Its realization is shown in Fig. S11.4-4.

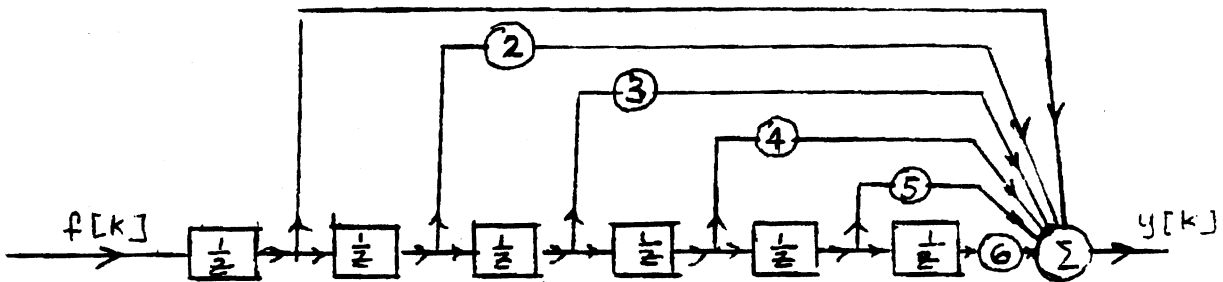

Figure S11.4-4

11.6-1 In this case,  $Y[z] = F[z]G[z]$ , where we use Table 12.1 to find  $F[z] = \frac{z}{z-e^{-2T}}$  and  $G[z] = \frac{z}{z-e^{-T}}$ . Hence,

$$\begin{aligned} Y[z] &= \frac{z^2}{(z-e^{-T})(z-e^{-2T})} \\ &= \frac{1}{1-e^{-T}} \left[ \frac{z}{z-e^{-T}} - e^{-T} \frac{z}{z-e^{-2T}} \right] \end{aligned}$$

Therefore

$$y[k] = \frac{1}{1-e^{-T}} [e^{-kT} - e^{-T(2k+1)}] u[k]$$

11.6-2 We can express  $E[z]$  as a sum of two signals; the input and the signal fed back. Thus

$$-E[z] = F[z] - GH[z]E[z]$$

Hence

$$E[z] = \frac{1}{1+GH[z]} F[z]$$

and

$$\begin{aligned}
 Y[z] &= G[z]E[z] \\
 &= \frac{G[z]}{1+GH[z]} F[z]
 \end{aligned}$$

Therefore

$$T[z] = \frac{Y[z]}{F[z]} = \frac{G[z]}{1+GH[z]}$$

**11.6-3** Here,  $Y[z]$  (the output of the dotted sampler) has two components: (1) due to input  $F[z]$ , and (2) the component resulting from the feedback of  $Y[z]$ . Hence

$$Y[z] = FG[z] - GH[z]Y[z]$$

and

$$Y[z] = \frac{FG[z]}{1+GH[z]}$$

We cannot separate  $F[z]$  from  $FG[z]$ . Hence, it is not possible to write the  $z$ -transfer function relating  $y[k]$  to  $f[k]$ . Analysis and synthesis of such systems involving only one sampler, which is located in the feedback path is little more difficult.

**11.7-1 (a)**

$$f[k] = \underbrace{(0.8)^k u[k]}_{f_1[k]} + \underbrace{2^k u[-(k+1)]}_{f_2[k]}$$

$$f_1[k] \iff \frac{z}{z-0.8} \quad |z| > 0.8$$

$$f_2[k] \iff \frac{-z}{z-2} \quad |z| < 2$$

Hence

$$\begin{aligned}
 F[z] &= \frac{z}{z-0.8} - \frac{z}{z-2} \quad 0.8 < |z| < 2 \\
 &= \frac{-1.2z}{z^2 - 2.8z + 1.6} \quad 0.8 < |z| < 2
 \end{aligned}$$

(b)

$$F_1[z] = \frac{z}{z-2} \quad |z| > 2$$

$$F_2[z] = \frac{z}{z-3} \quad |z| < 3$$

Hence

$$\begin{aligned}
 F[z] &= \frac{z}{z-2} + \frac{z}{z-3} \quad 2 < |z| < 3 \\
 &= \frac{z(2z-5)}{z^2 - 5z + 6} \quad 2 < |z| < 3
 \end{aligned}$$

(c)

$$F_1[z] = \frac{z}{z-0.8} \quad |z| > 0.8$$

$$F_2[z] = \frac{-z}{z-0.9} \quad |z| < 0.9$$

$$\begin{aligned} \text{Hence } F[z] &= \frac{z}{z-0.8} - \frac{z}{z-0.9} \\ &= \frac{-z}{10(z^2 - 1.7z + 0.72)} \quad 0.8 < |z| < 0.9 \end{aligned}$$

(d)

$$\begin{aligned} [(0.8)^k + 3(0.4)^k] u[-(k+1)] &\iff \left( \frac{-z}{z-0.8} - \frac{3z}{z-0.4} \right) \quad |z| < 0.4 \\ &= \frac{-4z(z-0.7)}{(z-0.4)(z-0.8)} \quad |z| < 0.4 \end{aligned}$$

(e)

$$\begin{aligned} [(0.8)^k + 3(0.4)^k] u[k] &\iff \frac{z}{z-0.8} + \frac{3z}{z-0.4} \quad |z| > 0.8 \\ &= \frac{4z(z-0.7)}{(z-0.4)(z-0.8)} \quad |z| > 0.8 \end{aligned}$$

(f)

$$(0.8)^k u[k] + 3(0.4)^k u[-(k+1)]$$

The region of convergence for  $(0.8)^k u[k]$  is  $|z| > 0.8$ . The region of convergence for  $(0.4)^k u[-(k+1)]$  is  $|z| < 0.4$ . The common region does not exist. Hence the  $z$ -transform for this function does not exist.

11.7-2

$$\frac{F[z]}{z} = \frac{e^{-2} - 2}{(z - e^{-2})(z - 2)} = \frac{1}{z - e^{-2}} - \frac{1}{z - 2}$$

$$\text{and } F[z] = \frac{z}{z - e^{-2}} - \frac{z}{z - 2}$$

(a) The region of convergence is  $|z| > 2$ . Both terms are causal. And

$$f[k] = (e^{-2k} - 2^k)u[k]$$

(b) The region of convergence is  $e^{-2} < |z| < 2$ . In this case the 1st term is causal and the second is anticausal.

$$f[k] = e^{-2k}u[k] + 2^k u[-(k+1)]$$

(c) The region of convergence is  $|z| < e^{-2}$ . Both terms are anticausal in this case.

$$f[k] = (-e^{-2k} + 2^k)u[-(k+1)]$$

11.7-3 For causal signals, the region of convergence may be ignored. We shall consider it only for noncausal inputs

(a)

$$Y[z] = F[z]H[z] = \frac{z^2}{(z-e)(z+0.2)(z-0.8)}$$

Modified partial fraction expansion of  $Y[z]$  yields

$$Y[z] = 0.477 \frac{z}{z-e} - 0.068 \frac{z}{z+0.2} - 0.412 \frac{z}{z-0.8}$$

and

$$y[k] = [0.477e^k - 0.068(-0.2)^k - 0.412(0.8)^k] u[k]$$

(b)

$$F[z] = \frac{-z}{z-2} \quad |z| < 2$$

$$H[z] = \frac{z}{(z+0.2)(z-0.8)} \quad |z| > 0.8$$



$$Y[z] = \frac{-z^2}{(z+0.2)(z-0.8)(z-2)} \quad 0.8 < |z| < 2$$

and

$$\frac{Y[z]}{z} = \frac{-z}{(z+0.2)(z-0.8)(z-2)} = \frac{1/11}{z+0.2} + \frac{2/3}{z-0.8} - \frac{0.758}{z-2}$$

Therefore  $Y[z] = \frac{1}{11} \frac{z}{z+0.2} + \frac{2}{3} \frac{z}{z-0.8} - 0.758 \frac{z}{z-2} \quad 0.8 < |z| < 2$

and  $y[k] = \left[ \frac{1}{11}(-0.2)^k + \frac{2}{3}(0.8)^k \right] u[k] + 0.758(2)^k u[-(k+1)]$

(c) The input in this case is the sum of the inputs in parts a and b hence the response will be the sum of the responses in part a and b.

11.7-4

$$f[k] = \underbrace{2^k u[k]}_{f_1[k]} + \underbrace{u[-(k+1)]}_{f_2[k]}$$

$$F_1[z] = \frac{z}{z-2} \quad |z| > 2$$

$$F_2[z] = \frac{-z}{z-1} \quad |z| < 1$$

There is no region of convergence common to  $F_1[z]$  and  $F_2[z]$

$$H[z] = \frac{z}{(z+0.2)(z-0.8)}$$

The region of convergence of  $H[z]$  is  $|z| > 0.8$  (assuming a causal system). We should find the response to  $f_1[k]$  and  $f_2[k]$  separately.

$$Y_1[z] = \frac{z^2}{(z-2)(z+0.2)(z-0.8)} \quad |z| > 2$$

The modified partial fractions of  $Y[z]$  yield

$$Y_1[z] = -\frac{1}{11} \frac{z}{z+0.2} - \frac{2}{3} \frac{z}{z-0.8} + 0.758 \frac{z}{z-2}$$

and

$$y_1[k] = \left[ -\frac{1}{11}(-0.2)^k - \frac{2}{3}(0.8)^k + 0.758(2)^k \right] u[k]$$

Similarly

$$Y_2[z] = \frac{-25}{6} \frac{z}{z-1} + \frac{1}{6} \frac{z}{z+0.2} + 4 \frac{z}{z-0.8} \quad 0.8 < |z| < 1$$

and

$$y_2[k] = \left[ \frac{1}{6}(-0.2)^k + 4(0.8)^k \right] u[k] + \frac{25}{6} u[-(k+1)]$$

and

$$y[k] = y_1[k] + y_2[k] = \left[ \frac{5}{66}(-0.2)^k + \frac{10}{3}(0.8)^k + 0.758(2)^k \right] u[k] + \frac{25}{6} u[-(k+1)]$$

11.7-5

$$F[z] = \frac{-z}{z-e^2} \quad |z| < e^2$$

and

$$H[z] = \frac{z}{(z+0.2)(z-0.8)} \quad |z| > 0.8$$

No common region of convergence for  $F[z]$  and  $H[z]$  exists. Hence

$$y[k] = \infty$$

# Chapter 12

---

12.1-1 (a)

$$H[z] = \frac{1}{z - 0.4} \quad \text{and} \quad H[e^{j\Omega}] = \frac{1}{e^{j\Omega} - 0.4} = \frac{1}{\cos \Omega - 0.4 + j \sin \Omega}$$

$$|H[e^{j\Omega}]|^2 = HH^* = \frac{1}{(e^{j\Omega} - 0.4)(e^{-j\Omega} - 0.4)} = \frac{1}{1.16 - 0.8 \cos \Omega}$$

$$|H[e^{j\Omega}]| = \frac{1}{\sqrt{1.16 - 0.8 \cos \Omega}}$$

and

$$\angle H[e^{j\Omega}] = -\tan^{-1} \frac{\sin \Omega}{\cos \Omega - 0.4}$$

(b)

$$H[z] = \frac{z}{z - 0.4} = \frac{1}{1 - 0.4z^{-1}}$$

$$\text{and} \quad H[e^{j\Omega}] = \frac{1}{1 - 0.4e^{-j\Omega}} = \frac{1}{1 - 0.4 \cos \Omega - j \sin \Omega}$$

Therefore

$$|H[e^{j\Omega}]| = \sqrt{HH^*} = \sqrt{\frac{1}{1 - 0.4e^{-j\Omega}} \frac{1}{1 - 0.4e^{j\Omega}}} = \frac{1}{\sqrt{1.16 - 0.8 \cos \Omega}}$$

and

$$\angle H[e^{j\Omega}] = -\tan^{-1} \left( \frac{0.4 \sin \Omega}{1 - 0.4 \cos \Omega} \right)$$

(c)

$$H[z] = \frac{3z^2 - 1.8z}{z^2 - z + 0.16}$$

$$\text{and} \quad H[e^{j\Omega}] = \frac{3e^{2j\Omega} - 1.8e^{j\Omega}}{e^{2j\Omega} - e^{j\Omega} + 0.16} = \frac{(3 \cos 2\Omega - 1.8 \cos \Omega) + j(3 \sin 2\Omega - 1.8 \sin \Omega)}{(\cos 2\Omega - \cos \Omega + 0.16) + j(\sin 2\Omega - \sin \Omega)}$$

$$\begin{aligned} |H[e^{j\Omega}]|^2 &= \left[ \frac{3e^{2j\Omega} - 1.8e^{j\Omega}}{e^{2j\Omega} - e^{j\Omega} + 0.16} \right] \left[ \frac{3e^{-2j\Omega} - 1.8e^{-j\Omega}}{e^{-2j\Omega} - e^{-j\Omega} + 0.16} \right] \\ &= \frac{12.24 - 10.8 \cos \Omega}{2.0256 - 2.32 \cos \Omega + 0.32 \cos 2\Omega} \end{aligned}$$

$$\text{Therefore} \quad |H[e^{j\Omega}]| = \left[ \frac{12.24 - 10.8 \cos \Omega}{2.0256 - 2.32 \cos \Omega + 0.32 \cos 2\Omega} \right]^{1/2}$$

and

$$\angle H[e^{j\Omega}] = \tan^{-1} \left( \frac{3 \sin 2\Omega - 1.8 \sin \Omega}{3 \cos 2\Omega - 1.8 \cos \Omega} \right) - \tan^{-1} \left( \frac{\sin 2\Omega - \sin \Omega}{\cos 2\Omega - \cos \Omega + 0.16} \right)$$

12.1-2 (a)

$$H[z] = 1 + \frac{0.5}{z} + \frac{2}{z^2} + \frac{2}{z^3} + \frac{0.5}{z^4} + \frac{1}{z^5}$$

$$\begin{aligned}
H[e^{j\Omega}] &= 1 + 0.5e^{-j\Omega} + 2e^{-2j\Omega} + 2e^{-j3\Omega} + 0.5e^{-j4\Omega} + e^{-j5\Omega} \\
&= e^{-j2.5\Omega} [e^{j2.5\Omega} + 0.5e^{j1.5\Omega} + 2e^{j0.5\Omega} + 0.5e^{-j1.5\Omega} + e^{-j2.5\Omega}] \\
&= 2e^{-j2.5\Omega} \left[ 2\cos\frac{\Omega}{2} + \frac{1}{2}\cos\frac{3\Omega}{2} + \cos\frac{5\Omega}{2} \right]
\end{aligned}$$

Therefore  $|H[e^{j\Omega}]| = \left| 4\cos\frac{\Omega}{2} + \cos\frac{3\Omega}{2} + 2\cos\frac{5\Omega}{2} \right|$

and  $\angle H[e^{j\Omega}] = -2.5\Omega$

(b) Using the same procedure as in Prob. 5.45a, we obtain:

$$|H[e^{j\Omega}]| = \left| 4\sin\frac{\Omega}{2} + \sin\frac{3\Omega}{2} + 2\sin\frac{5\Omega}{2} \right|$$

and  $\angle H[e^{j\Omega}] = -2.5\Omega - \pi/2$ .

**12.1-3**

$$H[z] = \frac{z + 0.8}{z - 0.5}$$

(a)

$$\begin{aligned}
H[e^{j\Omega}] &= \frac{e^{j\Omega} + 0.8}{e^{j\Omega} - 0.5} = \frac{(\cos\Omega + 0.8) + j\sin\Omega}{(\cos\Omega - 0.5) + j\sin\Omega} \\
|H[e^{j\Omega}]|^2 &= H[e^{j\Omega}]H[e^{-j\Omega}] = \frac{(e^{j\Omega} + 0.8)(e^{-j\Omega} + 0.8)}{(e^{j\Omega} - 0.5)(e^{-j\Omega} - 0.5)} = \frac{1.64 + 1.6\cos\Omega}{1.25 - \cos\Omega} \\
\angle H[e^{j\Omega}] &= \tan^{-1}\left(\frac{\sin\Omega}{\cos\Omega + 0.8}\right) - \tan^{-1}\left(\frac{\sin\Omega}{\cos\Omega - 0.5}\right)
\end{aligned}$$

(b)  $\Omega = 0.5$

$$\begin{aligned}
|H[e^{j0.5}]|^2 &= \frac{1.64 + 1.6\cos(0.5)}{1.25 - \cos(0.5)} = 8.174 \\
|H[e^{j0.5}]| &= 2.86 \\
\angle H[e^{j0.5}] &= 0.2784 - 0.9037 = -0.6253 \text{ rad}
\end{aligned}$$

Therefore

$$y[k] = 2.86 \cos(0.5k - \frac{\pi}{3} - 0.6253) = 2.86 \cos(0.5k - 1.6725)$$

**12.1-4**

$$Y[z] = F[z]H[z]$$

For an input  $f[k] = e^{j\Omega k}u[k]$ , pair 7 in Table 11.1 yields

$$F[z] = \frac{z}{z - e^{j\Omega}}$$

and

$$Y[z] = \frac{zH[z]}{z - e^{j\Omega}}$$

Therefore if

$$H[z] = \frac{P[z]}{Q[z]} = \frac{P[z]}{(z - \gamma_1)(z - \gamma_2)\cdots(z - \gamma_n)}$$

then

$$Y[z] = \frac{zP[z]}{(z - \gamma_1)(z - \gamma_2)\cdots(z - \gamma_n)(z - e^{j\Omega})}$$

and

$$\begin{aligned} \frac{Y[z]}{z} &= \frac{P[z]}{(z - \gamma_1)(z - \gamma_2) \cdots (z - \gamma_n)(z - e^{j\Omega})} \\ &= \frac{c_1}{z - \gamma_1} + \frac{c_2}{z - \gamma_2} + \cdots + \frac{c_n}{z - \gamma_n} + \frac{A}{z - e^{j\Omega}} \end{aligned}$$

The coefficient  $A$  on the right-hand side is given by

$$\begin{aligned} A &= \left. \frac{P[z]}{(z - \gamma_1)(z - \gamma_2) \cdots (z - \gamma_n)(z - e^{j\Omega})} \right|_{z=e^{j\Omega}} \\ &= H[z] \Big|_{z=e^{j\Omega}} \\ &= H[e^{j\Omega}] \end{aligned}$$

Therefore

$$Y[z] = \sum_{i=1}^n c_i \frac{z}{z - \gamma_i} + H[e^{j\Omega}] \frac{z}{z - e^{j\Omega}}$$

and

$$y[k] = \left[ \sum_{i=1}^n c_i \gamma_i^k + H[e^{j\Omega}] e^{j\Omega k} \right] u[k]$$

The sum on the right-hand side consists of  $n$  characteristic modes the system. For an asymptotically stable system  $|\gamma_i| < 1$  ( $i = 1, 2, \dots, n$ ) and the sum on the right-hand side vanishes as  $k \rightarrow \infty$ . This sum is therefore the **transient** component of the response. The last terms  $H[e^{j\Omega}] e^{j\Omega k}$ , which does not vanish as  $k \rightarrow \infty$ , is the **steady-state** component of the response  $y_{ss}[k]$ :

$$y_{ss}[k] = H[e^{j\Omega}] e^{j\Omega k}$$

12.1-5 (a)  $\mathcal{F}_h = \frac{1}{2T} = \frac{10^6}{50 \times 2} = 10$  kHz.

(b)  $\mathcal{F}_s \geq 2\mathcal{F}_h = 100$  kHz,  $T \leq \frac{1}{\mathcal{F}_s} = 10$   $\mu$ s.

12.2-1 Figure S12.2-1 shows a rough sketch of the amplitude and phase response of this filter. For the case (a), the poles are in the vicinity of  $\Omega = \frac{\pi}{4}$ . Therefore, the gain  $|H[e^{j\Omega}]|$  is high in the vicinity of  $\Omega = \frac{\pi}{4}$ . In the case (b), the poles are in the vicinity of  $\Omega = \pi$ . therefore, the gain  $|H[e^{j\Omega}]|$  is high in the vicinity of  $\Omega = \pi$ . For case (a), the phases of the two poles are equal and opposite at  $\Omega = 0$ . Hence  $\angle H[e^{j\Omega}]$  starts at 0 (for  $\Omega = 0$ ). As  $\Omega$  increases, the angle due to both poles increase. Hence,  $\angle H[e^{j\Omega}]$  increases in negative direction until it reaches the value  $-2\pi$  at  $\Omega = \pi$ . For case (b), similar behavior is observed. Note that angle  $-2\pi$  is the same as 0.

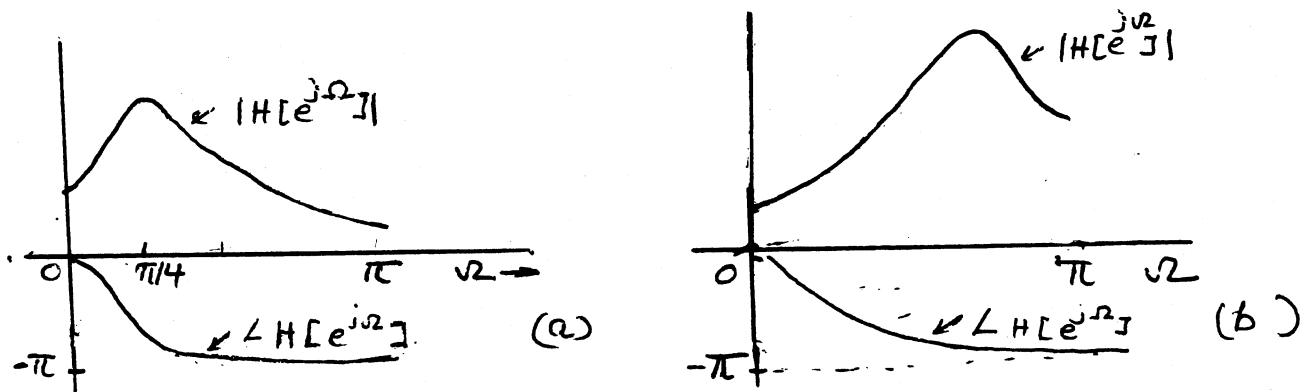

Fig. S12.2-1

12.2-2

$$H[z] = K \frac{z+1}{z-a}$$

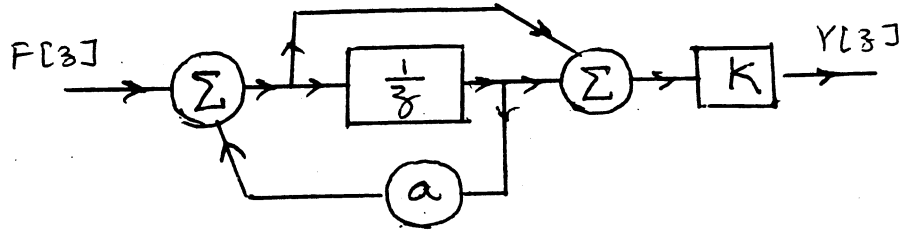

Figure S12.2-2

Figure S12.2-2a shows the realization. Fig. b shows the pole-zero configuration, and Fig. c shows the amplitude response of the filter. Observe that the pole at  $a$  is close to  $\Omega = 0$ . Hence, there is the highest gain at dc. There is a zero at  $-1$ , which represents  $\Omega = \pi$ . Hence, the gain is zero at  $\Omega = \pi$ . This is a lowpass filter.

$$H[e^{j\Omega}] = K \left( \frac{e^{j\Omega} + 1}{e^{j\Omega} - a} \right) = K \left( \frac{\cos \Omega + 1 + j \sin \Omega}{\cos \Omega - a + j \sin \Omega} \right)$$

$$|H[e^{j\Omega}]| = K \sqrt{\frac{2(1 + \cos \Omega)}{1 + a^2 - 2a \cos \Omega}}$$

For  $a = 0.2$

$$|H[e^{j\Omega}]| = K \sqrt{\frac{2(1 + \cos \Omega)}{1.04 - 0.4 \cos \Omega}}$$

The dc gain is

$$|H[e^{j0}]| = 2.5K$$

For 3 dB bandwidth  $|H[e^{j\Omega}]|^2 = \frac{1}{2}|H[e^{j0}]|^2 = 3.125K^2$ . Hence

$$3.125K^2 = K^2 \left[ \frac{2(1 + \cos \Omega)}{1.04 - 0.4 \cos \Omega} \right] \Rightarrow \Omega = 1.176$$

$$\text{Hence } B = \frac{\omega}{2\pi} = \frac{1.176}{2\pi T} = \frac{0.187}{T} \text{ Hz}$$

### 12.2-3

$$T \leq \frac{1}{2B_h} = \frac{1}{40000} = 25 \mu\text{s}$$

Select  $T = 25 \mu\text{s}$

Frequency 5000 Hz gives

$$\Omega = \omega T = 2\pi \times 5000 \times 25 \times 10^{-6} = \pi/4$$

Therefore frequency 5000 Hz corresponds to angles  $\pm\pi/4$ . We must place zeros at  $e^{\pm j\pi/4}$ . For fast recovery on either side of 5000 Hz, we read poles at  $ae^{\pm j\pi/4}$  where  $a < 1$  and  $a \simeq 1$ .

The transfer function is

$$\begin{aligned} H[z] &= K \frac{(z - e^{j\pi/4})(z - e^{-j\pi/4})}{(z - ae^{j\pi/4})(z - ae^{-j\pi/4})} \\ &= \frac{K(z^2 - \sqrt{2}z + 1)}{z^2 - \sqrt{2}az + a^2} \end{aligned}$$

The constant  $K$  is chosen to have unity gain at  $\omega = 0$  ( $\Omega = 0$ ) or  $z = e^{j\Omega} = 1$ . ( $H[1] = 1$ )

$$H[1] = \frac{K(2 - \sqrt{2})}{1 + a^2 - \sqrt{2}a} = 1$$

$$K = \frac{1 + a^2 - \sqrt{2}a}{2 - \sqrt{2}} = 1.707(1 + a^2 - \sqrt{2}a)$$

$$\begin{aligned} |H[e^{j\Omega}]|^2 &= K^2 \frac{(e^{j2\Omega} - \sqrt{2}e^{j\Omega} + 1)(e^{-j2\Omega} - \sqrt{2}e^{-j\Omega} + 1)}{(e^{j2\Omega} - \sqrt{2}ae^{j\Omega} + a^2)(e^{-j2\Omega} - \sqrt{2}ae^{-j\Omega} + a^2)} \\ &= K^2 \frac{4 - 4\sqrt{2}\cos \Omega + 2\cos 2\Omega}{(1 + a^2)^2 - 2\sqrt{2}a(1 + a^2)\cos \Omega + 2a^2\cos 2\Omega} \end{aligned}$$

$$|H[e^{j\Omega}]|^2 = H[e^{j\Omega}] H[e^{-j\Omega}] = \frac{(e^{j\Omega} - \frac{1}{r})(e^{-j\Omega} - \frac{1}{r})}{(e^{j\Omega} - r)(e^{-j\Omega} - r)} = \frac{1 + \frac{1}{r^2} - \frac{2}{r} \cos \Omega}{1 + r^2 - 2r \cos \Omega} = \frac{1}{r^2}$$

This shows that the amplitude response is constant ( $|H[e^{j\Omega}]| = \frac{1}{r}$ ) for all values of  $\Omega$ . The filter is an allpass filter. This result can be generalized exactly the same way for complex poles and zeros.

- 12.4-1** The frequency response of a digital filter is  $H[e^{j\omega T}]$ . Changing the sampling interval from  $T$  to  $aT$  will change the frequency response to  $H[e^{j\omega aT}]$ . This is a frequency-scaled version of the original transfer function  $H[e^{j\omega T}]$ . Thus, changing the sampling interval  $T$  to  $aT$  compresses the frequency response by the factor  $a$ . Thus, changing  $T$  from  $50 \mu\text{s}$  to  $25 \mu\text{s}$  will change the cutoff frequency of the filter from 10 kHz to 20 kHz. Similarly, changing  $T$  from  $50 \mu\text{s}$  to  $100 \mu\text{s}$  will change the cutoff frequency of the filter from 10 kHz to 5 kHz.

- 12.5-1 (a)**

$$H_a(s) = \frac{7s + 20}{2(s^2 + 7s + 10)} = \frac{7s + 20}{2(s+2)(s+5)} = \frac{1}{s+2} + \frac{5/2}{s+5}$$

Using Table 12.1, we get

$$H[z] = T \left[ \frac{z}{z - e^{-2T}} + \frac{5}{2} \frac{z}{z - e^{-5T}} \right]$$

First we select  $T$ :

$$H_a(0) = 1 \quad \text{and for } s \gg 5 \implies H_a(s) \approx \frac{7}{2s}$$

$$\text{and } |H_a(j\omega)| \simeq \frac{7}{\omega} \quad \omega \gg 5$$

We shall choose the filter bandwidth to be that frequency where

$$|H_a(j\omega_0)| \text{ is 1\% of } |H_a(0)|. \quad \text{Hence } \frac{7}{2\omega_0} = 0.01 \quad \text{and } \omega_0 = 350, \quad T = \frac{\pi}{350}$$

Substituting this value of  $T$  in  $H[z]$  yields

$$H[z] = 0.008976 \left[ \frac{z}{z - 0.9822} + \frac{5}{2} \frac{z}{z - 0.9561} \right] = 0.031416z \left[ \frac{z - 0.97474}{z^2 - 1.9383z + 0.9391} \right]$$

- 1) Canonical realization:

$$H[z] = \frac{0.031416z^2 - 0.03062z}{z^2 - 1.9383z + 0.9391}$$

- 2) parallel realization:

$$H[z] = \frac{0.008976z}{z - 0.9822} + \frac{0.02244z}{z - 0.9561}$$

The canonical and the parallel realizations are shown in Fig. S12.5-1.

- 12.5-2**  $H_a(s) = \frac{1}{s^2 + \sqrt{2}s + 1}$ . Using Table 12.1, we get

$$H[z] = \left[ \frac{\sqrt{2}Tze^{-T/\sqrt{2}} \sin\left(\frac{T}{\sqrt{2}}\right)}{z^2 - 2ze^{-T/\sqrt{2}} \cos\left(\frac{T}{\sqrt{2}}\right) + e^{-\sqrt{2}T}} \right]$$

We now select  $T$ :

$$H_a(0) = 1 \quad \text{and for high } s, H_a(s) \approx \frac{1}{s^2}$$

$$\text{and } |H_a(j\omega)| \simeq \frac{1}{\omega^2} \quad \text{for high } \omega$$

For negligible aliasing, we select the frequency  $\omega_0$  to be that where

$$|H_a(j\omega_0)| \text{ is 1\% of } |H_a(0)|. \quad \text{Hence } \frac{1}{\omega_0^2} = 0.01. \quad \text{and } \omega_0 = 10$$

$$\text{and } T = \frac{\pi}{\omega_0} = \pi/10$$

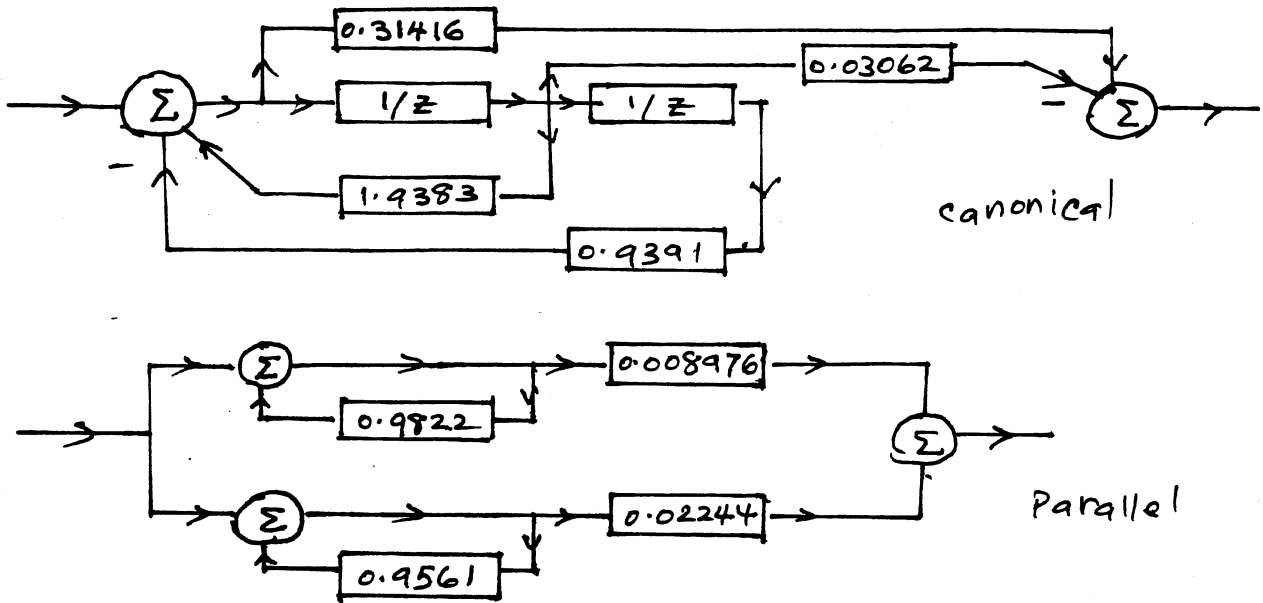

Figure S12.5-1

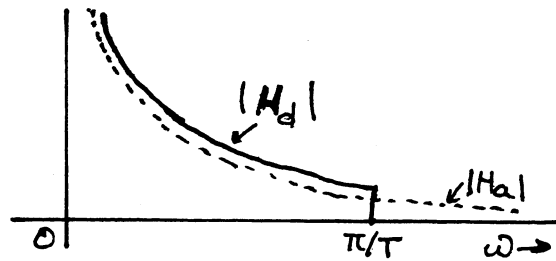

Figure S12.5-3

Substitution of this value of  $T$  in  $H[z]$  yields

$$H[z] = \frac{0.0784z}{z^2 - 1.5622z + 0.6413}$$

**12.5-3** For an ideal integrator

$$H_a(s) = \frac{1}{s}$$

From Table 12.1, we find

$$H[z] = \frac{Tz}{z-1} \quad \text{and} \quad H[e^{j\omega T}] = \frac{T e^{j\omega T}}{e^{j\omega T} - 1}$$

Therefore,

$$\begin{aligned} |H[e^{j\omega T}]| &= \frac{T}{\sqrt{(\cos \omega T - 1)^2 + \sin^2 \omega T}} \\ &= \frac{T}{|\sqrt{2(1 - \cos \omega T)}|} \\ &= \frac{T}{2|\sin \frac{\omega T}{2}|} \quad |\omega| \leq \frac{\pi}{T} \end{aligned}$$

The ideal integrator amplitude response is

$$|H_a(j\omega)| = \frac{1}{\omega}$$

The two response characteristics are shown in Fig. S12.5-3.

**12.5-4 (a)** Because an oscillator output is basically a system output with no input, a system with zero-input response of the form  $\sin \Omega_0 k$  (or  $\cos(\Omega_0 k + \theta)$  with any value of  $\theta$ ), where  $\Omega_0 = \omega_0 T$  will serve as the desired oscillator. A marginally stable system with impulse response of the above form is a candidate. From Table 12.1, pair 11b, we see that a transfer function

$$H[z] = \frac{z \sin \omega_0 T}{z^2 - 2z \cos \omega_0 T + 1}$$

has an impulse response (or zero-input response) of the form  $\sin \Omega_0 k$  ( $\Omega_0 = \omega_0 T$ ). The period of the sinusoid is  $T_0 = 2\pi/\Omega_0$ , and there are 10 samples in each cycle. Therefore, the sampling interval  $T = T_0/10 = \pi/5\Omega_0$ , and  $\Omega_0 T = \pi/5$ , hence,

$$\begin{aligned} H[z] &= \frac{z \sin\left(\frac{\pi}{5}\right)}{z^2 - 2 \cos\left(\frac{\pi}{5}\right) z + 1} \\ &= \frac{0.5878z}{z^2 - 1.618z + 1} \end{aligned}$$

This is one possible solution. By varying the phase in the impulse response, we could obtain variations of this transfer function.

**(b)** Another approach is to consider an analog system with transfer function  $H_a(s)$  such that its impulse response (or zero-input response) is of the form  $\sin \omega_0 t$  (or  $\cos(\omega_0 t + \theta)$  for any value of  $\theta$ ). From Table 6.1, pair 8b we find

$$H_a(s) = \frac{\omega_0}{s^2 + \omega_0^2}$$

Now using Table 12.1, we find the corresponding digital filter using impulse invariance method as

$$H[z] = \frac{Tz \sin \omega_0 T}{z^2 - 2z \cos \omega_0 T + 1}$$

Earlier we found that  $\omega_0 T = \pi/5$ . Because  $\omega_0 = 2\pi(10,000) = 20,000\pi$ , the period  $T_0 = 10^{-4}$ . There are 10 samples in each period. Hence the sampling interval  $T = 10^{-5}$ , and

$$H[z] = 10^{-5} \frac{0.5878z}{z^2 - 1.618z + 1}$$

This is identical to the answer in **(a)** except for an amplitude scaling by  $10^{-5}$ . Because, we did not specify any amplitude requirement on the oscillator, different answers will differ by a constant multiplier. This is a marginally stable system and will oscillate without input with the response of the form

$$h[k] = 10^{-5} \sin(0.2\pi k)$$

This is a discrete sinusoid with 10 samples 1 cycle each. Sample is separated by  $10^{-5}$  second. Hence the duration (period) of a cycle is  $10 \times 10^{-5} = 10^{-4}$  and the frequency of oscillator is  $10^4$  Hz or 10 kHz as desired. The controller canonical form of realization is shown in Fig. S12.5-4. Note that the multiplier  $10^{-5}$  is not important in this realization, and hence is not shown in the figure. Also, there is no input to an oscillator. Hence no explicit input terminal is shown.

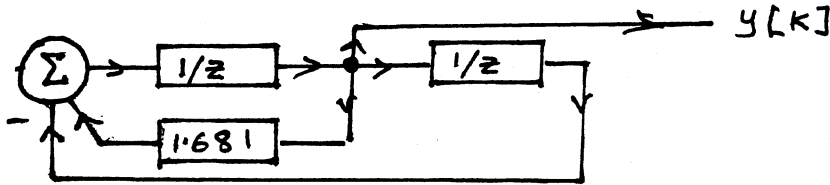

Figure S12.5-4

**12.5-5 (a)** If  $g_a(t)$  is the unit step response of the system  $H_a(s)$  in Fig. 12.8b. Then  $g_a(kT)$  should be the response of  $H[z]$  to the input  $u[k]$ . We can use this criterion to design a digital filter to realize a given  $H_a(s)$ . Consider the filter

$$H_a(s) = \frac{\omega_c}{s + \omega_c}$$

The unit step response  $g_a(t)$  is given by:



$$g_a(t) = \mathcal{L}^{-1} \left[ \frac{H_a(s)}{s} \right] = \mathcal{L}^{-1} \left[ \frac{\omega_c}{s(s + \omega_c)} \right] = \mathcal{L}^{-1} \left[ \frac{1}{s} - \frac{1}{s + \omega_c} \right]$$

$$\text{Therefore } g_a(t) = (1 - e^{-\omega_c t})u(t)$$

$$\text{and } g_a(kT) = (1 - e^{-\omega_c kT})u[k]$$

Also,  $g[k]$ , the response of  $H[z]$  to  $u[k]$  is given by:

$$g[k] = \mathcal{Z}^{-1} \left\{ \frac{z}{z-1} H[z] \right\}$$

Since  $g[k] = g_a(kT)$ ,

$$\begin{aligned} \frac{z}{z-1} H[z] &= \mathcal{Z} \{ (1 - e^{-\omega_c kT})u[k] \} \\ &= \frac{z}{z-1} - \frac{z}{z - e^{-\omega_c T}} = \frac{z(1 - e^{-\omega_c T})}{(z-1)(z - e^{-\omega_c T})} \end{aligned}$$

$$\text{Therefore } H[z] = \frac{1 - e^{-\omega_c T}}{z - e^{-\omega_c T}}$$

Using the above argument, we can generalize:

$$H[z] = \frac{z-1}{z} \mathcal{Z} \left[ \mathcal{L}^{-1} \left( \frac{H_a(s)}{s} \right) \right]_{t=kT}$$

(b)

$$\text{For } H_a(s) = \frac{\omega_c}{s + \omega_c}$$

the unit step invariance method gives

$$H[z] = \frac{1 - e^{-\omega_c T}}{z - e^{-\omega_c T}}$$

(c) For an integrator,  $H_a(s) = 1/s$ , and  $\mathcal{L}^{-1}\{H_a(s)/s\} = tu(t)$ , and

$$H[z] = \frac{z-1}{z} \mathcal{Z}[kT u[k]] = \frac{T}{z-1}$$

and

$$H[e^{j\omega T}] = \frac{T}{e^{j\omega T} - 1}$$

Hence,

$$|H[e^{j\omega T}]| = \frac{T}{|\sqrt{(\cos \omega T - 1)^2 + \sin^2 \omega T}|} = \frac{T}{|\sqrt{2(1 - \cos \omega T)}|} = \frac{T}{2|\sin \frac{\omega T}{2}|} \quad |\omega| \leq \frac{\pi}{T}$$

The ideal integrator amplitude response is

$$|H_a(j\omega)| = \frac{1}{\omega}$$

Observe that this amplitude response is identical to that found by the impulse invariance method in Prob. 12.5-3. Hence, this amplitude response and the ideal integrator amplitude response are the same as those in Fig. S12.5-3. The only difference between the answers obtained by these methods is that the phase response of the step invariance response differs from that of the impulse invariance method by a constant  $\frac{\pi}{2}$ .

#### 12.5-6 (a) For a differentiator

$$H_a(s) = s$$

The unit ramp response  $r(t)$  is given by

$$r(t) = \mathcal{L}^{-1} F(s) H_a(s) = \mathcal{L}^{-1} \frac{1}{s^2}(s) = u(t)$$

Now we must design  $H[z]$  such that its response to input  $kTu[k]$  is  $u[k]$ , that is

$$\mathcal{Z}\{u[k]\} = H[z]\mathcal{Z}\{kTu[k]\}$$

$$\frac{z}{z-1} = \frac{Tz}{(z-1)^2}H[z] \quad \text{or} \quad H[z] = \frac{1}{T}(z-1)$$

(b) For an integrator

$$H(s) = \frac{1}{s}$$

The unit ramp response  $r(t)$  is given by

$$r(t) = \mathcal{L}^{-1}\left(\frac{1}{s^2}\right)\frac{1}{s} = \frac{1}{2}t^2u(t)$$

Now we design  $H[z]$  such that its response to  $kTu[k]$  is  $\frac{1}{2}k^2T^2u[k]$ , that is

$$\mathcal{Z}\left\{\frac{1}{2}k^2T^2u[k]\right\} = H[z]\mathcal{Z}\{kTu[k]\}$$

or

$$\frac{T^2z(z+1)}{2(z-1)^3} = \frac{Tz}{(z-1)^2}H[z]$$

Hence

$$H[z] = \frac{T}{2}\left(\frac{z+1}{z-1}\right)$$

#### 12.5-7

$$\text{For } H_a(s) = \sum_i \frac{k_i}{s - \lambda_i}, \quad H[z] = T \sum_i \frac{k_i z}{z - e^{\lambda_i T}}$$

If  $\lambda_i = \alpha_i + j\beta_i$ , then  $e^{\lambda_i T} = e^{\alpha_i T} e^{j\beta_i T}$ . When  $\lambda_i$  is in LHP,  $\alpha_i < 0$  and  $|e^{\lambda_i T}| = e^{\alpha_i T} < 1$ . Hence if  $\lambda_i$  is in LHP, the corresponding pole of  $H[z]$  is within the unit circle. Clearly if  $H_a(s)$  is stable, the corresponding  $H[z]$  is also stable.

**12.6-1 (a)** For an ideal differentiator  $H_a(s) = s$ , and the bilinear transformation is  $s \rightarrow \frac{2}{T} \frac{z-1}{z+1}$ . Therefore,

$$\text{and } H[z] = \frac{2}{T} \frac{z-1}{z+1}$$

(b) Realization of this filter is shown in Fig. S12.6-1a. The amplitude response of this filter is given by

$$\begin{aligned} \text{and } |H[e^{j\omega T}]| &= \frac{2}{T} \left| \frac{e^{-j\omega T} - 1}{e^{j\omega T} + 1} \right| \\ &= \frac{2}{T} \left| \sqrt{\frac{2(1 - \cos \omega T)}{2(1 + \cos \omega T)}} \right| \\ &= \frac{2}{T} \left| \tan \frac{\omega T}{2} \right| \end{aligned}$$

(c) For ideal differentiator,  $H(s) = s$ , and  $|H(j\omega)| = \omega$ . Figure S12.6-1b shows the amplitude response of the ideal and the bilinear differentiators.

(d) For audio signals the highest significant frequency is 20 kHz. Hence

$$T = \frac{1}{f_s} = \frac{1}{2(20000)} = 25 \mu\text{s}$$

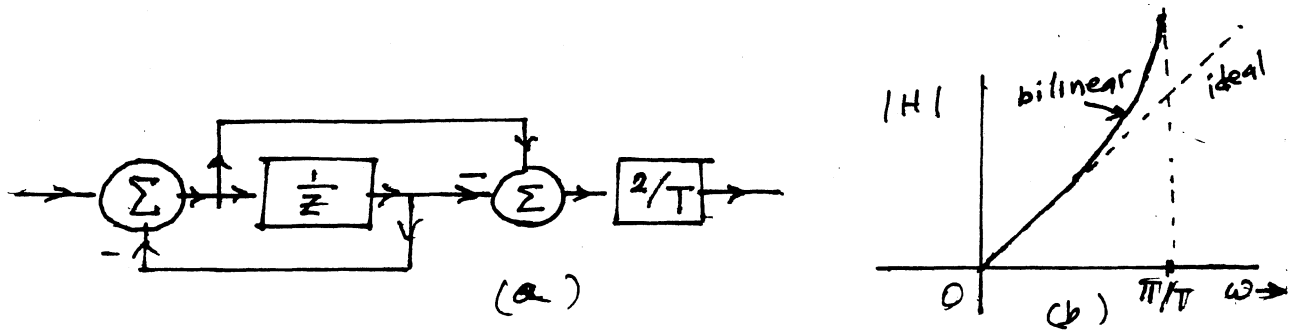

Figure S12.6-1

12.6-2 (a) For an ideal integrator,  $H(s) = 1/s$ , and the use bilinear transformation yields

$$H[z] = \frac{Tz + 1}{2z - 1}$$

$$\begin{aligned} \text{and } |H[e^{j\omega T}]| &= \frac{T}{2} \left| \frac{e^{j\omega T} + 1}{e^{-j\omega T} - 1} \right| \\ &= \frac{T}{2} \left| \sqrt{\frac{1 + \cos \omega T}{1 - \cos \omega T}} \right| = \frac{T}{2} \left| \cot \frac{\omega T}{2} \right| \end{aligned}$$

For an ideal integrator,  $H(s) = 1/s$  and  $|H(j\omega)| = 1/\omega$ . Figure S12.6-2 shows the amplitude response of the ideal and the bilinear integrators.

(d) For audio signals the highest significant frequency is 20 kHz. Hence

$$T = \frac{1}{f_s} = \frac{1}{2(20000)} = 25\mu s$$

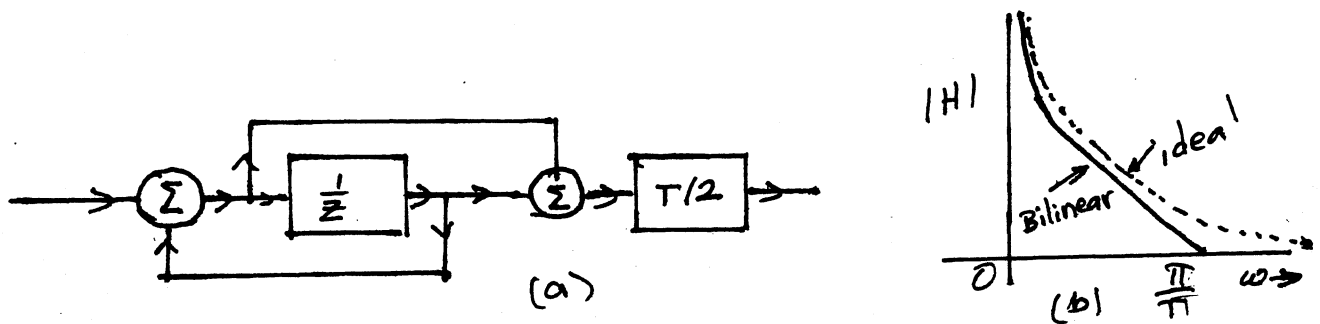

Figure S12.6-2

12.6-3 In this case,  $\hat{G}_p = -2$ ,  $\hat{G}_s = -11$ ,  $\omega_p = 100\pi$ ,  $\omega_s = 200\pi$  and  $T = 1/500$ . Using Eq. (12.64a), we compute the prewarped frequencies as  $\omega_p' = 0.3249$ ,  $\omega_s' = 0.7265$ . Using Eq. (7.39), we obtain  $n = 1.8556$ , which is rounded up to  $n = 2$ . To oversatisfy  $\hat{G}_s$  requirement (or to satisfy passband specs exactly), we use Eq. (7.40) to obtain  $\omega_c' = 0.3938$ . Using Table 7.1, we obtain the normalized transfer function, then substitute  $s/\omega_c'$  for  $s$  to obtain the desired analog transfer function as

$$H_a(s) = \frac{1}{\left(\frac{s}{0.3938}\right)^2 + \sqrt{2}\left(\frac{s}{0.3938}\right) + 1} = \frac{0.1551}{s^2 + 0.5569s + 0.1551}$$

Now using the bilinear transformation yields the desired digital transfer function as

$$H[z] = H_a(s) \Big|_{\frac{z-1}{z+1}} = \frac{0.09057(z+1)^2}{z^2 - 0.9871z + 0.3493}$$

**12.6-4** In this case,  $\hat{r} = 2$ ,  $\hat{G}_s = -11$ ,  $\omega_p = 100\pi$ ,  $\omega_s = 200\pi$  and  $T = 1/500$ . Using Eq. (12.64a), we compute the prewarped frequencies as  $\omega_p' = 0.3249$ ,  $\omega_s' = 0.7265$ . Using Eq. (7.49b), we obtain  $n = 1.5056$ , which is rounded up to  $n = 2$ . For  $n = 2$  and  $\hat{r} = 2$ , we obtain from Table 7.4

$$\mathcal{H}(s) = \frac{K_n}{s^2 + 0.8038s + 0.8231}$$

where, from Eq. (7.53)

$$K_n = \frac{a_0}{\sqrt{10^{\hat{r}/20}}} = \frac{0.8230}{1.2589} = 0.6537$$

We now substitute  $s/\omega_p'$  for  $s$  to obtain the desired analog transfer function as

$$H_a(s) = \frac{K_n}{\left(\frac{s}{0.3249}\right)^2 + 0.8038\left(\frac{s}{0.3249}\right) + 0.8230} = \frac{0.069}{s^2 + 0.2612s + 0.0869}$$

Now using the bilinear transformation yields the desired digital transfer function as

$$H[z] = H_a(s)\Big|_{\frac{z-1}{z+1}} = \frac{0.0512(z+1)^2}{z^2 - 1.355z + 0.6125}$$

**12.6-5** In this case,  $\hat{G}_p = -2$ ,  $\hat{G}_s = -10$ ,  $\omega_p = 150\pi$ ,  $\omega_s = 100\pi$  and  $T = 1/400$ . Using Eq. (12.64a), we compute the prewarped frequencies as  $\omega_p' = 0.6682$ ,  $\omega_s' = 0.4142$ . Using Eq. (7.39), we obtain  $n = 2.8584$ , which is rounded up to  $n = 3$ . We use Eq. (7.40) to obtain  $\omega_c' = 1.1185$ . Using Table 7.1, we obtain the normalized transfer function, then substitute  $s/\omega_c'$  for  $s$  to obtain the desired analog transfer function as

$$H_a(s) = \frac{1}{\left(\frac{s}{1.1185}\right)^3 + 2\left(\frac{s}{1.1185}\right)^2 + 2\left(\frac{s}{1.1185}\right) + 1} = \frac{1.3993}{s^3 + 2.2369s^2 + 2.5019s + 1.3991}$$

Now use of the transformation in Eq. (12.66) yields the desired digital transfer function as

$$H[z] = H_a(s)\Big|_{\frac{0.6682(z+1)}{z-1}} = \frac{0.3203(z-1)^3}{z^3 - 0.9102z^2 + 0.5545z + 0.0979}$$

**12.6-6** In this case,  $\hat{r} = 2$ ,  $\hat{G}_s = -10$ ,  $\omega_s = 100\pi$ ,  $\omega_p = 150\pi$  and  $T = 1/400$ . Using Eq. (12.64a), we compute the prewarped frequencies as  $\omega_s' = 0.4142$ ,  $\omega_p' = 0.6682$ . Using Eq. (7.49b), we obtain  $n = 1.9323$ , which is rounded up to  $n = 2$ . For  $n = 2$  and  $\hat{r} = 2$ , we obtain from Table 7.4

$$\mathcal{H}(s) = \frac{K_n}{s^2 + 0.8038s + 0.8231}$$

where, from Eq. (7.53)

$$K_n = \frac{a_0}{\sqrt{10^{\hat{r}/20}}} = \frac{0.8230}{1.2589} = 0.6537$$

We now substitute  $\omega_p'/s$  for  $s$  to obtain the desired analog transfer function as

$$H_a(s) = \frac{0.6537}{\left(\frac{0.6682}{s}\right)^2 + 0.8038\left(\frac{0.6682}{s}\right) + 0.8230} = \frac{0.7943s^2}{s^2 + 0.6526s + 0.5424}$$

Now using the bilinear transformation yields the desired digital transfer function as

$$H[z] = H_a(s)\Big|_{\frac{z-1}{z+1}} = \frac{0.3619(z-1)^2}{z^2 - 0.4169z + 0.4054}$$

**12.6-7** In this case,  $\hat{G}_p = -2$ ,  $\hat{G}_s = -12$ ,  $\omega_{p1} = 120$ ,  $\omega_{p2} = 300$ ,  $\omega_{s1} = 45$ ,  $\omega_{s2} = 450$  and  $T = 1/1000$ . Using Eq. (12.64a), we compute the prewarped frequencies as  $\omega_{p1}' = 0.0601$ ,  $\omega_{p2}' = 0.1511$ ,  $\omega_{s1}' = 0.0225$  and  $\omega_{s2}' = 0.2289$ . Using Eq. (7.39), we obtain  $n = 2.2113$ , which is rounded up to  $n = 3$ . We now compute the lowpass prototype transfer function for  $\hat{G}_p = -2$ ,  $\hat{G}_s = -12$ ,  $n = 2$ ,  $\omega_p = 1$ . We use Eq. (7.56) to compute  $\omega_s = 2.0778$ . Now use of Eq. (7.41) yields  $\omega_c' = 1.3253$ . Using Table 7.1, we obtain the normalized transfer function, then substitute  $s/\omega_c'$  for  $s$  to obtain the prototype analog transfer function as

$$\mathcal{H}_p(s) = \frac{1}{\left(\frac{s}{1.3253}\right)^3 + 2\left(\frac{s}{1.3253}\right)^2 + 2\left(\frac{s}{1.3253}\right) + 1} = \frac{2.3278}{s^3 + 2.6506s^2 + 3.5128s + 2.3278}$$

To use the transformation in Eq. (12.67a), we use Eq. (12.68) to compute

$$a = -0.9820, \quad b = 0.0902, \quad T_{bp}[z] = \frac{11.086(z^2 - 1.964z + 1)}{z^2 - 1}$$

To obtain the desired digital transfer function, we use the transformation

$$H[z] = \mathcal{H}_p(s) \Big|_{s=\frac{11.086(z^2-1.964z+1)}{z^2-1}} = \frac{0.001348(z^2-1)^3}{z^6 - 5.426z^5 + 12.37z^4 - 15.16z^3 + 10.54z^2 - 3.945z + 0.6205}$$

**12.6-8** In this case,  $\hat{r} = 2$ ,  $\hat{G}_s = -12$ ,  $\omega_{p1} = 120$ ,  $\omega_{p2} = 300$ ,  $\omega_{s1} = 45$ ,  $\omega_{s2} = 450$  and  $T = 1/1000$ . Using Eq. (12.64a), we compute the prewarped frequencies as  $\omega_{p1}' = 0.0601$ ,  $\omega_{p2}' = 0.1511$ ,  $\omega_{s1}' = 0.0225$  and  $\omega_{s2}' = 0.2289$ . We also find  $\omega_s = 2.0778$  from Eq. (7.56). Using Eq. (7.49a), we obtain  $n = 1.6905$ , which is rounded up to  $n = 2$ . We now compute the lowpass prototype transfer function for  $\hat{r} = 2$ ,  $\hat{G}_s = -12$ ,  $n = 2$ ,  $\omega_p = 1$ . Using Table 7.4, we obtain the normalized analog transfer function as

$$\mathcal{H}(s) = \frac{0.6538}{s^2 + 0.8038s + 0.8231}$$

Note that  $\mathcal{H}(s)$  is also the prototype transfer function  $\mathcal{H}_p(s)$  because in the Chebyshev filters,  $\omega_p = 1$ . To use the transformation in Eq. (12.67a), we use Eq. (12.68) to compute

$$a = -0.9820, \quad b = 0.0902, \quad T_{bp}[z] = \frac{11.086(z^2 - 1.964z + 1)}{z^2 - 1}$$

To obtain the desired digital transfer function, we use the transformation

$$H[z] = \mathcal{H}_p(s) \Big|_{s=\frac{11.086(z^2-1.964z+1)}{z^2-1}} = \frac{0.004933(z^2-1)^2}{z^4 - 3.772z^3 + 5.415z^2 - 3.508z + 0.8656}$$

**12.6-9** In this case,  $\hat{r} = 1$ ,  $\hat{G}_s = -22$ ,  $\omega_{p1} = 40$ ,  $\omega_{p2} = 195$ ,  $\omega_{s1} = 80$ ,  $\omega_{s2} = 120$  and  $T = 1/400$ . Using Eq. (12.64a), we compute the prewarped frequencies as  $\omega_{p1}' = 0.05$ ,  $\omega_{p2}' = 0.2487$ ,  $\omega_{s1}' = 0.1003$  and  $\omega_{s2}' = 0.1511$ . We also find  $\omega_s = 2.8878$  from Eq. (7.56). Using Eq. (7.49a), we obtain  $n = 2.2634$ , which is rounded up to  $n = 3$ . We now compute the lowpass prototype transfer function for  $\hat{r} = 1$ ,  $\hat{G}_s = -22$ ,  $n = 3$ ,  $\omega_p = 1$ . Using Table 7.4, we obtain the normalized analog transfer function as

$$\mathcal{H}(s) = \frac{0.4913}{s^3 + 0.9883s^2 + 1.238s + 0.4913}$$

Note that  $\mathcal{H}(s)$  is also the prototype transfer function  $\mathcal{H}_p(s)$  because in the Chebyshev filters,  $\omega_p = 1$ . To use the transformation in Eq. (12.67a), we use Eq. (12.68) to compute

$$a = -0.9754, \quad b = 0.1962, \quad T_{bp}[z] = \frac{0.1962(z^2 - 1)}{z^2 - 0.9754z + 1}$$

To obtain the desired digital transfer function, we use the transformation

$$H[z] = \mathcal{H}_p(s) \Big|_{s=\frac{0.1962(z^2-1)}{z^2-0.9754z+1}} = \frac{0.63(z^6 - 5.852z^5 + 14.416z^4 - 19.127z^3 + 14.416z^2 - 5.852z + 1)}{z^6 - 4.998z^5 + 10.5z^4 - 11.86z^3 + 7.565z^2 - 2.566z + 0.3575}$$

**12.6-10**

$$\text{Because } s = K \frac{z-1}{z+1} \quad \implies \quad z = \frac{K+s}{K-s}$$

where  $s = \sigma + j\omega$ . Hence

$$z = \frac{K + \sigma + j\omega}{K - \sigma - j\omega} \quad \text{and} \quad |z| = \sqrt{\frac{(K + \sigma)^2 + \omega^2}{(K - \sigma)^2 + \omega^2}}$$

It is clear that: if  $\sigma < 0 \implies |z| < 1$ ,  $\sigma > 0 \implies |z| > 1$ , and  $\sigma = 0 \implies |z| = 1$ .

Hence the LHP and the RHP in the  $s$ -plane map into inside and outside, respectively, of the unit circle in the  $z$ -plane and the  $j\omega$ -axis (Imaginary axis) in the  $s$ -plane maps into the unit circle in  $z$ -plane.

**12.7-1** Similar to the example in the text.

**12.7-2**

$$H[z] = \frac{z^n + 1}{z^n} = 1 + z^{-n}$$

The impulse response, the inverse  $z$ -transform of  $H[z]$ , is given by

$$h[k] = \delta[k] + \delta[k - n]$$

Fig. S12.7-2 shows the canonical realization of this filter.

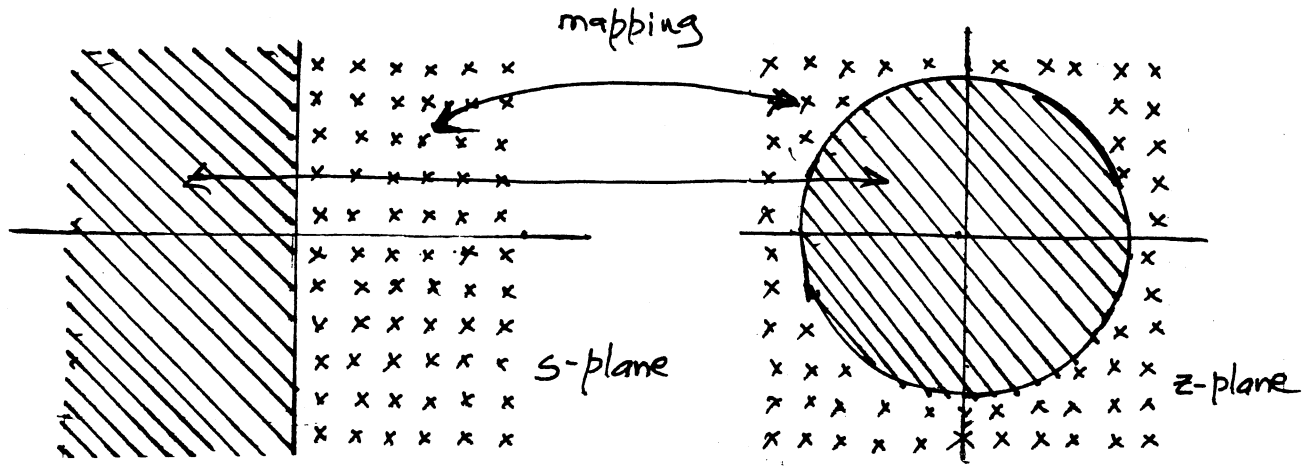

Figure S12.6-7

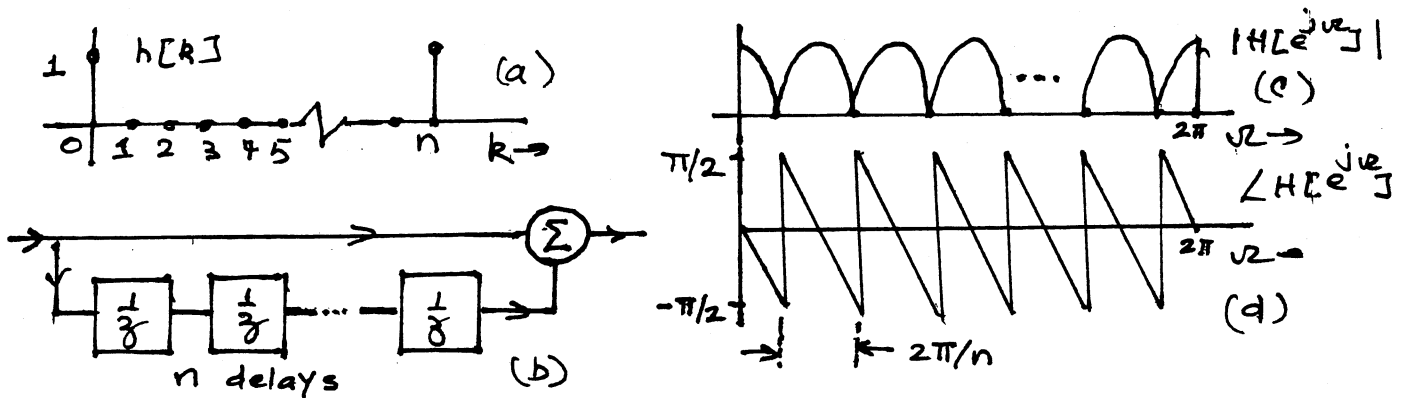

Figure S12.7-2

The frequency response is given by

$$\begin{aligned}
 H[e^{j\Omega}] &= 1 + e^{-jn\Omega} \\
 &= e^{-\frac{jn\Omega}{2}} (e^{\frac{jn\Omega}{2}} + e^{-\frac{jn\Omega}{2}}) \\
 &= 2e^{-\frac{jn\Omega}{2}} \cos\left(\frac{n\Omega}{2}\right)
 \end{aligned}$$

The amplitude and phase response are illustrated in Fig. S12.7-2c and S12.7-2d.

12.8-1 In this case,  $n = 14$  and  $N_0 = 15$ , Therefore  $\mathcal{F}_s = 200 \times 10^3$  and  $T = \frac{1}{\mathcal{F}_s} = 5 \times 10^{-6}$

We use the impulse response in Eq. (12.83), delay it by  $(N_0 - 1)/2 = 7$  and then truncate it by a 15-point window (over the interval  $0 \leq k \leq 14$ ) to make it causal. For the rectangular window,

$$h_R[k] = \frac{1}{2} \text{sinc}\left(\frac{\pi(k-7)}{2}\right) \quad 0 \leq k \leq 14$$

These values are tabulated in the Table below.

(b) We multiply the values of from the above equation by the Hamming window function

$$w_H[k] = 0.54 - 0.46 \cos\left(\frac{2\pi k}{N_0 - 1}\right) = 0.54 - 0.46 \cos\left(\frac{\pi k}{7}\right) \quad 0 \leq k \leq 14$$

The following Table also shows  $h_H[k]$  corresponding to the Hamming window.

Rectangular Window		Hamming Window	
$k$	$h_R[k]$	$w_H[k]$	$h_H[k]$
0	$-1/7\pi$	0.08	$-0.0114/\pi$
1	0	0.1255	0
2	$1/5\pi$	0.2532	$0.0506/\pi$
3	0	0.4376	0
4	$-1/3\pi$	0.6424	$-0.2141/\pi$
5	0	0.8268	0
6	$1/\pi$	0.9544	$0.9544/\pi$
7	$1/2$	1	
8	$1/\pi$	0.9544	$0.9544/\pi$
9	0	0.8268	0
10	$-1/3\pi$	0.6424	$-0.2141/\pi$
11	0	0.4376	0
12	$1/5\pi$	0.2532	$0.0506/\pi$
13	0	0.1255	0
14	$-1/7\pi$	0.08	$-0.0114/\pi$

and

$$H[z] = \sum_{k=0}^{14} h[k]z^{-k}$$

**12.8-2** In this case the highest frequency  $\omega_h = 1000$  rad/s. Hence the maximum value of  $T$  is:  $T_{\max} = \pi/1000$ . Let us choose  $T = 1/500 = 2$  ms. Using Eq. (12.81b), we obtain

$$h[k] = \frac{T}{2\pi} \int_{-\pi/T}^{\pi/T} H_a(j\omega) e^{jkT\omega} d\omega$$

Because of even symmetry of  $H_a(j\omega)$  (see Prob. 4.1-1)

$$\begin{aligned} h[k] &= \frac{2}{1000\pi} \int_0^{500\pi} H_a(j\omega) \cos kT\omega d\omega \\ &= \frac{1}{500\pi} \int_{800}^{1000} \cos kT\omega d\omega = \frac{1}{\pi k} \sin kT\omega \Big|_{800}^{1000} \\ &= \frac{\sin 2k - \sin 1.6k}{\pi k} \end{aligned}$$

To make this response causal, we now delay this response by  $(N_0 - 1)/2 = 5$  and to obtain  $h_R[k]$ , we truncate it beyond  $0 \leq k \leq 10$  to obtain

$$h[k] = \frac{\sin 2(k-5) - \sin 1.6(k-5)}{\pi(k-5)} \quad 0 \leq k \leq 10$$

and

$$H[z] = \sum_{k=0}^{10} h[k]z^{-k}$$

**12.8-3 (a)** The impulse response found in Example 12.11 is  $h[k] = \frac{1}{2} \frac{\sin(k\pi/2)}{(k\pi/2)}$ . We delay this response by  $(N_0 - 1)/2 = 2.5$  units and then truncate it with the fifth-order von Han window. The delayed response is

$$h_d[k] = \frac{1}{4} \frac{\sin[(k-2.5)\pi/2]}{[(k-2.5)\pi/2]} \left( 1 - \cos \frac{2\pi k}{6} \right)$$

The fifth-order von Hann window function is

$$w_v[k] = 0.5 \left[ 1 - \cos \frac{2\pi k}{5} \right] \quad 0 \leq k \leq 5$$

Hence von Hann window filter coefficients  $h_v[k]$  are:

$$h_v[k] = \frac{1}{4} \frac{\sin[(k - 2.5)\pi/2]}{[(k - 2.5)\pi/2]} \left( 1 - \cos \frac{2\pi k}{5} \right) \quad 0 \leq k \leq 5$$

Rectangular Window		von Hann Window	
$k$	$h_R[k]$	$w_v[k]$	$h_v[k]$
0	-0.09003	0	0
1	0.15	0.3455	0.05182
2	0.4501	0.9045	0.4071
3	0.4501	0.9045	0.4071
4	0.15	0.3455	0.05182
5	-0.09003	0	0

and hence:

$$H_v[e^{j\omega T}] = \sum_{k=0}^5 h_v[k] e^{-jkT\omega} = e^{-j2.5T\omega} \left[ 0.8142 \cos \frac{\omega T}{2} + 0.1036 \cos \frac{3\omega T}{2} \right]$$

(b) For example 12.12 (differentiator)

$$h[k] = \frac{\cos(k - 5)\pi}{(k - 5)T} \quad \text{and}$$

$$h_v[k] = \frac{\cos(k - 5)\pi}{2(k - 5)T} \left( 1 - \cos \frac{2k\pi}{10} \right) \quad 0 \leq k \leq 10$$

Rectangular Window		von Hann Window	
$k$	$h_R[k]$	$w_v[k]$	$h_v[k]$
0	$1/5T$	0	0
1	$-1/4T$	0.0955	$0.0239/T$
2	$1/3T$	0.3455	$0.115/T$
3	$-1/2T$	0.6545	$0.327/T$
4	$1/T$	0.9045	$0.9/T$
5	0	1	0
6	$-1/T$	0.9045	$-0.9/T$
7	$1/2T$	0.6545	$0.327/T$
8	$-1/3T$	0.3455	$-0.115/T$
9	$1/4T$	0.0955	$0.0239/T$
10	$-1/5T$	0	0

and



$$\begin{aligned}
H_v[e^{j\omega T}] &= \sum_{k=0}^{10} h_v[k] e^{jkT\omega} \\
&= e^{-j5T\omega} \left[ \frac{2}{T} 0.9 \sin T\omega - 0.327 \sin 2T\omega + 0.115 \sin 3T\omega - 0.0239 \sin 4T\omega \right]
\end{aligned}$$

12.8-4

$$\begin{aligned}
H_a(j\omega) &= 1e^{-j\pi/2} = -j \quad 0 < \omega < \pi/T \\
&= 1e^{j\pi/2} = j \quad 0 > \omega > -\pi/T
\end{aligned}$$

and from Eq. 912.81b)

$$\begin{aligned}
h[k] &= \frac{T}{2\pi} \int_{-\pi/T}^{\pi/T} H_a(j\omega) e^{j\omega kT} d\omega \\
&= \frac{T}{2\pi} \left[ \int_{-\pi/T}^0 j e^{j\omega kT} d\omega + \int_0^{\pi/T} -j e^{j\omega kT} d\omega \right] \\
&= \frac{1}{\pi k} (1 - \cos \pi k) = \begin{cases} 0 & k \text{ even} \\ \frac{2}{\pi k} & k \text{ odd} \end{cases}
\end{aligned}$$

We delay this response by  $(N_0 - 1)/2 = 7$  and then truncate it by a 15-point window to make it causal. For the rectangular window, we have

$$h_R[k] = \frac{1 - \cos \pi(k-7)}{\pi(k-7)} = \begin{cases} 0 & k \text{ odd} \\ \frac{2}{\pi(k-7)} & k \text{ even} \end{cases}$$

Hence

$$H_R[z] = \frac{2}{\pi} \sum_{k=0,2,4,\dots}^{14} \frac{1}{k-7} z^{-k}$$

and

$$\begin{aligned}
H_R[e^{j\omega T}] &= \frac{2}{\pi} \sum_{k=0,2,4,6,\dots}^{14} \frac{1}{k-7} e^{-jk\omega T} = \frac{2}{\pi} e^{-j7\omega T} \sum_{k=0,2,4,6,\dots}^{14} \frac{1}{k-7} e^{-j(k-7)\omega T} \\
&= \frac{2}{\pi} e^{-j7\omega T} \left[ (e^{-j\omega T} - e^{j\omega T}) + \frac{1}{3}(e^{-j3\omega T} - e^{j3\omega T}) + \frac{1}{5}(e^{-j5\omega T} - e^{j5\omega T}) + \frac{1}{7}(e^{-j7\omega T} - e^{j7\omega T}) \right] \\
&= \frac{-4j}{\pi} e^{-j7\omega T} \left[ \sin \omega T + \frac{1}{3} \sin 3\omega T + \frac{1}{5} \sin 5\omega T + \frac{1}{7} \sin 7\omega T \right]
\end{aligned}$$

Therefore

$$\begin{aligned}
\angle H_R[e^{j\omega T}] &= -\pi/2 - 7\omega T \quad \omega > 0 \\
&= \pi/2 - 7\omega T \quad \omega < 0
\end{aligned}$$

and

$$|H_R[e^{j\omega T}]| = \frac{4}{\pi} \left[ \sin \omega T + \frac{1}{3} \sin 3\omega T + \frac{1}{5} \sin 5\omega T + \frac{1}{7} \sin 7\omega T \right]$$

Also the Hamming window function is

$$w_H[k] = 0.54 - 0.46 \cos \left( \frac{2\pi k}{14} \right)$$

The corresponding Hamming filter transfer function is

$$H_H[z] = \frac{2}{\pi} \sum_{k=0,2,4,\dots}^{14} \frac{1}{k-7} \left( 0.54 - 0.46 \cos \frac{\pi k}{7} \right) z^{-k}$$

and

$$\begin{aligned} H_H[e^{j\omega T}] &= \frac{2}{\pi} e^{-7\omega T} \sum_{k=0,2,4,\dots}^{14} \frac{1}{k-7} \left( 0.54 - 0.46 \cos \frac{\pi k}{7} \right) e^{-j(k-7)\omega T} \\ &= -j e^{-7\omega T} (1.2152 \sin \omega T + 0.2726 \sin 3\omega T + 0.0644 \sin 5\omega T + 0.00144 \sin 7\omega T) \end{aligned}$$

Therefore

$$|H_H[e^{j\omega T}]| = [1.2152 \sin \omega T + 0.2726 \sin 3\omega T + 0.0644 \sin 5\omega T + 0.00144 \sin 7\omega T]$$

$$\angle H_H[e^{j\omega T}] = \begin{cases} -\pi/2 - 7\omega T & \omega > 0 \\ \pi/2 - 7\omega T & \omega < 0 \end{cases}$$

**12.8-5** In this case  $N_0 = n + 1 = 11$ . Hence,  $\omega_0 = \frac{2\pi}{11}$ . Moreover,  $H_a(j\omega) = j\omega$ . We multiply this spectrum by  $e^{-j\frac{N_0-1}{2}\omega T}$  (to accomplish the delay of  $h[k]$ ) and then take 11 uniform samples at the intervals of  $\omega_0$ . Hence, the samples are

$$H_r = jr\omega_0 e^{-j\frac{N_0-1}{2}r\omega_0 T} = jr \frac{2\pi}{11} e^{-j\frac{10\pi r T}{11}} \quad r = 0, 1, 2, 3, 4, 5$$

and because of conjugate symmetry

$$H_r = H_{11-r}^* = -j(11-r) \frac{2\pi}{11} e^{-j\frac{10\pi(11-r)T}{11}} \quad r = 6, 7, 8, 9, 10$$

Thus, the 11 spectral samples are

$$\begin{aligned} &0, \frac{j0.5712e^{-j2.856}}{T}, \frac{j1.1424e^{-j5.712}}{T}, \frac{j1.7136e^{-j8.568}}{T}, \frac{j2.2848e^{-j11.424}}{T}, \frac{j2.856e^{-j14.28}}{T}, \\ &\frac{-j2.856e^{j14.28}}{T}, \frac{-j2.2848e^{j11.424}}{T}, \frac{-j1.7136e^{j8.568}}{T}, \frac{-j1.1424e^{j5.712}}{T}, \frac{-j0.5712e^{j2.856}}{T} \end{aligned}$$

The IDFT of these samples is

$$h[k] = \frac{1}{11} \sum_{r=0}^{10} H_r e^{jk\omega_0 T} \quad k = 0, 1, 2, \dots, 10$$

We may use IFFT to compute these values as

$$\frac{-0.2885}{T}, \frac{0.3140}{T}, \frac{-0.3779}{T}, \frac{0.5282}{T}, \frac{-1.0137}{T}, 0, \frac{1.0137}{T}, \frac{-0.5282}{T}, \frac{0.3779}{T}, \frac{-0.3140}{T}, \frac{0.2885}{T}$$

Compare these values with those obtained in Example 12.11. Although the two sets are different, they are comparable.

# Chapter 13

---

13.1-1 (a)

$$\ddot{y} + 10\dot{y} + 2y = f$$

Choose:  $x_1 = y$  and  $x_2 = \dot{y} = \dot{x}_1 \Rightarrow \dot{x}_2 = \ddot{y}$

hence:  $\dot{x}_1 = x_2$

$$\dot{x}_2 = -2x_1 - 10x_2 + f$$

In matrix form we get:

$$\begin{bmatrix} \dot{x}_1 \\ \dot{x}_2 \end{bmatrix} = \begin{bmatrix} 0 & 1 \\ -2 & -10 \end{bmatrix} \begin{bmatrix} x_1 \\ x_2 \end{bmatrix} + \begin{bmatrix} 0 \\ 1 \end{bmatrix} f$$

(b)

$$\ddot{y} + 2e^4 \dot{y} + \log y = f$$

Let us choose:  $x_1 = y$  and  $x_2 = \dot{y} = \dot{x}_1$

hence:  $\dot{x}_1 = x_2$

hence:

$$\dot{x}_2 = -2e^{x_1} x_2 - \log x_1 + f$$

It is easy to see that this set is nonlinear.

(c)

$$\ddot{y} + \phi_1(y)\dot{y} + \phi_2(y)y = f$$

Let  $x_1 = y$  and  $x_2 = \dot{y}$ . Then

$$\dot{x}_1 = x_2$$

$$\dot{x}_2 = -\phi_1(x_1)x_2 - \phi_2(x_1)x_1 + f$$

Also in this case we are dealing with a nonlinear set, since  $\phi_2(x_1)$  and  $\phi_1(x_1)$  are not constants.

13.2-1 Writing the loop equations we get:

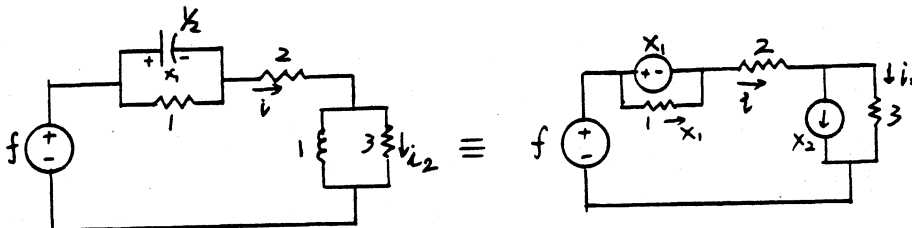

Figure S13.2-1

$$f = x_1 + 2i + 3i_2 \quad \text{where} \quad i_2 = \frac{f - x_1 - \dot{x}_2}{2} - x_2$$

$$\text{and} \quad i = \frac{f - x_1 - \dot{x}_2}{2}$$

$$\text{Also we have:} \quad \frac{1}{2}\dot{x}_1 = \frac{f - x_1 - \dot{x}_2}{2} - x_1$$

$$\text{Therefore} \quad \dot{x}_1 = f - x_1 - \dot{x}_2 - 2x_1 = -3x_1 - \dot{x}_2 + f \quad (1)$$

We can also write:

$$\dot{x}_2 = 3i_2 = 3 \left[ \frac{f - x_1 - \dot{x}_2}{2} - x_2 \right] = \frac{3}{2}f - \frac{3}{2}x_1 - \frac{3}{2}\dot{x}_2 - 3x_2$$

$$\text{Hence} \quad \frac{5}{2}\dot{x}_2 = -\frac{3}{2}x_1 - 3x_2 + \frac{3}{2}f$$

$$\text{or} \quad \dot{x}_2 = -\frac{3}{5}x_1 - \frac{6}{5}x_2 + \frac{3}{5}f \quad (2)$$

Substituting equation (2) in equation (1) we obtain:

$$\dot{x}_1 = -3x_1 + f - \left[ -\frac{3}{5}x_1 - \frac{6}{5}x_2 + \frac{3}{5}f \right] = -\frac{12}{5}x_1 + \frac{6}{5}x_2 + \frac{2}{5}f$$

Hence the state equations are:

$$\begin{bmatrix} \dot{x}_1 \\ \dot{x}_2 \end{bmatrix} = \begin{bmatrix} -\frac{12}{5} & \frac{6}{5} \\ -\frac{3}{5} & -\frac{6}{5} \end{bmatrix} \begin{bmatrix} x_1 \\ x_2 \end{bmatrix} + \begin{bmatrix} \frac{2}{5} \\ \frac{3}{5} \end{bmatrix} f(t)$$

**13.2-2** In the 1st loop, the current  $i_1$  can be computed as:

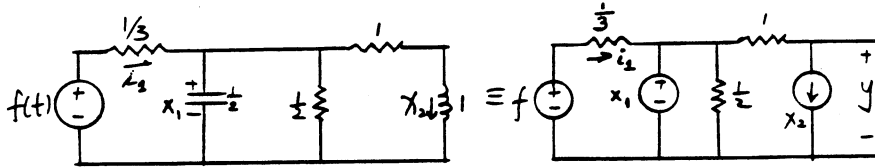

**Figure S13.2-2**

$$f = \frac{1}{3}i_1 + x_1 \Rightarrow i_1 = 3(f - x_1)$$

We also have: (using node equation)

$$\frac{1}{2}\dot{x}_1 = -2x_1 - x_2 - 3x_1 + 3f = -5x_1 - x_2 + 3f$$

$$\text{Hence} \quad \dot{x}_1 = -10x_1 - 2x_2 + 6f \quad (1)$$

Writing the equations in the rightmost loop we get:

$$x_1 = x_2 + \dot{x}_2 \quad \text{and} \quad \dot{x}_2 = x_1 - x_2 \quad (2)$$

Hence from (1) and (2) the state equations are found as:

$$\begin{bmatrix} \dot{x}_1 \\ \dot{x}_2 \end{bmatrix} = \begin{bmatrix} -10 & -2 \\ 1 & -1 \end{bmatrix} \begin{bmatrix} x_1 \\ x_2 \end{bmatrix} + \begin{bmatrix} 6 \\ 0 \end{bmatrix} f$$

The output equation is:  $y = \dot{x}_2 = x_1 - x_2$

$$\text{or} \quad y = [1 \quad -1] \begin{bmatrix} x_1 \\ x_2 \end{bmatrix}$$

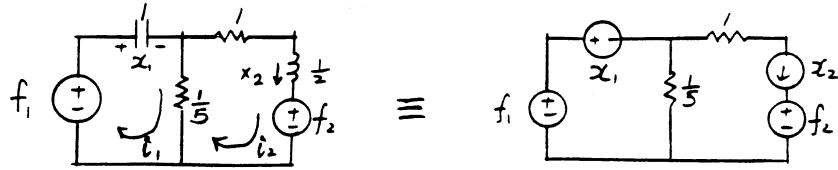

Figure S13.2-3

13.2-3 Let's choose the voltage across the capacitor and the current through the inductor as state variables  $x_1$  and  $x_2$ , respectively.

Writing the loop equations we get:

$$f_1 = x_1 + \frac{1}{5}[\dot{x}_1 - x_2]$$

Here we use the fact that:  $\dot{x}_1 = i_1$  and  $x_2 = i_2$ .

$$f_2 = -\frac{1}{2}\dot{x}_2 - x_2 + \frac{1}{5}[\dot{x}_1 - x_2]$$

And thus:  $\dot{x}_1 = -5x_1 + x_2 + 5f_1$

$$\dot{x}_2 = -2x_1 - 2x_2 + 2f_1 - 2f_2$$

Hence the state equations are

$$\begin{bmatrix} \dot{x}_1 \\ \dot{x}_2 \end{bmatrix} = \begin{bmatrix} -5 & 1 \\ -2 & -2 \end{bmatrix} \begin{bmatrix} x_1 \\ x_2 \end{bmatrix} + \begin{bmatrix} 5 & 0 \\ 2 & -2 \end{bmatrix} \begin{bmatrix} f_1 \\ f_2 \end{bmatrix}$$

13.2-4 The loop equations yield:

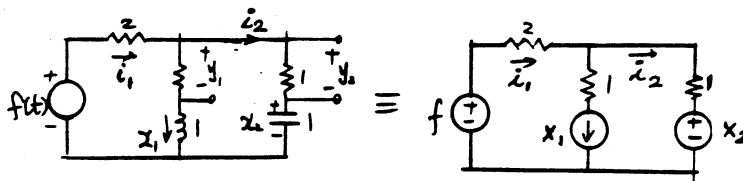

Figure S13.2-4

with  $i_2 = \dot{x}_2$  and  $i_1 = x_1 + i_2 = x_1 + \dot{x}_2$

$$f = 2i_1 + x_1 + \dot{x}_1 = 2x_1 + 2\dot{x}_2 + x_1 + \dot{x}_1 = 3x_1 + \dot{x}_1 + 2\dot{x}_2 \quad (1)$$

$$f = 2i_1 + \dot{x}_2 + x_2 = 2x_1 + 2\dot{x}_2 + \dot{x}_2 + x_2 = 2x_1 + x_2 + 3\dot{x}_2 \quad (2)$$

The last equation gives:

$$\dot{x}_2 = -\frac{2}{3}x_1 - \frac{1}{3}x_2 + \frac{1}{3}f \quad (3)$$

Substituting  $\dot{x}_2$  in the equation (1) we get:

$$\dot{x}_1 = -\frac{5}{3}x_1 + \frac{2}{3}x_2 + \frac{5}{3}f \quad (4)$$

From (3) and (4) the state equations are obtained as:

$$\begin{bmatrix} \dot{x}_1 \\ \dot{x}_2 \end{bmatrix} = \begin{bmatrix} -\frac{5}{3} & \frac{2}{3} \\ -\frac{2}{3} & -\frac{1}{3} \end{bmatrix} \begin{bmatrix} x_1 \\ x_2 \end{bmatrix} + \begin{bmatrix} \frac{5}{3} \\ \frac{1}{3} \end{bmatrix} f(t)$$

And the output equations are:  $y_1 = x_1$  and

$$y_2 = i_2 = \dot{x}_2 = -\frac{2}{3}x_1 - \frac{1}{3}x_2 + \frac{1}{3}f$$

$$y = \begin{bmatrix} y_1 \\ y_2 \end{bmatrix} = \begin{bmatrix} 1 & 0 \\ -\frac{2}{3} & -\frac{1}{3} \end{bmatrix} \begin{bmatrix} x_1 \\ x_2 \end{bmatrix} + \begin{bmatrix} 0 \\ \frac{1}{3} \end{bmatrix} f(t)$$

13.2-5

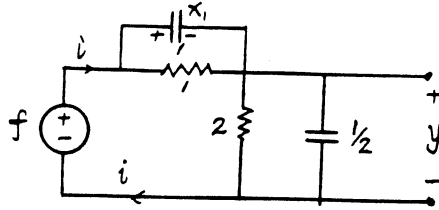

Figure S13.2-5

We have:

$$\begin{aligned} i &= x_1 + \dot{x}_1 \\ &= \frac{f - x_1}{2} + \frac{\dot{f} - \dot{x}_1}{2} \end{aligned}$$

Multiplying both sides of this equations by 2, we get:

$$\begin{aligned} 2x_1 + 2\dot{x}_1 &= f - x_1 + \dot{f} - \dot{x}_1 \\ \text{or } 3\dot{x}_1 &= -3x_1 + f + \dot{f} \\ \text{Hence } \dot{x}_1 &= -x_1 + \frac{f}{3} + \frac{\dot{f}}{3} \end{aligned}$$

Thus the only state equation is:

$$\dot{x}_1 = -x_1 + \frac{f}{3} + \frac{\dot{f}}{3}$$

The output equation is:  $y = -x_1 + f$ .

Note that although there are two capacitors, there is only one independent capacitor voltage, because the two capacitors form a loop with the voltage source. In such a case the state equation contains the terms  $f$  as well as  $\dot{f}$ . Similar situation exists when inductors along with current source(s) for a cut set.

13.2-6 Let us choose  $x_1$ ,  $x_2$  and  $x_3$  as the outputs of the subsystem shown in the figure:

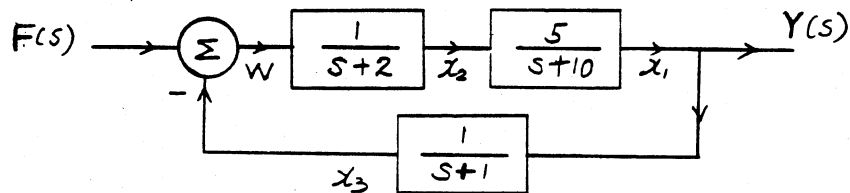

Figure S13.2-6

From the block diagram we obtain:

$$5x_2 = \dot{x}_1 + 10x_1 \implies \dot{x}_1 = -10x_1 + 5x_2 \quad (1)$$

$$x_1 = \dot{x}_3 + x_3 \implies \dot{x}_3 = x_1 - x_3 \quad (2)$$

$$w = \dot{x}_2 + 2x_2 \implies \dot{x}_2 = w - 2x_2$$

$$\dot{x}_2 = -2x_2 - x_3 + f \quad (3)$$

From (1), (2) and (3) the state equations can be written as:

$$\begin{bmatrix} \dot{x}_1 \\ \dot{x}_2 \\ \dot{x}_3 \end{bmatrix} = \begin{bmatrix} -10 & 5 & 0 \\ 0 & -2 & -1 \\ 1 & 0 & -1 \end{bmatrix} \begin{bmatrix} x_1 \\ x_2 \\ x_3 \end{bmatrix} + \begin{bmatrix} 0 \\ 1 \\ 0 \end{bmatrix} f$$

And the output equation is:

$$y = x_1 = \begin{bmatrix} 1 & 0 & 0 \end{bmatrix} \begin{bmatrix} x_1 \\ x_2 \\ x_3 \end{bmatrix}$$

**13.2-7** From Fig. P13.2-7, it is easy to write the state equations as:

$$\dot{x}_1 = \lambda_1 x_1$$

$$\dot{x}_2 = \lambda_2 x_2 + f_1$$

$$\dot{x}_3 = \lambda_3 x_3 + f_2$$

$$\dot{x}_4 = \lambda_4 x_4 + f_2$$

or

$$\begin{bmatrix} \dot{x}_1 \\ \dot{x}_2 \\ \dot{x}_3 \\ \dot{x}_4 \end{bmatrix} = \begin{bmatrix} \lambda_1 & 0 & 0 & 0 \\ 0 & \lambda_2 & 0 & 0 \\ 0 & 0 & \lambda_3 & 0 \\ 0 & 0 & 0 & \lambda_4 \end{bmatrix} \begin{bmatrix} x_1 \\ x_2 \\ x_3 \\ x_4 \end{bmatrix} + \begin{bmatrix} 0 & 0 \\ 1 & 0 \\ 0 & 1 \\ 0 & 1 \end{bmatrix} \begin{bmatrix} f_1 \\ f_2 \end{bmatrix}$$

The output equation is:

$$\begin{aligned} y_1 &= x_1 + x_2 \\ y_2 &= x_2 + x_3 \end{aligned} \implies \begin{bmatrix} y_1 \\ y_2 \end{bmatrix} = \begin{bmatrix} 1 & 1 & 0 & 0 \\ 0 & 1 & 1 & 0 \end{bmatrix} \begin{bmatrix} x_1 \\ x_2 \\ x_3 \\ x_4 \end{bmatrix}$$

**13.2-8**

$$H(s) = \frac{3s + 10}{s^2 + 7s + 12}$$

Controller canonical form:

We can write the state and output equations straightforward from the transfer function  $H(s)$ .

Thus we get:

$$\begin{bmatrix} \dot{x}_1 \\ \dot{x}_2 \end{bmatrix} = \begin{bmatrix} 0 & 1 \\ -12 & -7 \end{bmatrix} \begin{bmatrix} x_1 \\ x_2 \end{bmatrix} + \begin{bmatrix} 0 \\ 1 \end{bmatrix} f$$

$$y = \begin{bmatrix} 10 & 3 \end{bmatrix} \begin{bmatrix} x_1 \\ x_2 \end{bmatrix}$$

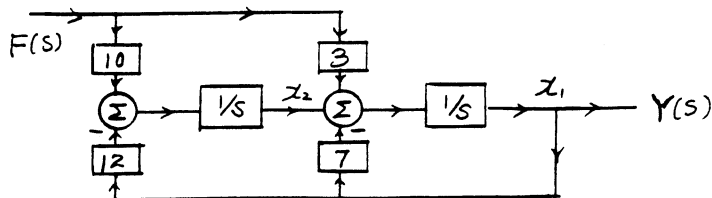

Figure S13.2-8a: observer canonical

Observer canonical form: In this case the block diagram can be drawn as shown in Fig. S6.10a.

hence:  $\dot{x}_1 = -7x_1 + x_2 + 3f$

$\dot{x}_2 = -12x_1 + 10f$

or

$$\begin{bmatrix} \dot{x}_1 \\ \dot{x}_2 \end{bmatrix} = \begin{bmatrix} -7 & 1 \\ -12 & 0 \end{bmatrix} \begin{bmatrix} x_1 \\ x_2 \end{bmatrix} + \begin{bmatrix} 3 \\ 10 \end{bmatrix} f$$

The output equation is:

$$y = x_1 = \begin{bmatrix} 1 & 0 \end{bmatrix} \begin{bmatrix} x_1 \\ x_2 \end{bmatrix}$$

The cascade form:

$$H(s) = \frac{3s + 10}{s^2 + 7s + 12} = \left( \frac{3s + 10}{s + 4} \right) \left( \frac{1}{s + 3} \right)$$

Hence we can write:

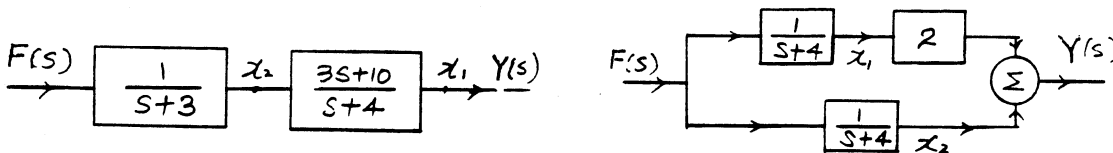

Figure S13.2-8b: cascade and parallel

$$\left. \begin{aligned} \dot{x}_1 + 4x_1 &= 3\dot{x}_2 + 10x_2 \\ \dot{x}_2 &= -3x_2 + f \end{aligned} \right\} \Rightarrow \begin{aligned} \dot{x}_1 &= -4x_1 - 9x_2 + 10x_2 + 3f \\ \dot{x}_2 &= -3x_2 + f \end{aligned}$$

$$\begin{bmatrix} \dot{x}_1 \\ \dot{x}_2 \end{bmatrix} = \begin{bmatrix} -4 & 1 \\ 0 & -3 \end{bmatrix} \begin{bmatrix} x_1 \\ x_2 \end{bmatrix} + \begin{bmatrix} 3 \\ 1 \end{bmatrix} f$$

and

$$y = x_1 = \begin{bmatrix} 1 & 0 \end{bmatrix} \begin{bmatrix} x_1 \\ x_2 \end{bmatrix}$$

Parallel form:

$$H(s) = \frac{2}{s + 4} + \frac{1}{s + 3}$$

$$\begin{aligned} \dot{x}_1 &= -4x_1 + f \\ \dot{x}_2 &= -3x_2 + f \end{aligned} \Rightarrow \begin{bmatrix} \dot{x}_1 \\ \dot{x}_2 \end{bmatrix} = \begin{bmatrix} -4 & 0 \\ 0 & -3 \end{bmatrix} \begin{bmatrix} x_1 \\ x_2 \end{bmatrix} + \begin{bmatrix} 1 \\ 1 \end{bmatrix} f$$

And the output equation is:

$$y = 2x_1 + x_2 = \begin{bmatrix} 2 & 1 \end{bmatrix} \begin{bmatrix} x_1 \\ x_2 \end{bmatrix}$$



13.2-9 (a)

$$H(s) = \frac{4s}{(s+1)(s+2)^2} = \frac{4s}{s^3 + 5s^2 + 8s + 4}$$

Controller canonical form:

$$\begin{bmatrix} \dot{x}_1 \\ \dot{x}_2 \\ \dot{x}_3 \end{bmatrix} = \begin{bmatrix} 0 & 1 & 0 \\ 0 & 0 & 1 \\ -4 & -8 & -5 \end{bmatrix} \begin{bmatrix} x_1 \\ x_2 \\ x_3 \end{bmatrix} + \begin{bmatrix} 0 \\ 0 \\ 1 \end{bmatrix} f$$

And

$$y = [0 \quad 4 \quad 0] \begin{bmatrix} x_1 \\ x_2 \\ x_3 \end{bmatrix}$$

Observer canonical form:

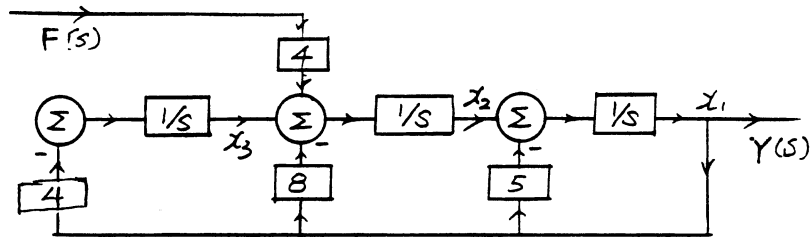

Fig. S13.2-9a: observer canonical

In this case:

$$\dot{x}_1 = -5x_1 + x_2$$

$$\dot{x}_2 = -8x_1 + x_3 + 4f$$

$$\dot{x}_3 = -x_1$$

$$\begin{bmatrix} \dot{x}_1 \\ \dot{x}_2 \\ \dot{x}_3 \end{bmatrix} = \begin{bmatrix} -5 & 1 & 0 \\ -8 & 0 & 1 \\ -4 & 0 & 0 \end{bmatrix} \begin{bmatrix} x_1 \\ x_2 \\ x_3 \end{bmatrix} + \begin{bmatrix} 0 \\ 4 \\ 0 \end{bmatrix} f$$

And:

$$y = x_1 = [1 \quad 0 \quad 0] \begin{bmatrix} x_1 \\ x_2 \\ x_3 \end{bmatrix}$$

Cascade form:

$$H(s) = \left( \frac{1}{s+1} \right) \left( \frac{4s}{s+2} \right) \left( \frac{1}{s+2} \right)$$

From the block diagram we have:

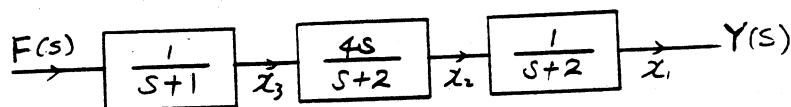

Figure S13.2-9a: cascade

$$\begin{aligned} \dot{x}_1 &= -2x_1 + x_2 \\ \dot{x}_2 + 2x_2 &= 4\dot{x}_3 \\ \dot{x}_3 &= -x_3 + f \end{aligned} \Rightarrow \begin{cases} \dot{x}_1 = -2x_1 + x_2 \\ \dot{x}_2 = -4x_3 - 2x_2 + 4f \\ \dot{x}_3 = -x_3 + f \end{cases}$$

$$\begin{bmatrix} \dot{x}_1 \\ \dot{x}_2 \\ \dot{x}_3 \end{bmatrix} = \begin{bmatrix} -2 & 1 & 0 \\ 0 & -2 & -4 \\ 0 & 0 & -1 \end{bmatrix} \begin{bmatrix} x_1 \\ x_2 \\ x_3 \end{bmatrix} + \begin{bmatrix} 0 \\ 4 \\ 1 \end{bmatrix} f$$

And the output:

$$y = x_1 = [1 \ 0 \ 0] \begin{bmatrix} x_1 \\ x_2 \\ x_3 \end{bmatrix}$$

Parallel form:

$$H(s) = \frac{-4}{s+1} + \frac{4}{s+2} + \frac{8}{(s+2)^2}$$

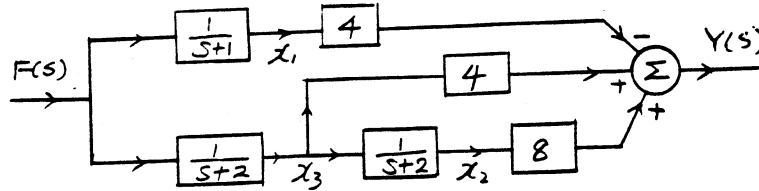

Figure S13.2-9a: parallel

We have:

$$\begin{aligned} \dot{x}_1 &= -x_1 + f \\ \dot{x}_2 &= -2x_2 + x_3 \\ \dot{x}_3 &= -2x_3 + f \end{aligned}$$

$$\begin{bmatrix} \dot{x}_1 \\ \dot{x}_2 \\ \dot{x}_3 \end{bmatrix} = \begin{bmatrix} -1 & 0 & 0 \\ 0 & -2 & 1 \\ 0 & 0 & -2 \end{bmatrix} \begin{bmatrix} x_1 \\ x_2 \\ x_3 \end{bmatrix} + \begin{bmatrix} 1 \\ 0 \\ 1 \end{bmatrix} f$$

And the output is:

$$y = -4x_1 + 8x_2 + 4x_3 = [-4 \ 8 \ 4] \begin{bmatrix} x_1 \\ x_2 \\ x_3 \end{bmatrix}$$

(b)

$$H(s) = \frac{s^3 + 7s^2 + 12s}{(s+1)^3(s+2)} = \frac{s^3 + 7s^2 + 12s}{s^4 + 5s^3 + 9s^2 + 7s + 2}$$

Controller canonical form:

Straightforward from  $H(s)$ , we have:

$$\begin{bmatrix} \dot{x}_1 \\ \dot{x}_2 \\ \dot{x}_3 \\ \dot{x}_4 \end{bmatrix} = \begin{bmatrix} 0 & 1 & 0 & 0 \\ 0 & 0 & 1 & 0 \\ 0 & 0 & 0 & 1 \\ -2 & -7 & -9 & -5 \end{bmatrix} \begin{bmatrix} x_1 \\ x_2 \\ x_3 \\ x_4 \end{bmatrix} + \begin{bmatrix} 0 \\ 0 \\ 0 \\ 1 \end{bmatrix} f$$

And the output is:

$$y = [0 \quad 12 \quad 7 \quad 1] \begin{bmatrix} x_1 \\ x_2 \\ x_3 \\ x_4 \end{bmatrix}$$

Observer canonical form:

We can write the state equation directly from  $H(s)$  as in the first canonical form.

$$\begin{bmatrix} \dot{x}_1 \\ \dot{x}_2 \\ \dot{x}_3 \\ \dot{x}_4 \end{bmatrix} = \begin{bmatrix} -5 & 1 & 0 & 0 \\ -9 & 0 & 1 & 0 \\ -7 & 0 & 0 & 1 \\ -2 & 0 & 0 & 0 \end{bmatrix} \begin{bmatrix} x_1 \\ x_2 \\ x_3 \\ x_4 \end{bmatrix} + \begin{bmatrix} 1 \\ 7 \\ 12 \\ 0 \end{bmatrix} f$$

And

$$y = x_1 = [1 \quad 0 \quad 0 \quad 0] \begin{bmatrix} x_1 \\ x_2 \\ x_3 \\ x_4 \end{bmatrix}$$

Cascade form:

$$H(s) = \frac{s(s+3)(s+4)}{(s+2)(s+1)^3} = \left( \frac{1}{s+2} \right) \left( \frac{s}{s+1} \right) \left( \frac{s+3}{s+1} \right) \left( \frac{s+4}{s+1} \right)$$

Cascade form: From the block diagram we obtain:

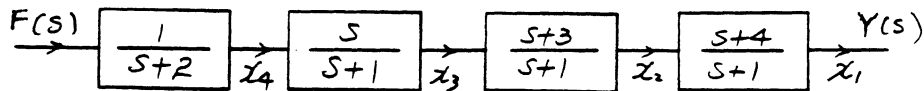

Figure S13.2-9b: cascade

$$\begin{cases} \dot{x}_1 + x_1 = \dot{x}_2 + 4x_2 \\ \dot{x}_2 + x_2 = \dot{x}_3 + 3x_3 \\ \dot{x}_3 = -x_3 + \dot{x}_4 \\ \dot{x}_4 = -2x_4 + f \end{cases} \Rightarrow \begin{cases} \dot{x}_1 = -x_1 + 4x_2 - x_2 + 2x_3 - 2x_4 + f \\ \dot{x}_2 = -x_2 + 3x_3 - x_3 - 2x_4 + f \\ \dot{x}_3 = -x_3 - 2x_4 + f \\ \dot{x}_4 = -2x_4 + f \end{cases}$$

hence:

$$\begin{bmatrix} \dot{x}_1 \\ \dot{x}_2 \\ \dot{x}_3 \\ \dot{x}_4 \end{bmatrix} = \begin{bmatrix} -1 & 3 & 2 & -2 \\ 0 & -1 & 2 & -2 \\ 0 & 0 & -1 & -2 \\ 0 & 0 & 0 & -2 \end{bmatrix} \begin{bmatrix} x_1 \\ x_2 \\ x_3 \\ x_4 \end{bmatrix} + \begin{bmatrix} 1 \\ 1 \\ 1 \\ 1 \end{bmatrix} f$$

And

$$y = x_1 = [1 \quad 0 \quad 0 \quad 0] \begin{bmatrix} x_1 \\ x_2 \\ x_3 \\ x_4 \end{bmatrix}$$

Parallel form: we can rewrite  $H(s)$  as (after partial fraction expansion)

$$H(s) = \frac{6}{s+2} + \frac{11}{s+1} + \frac{7}{(s+1)^2} - \frac{6}{(s+1)^3}$$

$$\dot{x}_1 = -2x_1 + f$$

$$\dot{x}_2 = -x_2 + x_3$$

$$\dot{x}_3 = -x_3 + x_4$$

$$\dot{x}_4 = -x_4 + f$$

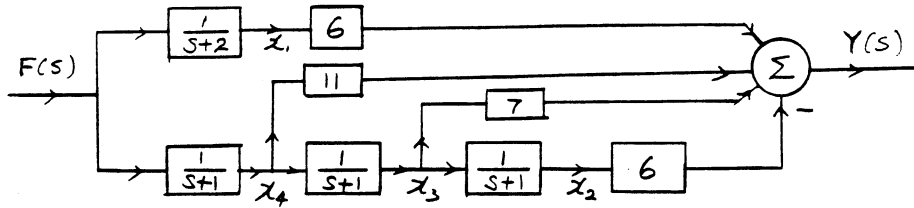

Figure S13.2-9b: parallel

From the block diagram, we have

$$\begin{bmatrix} \dot{x}_1 \\ \dot{x}_2 \\ \dot{x}_3 \\ \dot{x}_4 \end{bmatrix} = \begin{bmatrix} -2 & 0 & 0 & 0 \\ 0 & -2 & 1 & 0 \\ 0 & 0 & -1 & 1 \\ 0 & 0 & 0 & -1 \end{bmatrix} \begin{bmatrix} x_1 \\ x_2 \\ x_3 \\ x_4 \end{bmatrix} + \begin{bmatrix} 1 \\ 0 \\ 0 \\ 1 \end{bmatrix} f$$

And the output can be written as:

$$y = 6x_1 - 6x_2 + 7x_3 + 11x_4$$

or

$$y = \begin{bmatrix} 6 & -6 & 7 & 11 \end{bmatrix} \begin{bmatrix} x_1 \\ x_2 \\ x_3 \\ x_4 \end{bmatrix}$$

### 13.3-1

$$\dot{\mathbf{x}} = \mathbf{Ax} + \mathbf{Bf}$$

The solution of the state equation in the frequency domain is given by:

$$\mathbf{x}(s) = \Phi(s)\mathbf{x}(0) + \Phi(s)\mathbf{B}\mathbf{F}(s)$$

but in this case  $f(t) = 0 \implies F(s) = 0$

hence:  $\mathbf{x}(s) = \Phi(s)\mathbf{x}(0)$  where  $\Phi(s) = (s\mathbf{I} - \mathbf{A})^{-1}$

$$\Phi(s) = (s\mathbf{I} - \mathbf{A})^{-1} \quad (s\mathbf{I} - \mathbf{A}) = \begin{bmatrix} s & 0 \\ 0 & s \end{bmatrix} - \begin{bmatrix} 0 & 2 \\ -1 & -3 \end{bmatrix}$$

$$s\mathbf{I} - \mathbf{A} = \begin{bmatrix} s & -2 \\ 1 & s+3 \end{bmatrix} \implies \Phi(s) = (s\mathbf{I} - \mathbf{A})^{-1} = \begin{bmatrix} s+3 & 2 \\ -1 & s \end{bmatrix} \frac{1}{s^2 + 3s + 2}$$

$$\Phi(s) = \begin{bmatrix} \frac{s+3}{s^2+3s+2} & \frac{2}{s^2+3s+2} \\ \frac{-1}{s^2+3s+2} & \frac{s}{s^2+3s+2} \end{bmatrix} = \begin{bmatrix} \frac{s+3}{(s+1)(s+2)} & \frac{2}{(s+1)(s+2)} \\ \frac{-1}{(s+1)(s+2)} & \frac{s}{(s+1)(s+2)} \end{bmatrix}$$

And hence:  $\mathbf{x}(s) = \Phi(s)\mathbf{x}(0)$

$$\mathbf{x}(s) = \begin{bmatrix} \frac{2(s+3)+2}{(s+1)(s+2)} \\ \frac{-2+s}{(s+1)(s+2)} \end{bmatrix} = \begin{bmatrix} \frac{2s+8}{(s+1)(s+2)} \\ \frac{s-2}{(s+1)(s+2)} \end{bmatrix} = \begin{bmatrix} \frac{6}{s+1} - \frac{4}{s+2} \\ \frac{-3}{s+1} + \frac{4}{s+2} \end{bmatrix}$$

And finally:

$$\mathbf{x}(t) = \begin{bmatrix} x_1(t) \\ x_2(t) \end{bmatrix} = \mathcal{L}^{-1}[\mathbf{x}(s)] = \begin{bmatrix} (6e^{-t} - 4e^{-2t})u(t) \\ (-3e^{-t} + 4e^{-2t})u(t) \end{bmatrix}$$

13.3-2

$$\mathbf{x}(s) = \Phi(s)\mathbf{x}(0) + \Phi(s)\mathbf{BF}(s) = \Phi(s)[\mathbf{x}(0) + \mathbf{BF}(s)]$$

$$(s\mathbf{I} - \mathbf{A}) = \begin{bmatrix} s+5 & 6 \\ -1 & s \end{bmatrix} \quad \text{and} \quad \Phi(s) = (s\mathbf{I} - \mathbf{A})^{-1} = \frac{1}{s^2 + 5s + 6} \begin{bmatrix} s & -6 \\ 1 & s+5 \end{bmatrix}$$

$$\Phi(s) = \begin{bmatrix} \frac{s}{(s+3)(s+2)} & \frac{-6}{(s+3)(s+2)} \\ \frac{1}{(s+3)(s+2)} & \frac{s+5}{(s+3)(s+2)} \end{bmatrix}$$

And hence:

$$\begin{aligned} \mathbf{x}(s) &= \Phi(s)[\mathbf{x}(0) + \mathbf{BF}(s)] = \begin{bmatrix} \frac{s}{(s+3)(s+2)} & \frac{-6}{(s+3)(s+2)} \\ \frac{1}{(s+3)(s+2)} & \frac{s+5}{(s+3)(s+2)} \end{bmatrix} \begin{bmatrix} 5 + \frac{100}{s^2+10^4} \\ 4 \end{bmatrix} \\ &= \begin{bmatrix} \frac{-34.02}{s+2} + \frac{39.03}{s+3} - \frac{10^{-2}s}{s^2+10^4} \\ \frac{17.01}{s+2} - \frac{13.01}{s+3} - \frac{0}{s^2+10^4} \end{bmatrix} \end{aligned}$$

hence:  $\mathbf{x}(t) = \mathcal{L}^{-1}(\mathbf{x}(s))$

$$\mathbf{x}(s) = \begin{bmatrix} x_1(t) \\ x_2(t) \end{bmatrix} = \begin{bmatrix} -34.02e^{-2t} + 39.03e^{-3t} - 0.01 \cos 100t \\ 17.01e^{-2t} - 13.01e^{-3t} \end{bmatrix}$$

13.3-3

$$\mathbf{x}(s) = \Phi(s)[\mathbf{x}(0) + \mathbf{BF}(s)]$$

$$\begin{aligned} (s\mathbf{I} - \mathbf{A}) &= \begin{bmatrix} s+2 & 0 \\ -1 & s+1 \end{bmatrix} \quad \text{and} \quad \Phi(s) = (s\mathbf{I} - \mathbf{A})^{-1} = \frac{1}{(s+1)(s+2)} \begin{bmatrix} s+1 & 0 \\ 1 & s+2 \end{bmatrix} \\ &= \begin{bmatrix} \frac{1}{s+2} & 0 \\ \frac{1}{(s+1)(s+2)} & \frac{1}{s+1} \end{bmatrix} \end{aligned}$$

Also  $f(t) = u(t) \Rightarrow F(s) = \frac{1}{s}$

$$\text{Hence:} \quad \mathbf{BF}(s) = \begin{bmatrix} \frac{1}{s} \\ 0 \end{bmatrix} \quad \text{And} \quad \mathbf{x}(0) + \mathbf{BF}(s) = \begin{bmatrix} \frac{1}{s} \\ -1 \end{bmatrix}$$

And thus:

$$\begin{aligned} \mathbf{x}(s) &= \begin{bmatrix} \frac{1}{s+2} & 0 \\ \frac{1}{(s+1)(s+2)} & \frac{1}{s+1} \end{bmatrix} \begin{bmatrix} \frac{1}{s} \\ -1 \end{bmatrix} = \begin{bmatrix} \frac{1}{s(s+2)} \\ \frac{1}{s(s+1)(s+2)} - \frac{1}{s+1} \end{bmatrix} \\ &= \begin{bmatrix} \frac{1}{2s} - \frac{1}{2(s+2)} \\ \frac{1}{2s} - \frac{2}{s+1} - \frac{1}{2(s+2)} \end{bmatrix} \end{aligned}$$

Hence:

$$\mathbf{x}(t) = \mathcal{L}^{-1}(\mathbf{x}(s)) = \begin{bmatrix} x_1(t) \\ x_2(t) \end{bmatrix} = \begin{bmatrix} (\frac{1}{2} - \frac{1}{2}e^{-2t})u(t) \\ (\frac{1}{2} - 2e^{-t} + \frac{1}{2}e^{-2t})u(t) \end{bmatrix}$$

## 13.3-4

$$\mathbf{x}(s) = \Phi(s)[\mathbf{x}(0) + \mathbf{B}\mathbf{F}(s)]$$

$$(s\mathbf{I} - \mathbf{A}) = \begin{bmatrix} s+1 & -1 \\ 0 & s+2 \end{bmatrix} \text{ and } \Phi(s) = (s\mathbf{I} - \mathbf{A})^{-1} = \frac{1}{(s+1)(s+2)} \begin{bmatrix} s+2 & 1 \\ 0 & s+1 \end{bmatrix}$$

$$\Phi(s) = \begin{bmatrix} \frac{1}{s+1} & \frac{1}{(s+1)(s+2)} \\ 0 & \frac{1}{s+2} \end{bmatrix}$$

$$\text{and } f(t) = \begin{bmatrix} u(t) \\ \delta(t) \end{bmatrix} \Rightarrow \mathbf{F}(s) = \begin{bmatrix} \frac{1}{s} \\ 1 \end{bmatrix}$$

$$\mathbf{B}\mathbf{F}(s) = \begin{bmatrix} 1 & 1 \\ 0 & 1 \end{bmatrix} \begin{bmatrix} \frac{1}{s} \\ 1 \end{bmatrix} = \begin{bmatrix} \frac{s+1}{s} \\ 1 \end{bmatrix}$$

$$\text{and: } \mathbf{x}(0) + \mathbf{B}\mathbf{F}(s) = \begin{bmatrix} \frac{s+1}{s} + 1 \\ 3 \end{bmatrix} = \begin{bmatrix} \frac{2s+1}{s} + 1 \\ 3 \end{bmatrix}$$

$$\begin{aligned} \mathbf{x}(s) &= \Phi(s)[\mathbf{x}(0) + \mathbf{B}\mathbf{F}(s)] = \begin{bmatrix} \frac{1}{s+1} & \frac{1}{(s+1)(s+2)} \\ 0 & \frac{1}{s+2} \end{bmatrix} \begin{bmatrix} \frac{2s+1}{s} \\ 3 \end{bmatrix} \\ &= \begin{bmatrix} \frac{(2s+1)(s+2)+3s}{s(s+1)(s+2)} \\ \frac{3}{s+2} \end{bmatrix} = \begin{bmatrix} \frac{1}{s} + \frac{4}{s+1} - \frac{3}{s+2} \\ \frac{3}{s+2} \end{bmatrix} \end{aligned}$$

And hence:

$$\mathbf{x}(t) = \mathcal{L}^{-1}(\mathbf{x}(s)) = \begin{bmatrix} x_1(t) \\ x_2(t) \end{bmatrix} = \begin{bmatrix} (1 + 4e^{-t} - 3e^{-2t})u(t) \\ 3e^{-2t}u(t) \end{bmatrix}$$

## 13.3-5

$$\mathbf{Y}(s) = \mathbf{C}\mathbf{x}(s) + \mathbf{D}\mathbf{F}(s) = \mathbf{C}\Phi(s)\mathbf{x}(0) + [\mathbf{C}\Phi(s)\mathbf{B} + \mathbf{D}]\mathbf{F}(s)$$

$$(s\mathbf{I} - \mathbf{A}) = \begin{bmatrix} s+3 & -1 \\ 2 & s \end{bmatrix} \text{ and } \Phi(s) = (s\mathbf{I} - \mathbf{A})^{-1} = \frac{1}{(s+1)(s+2)} \begin{bmatrix} s & 1 \\ -2 & s+3 \end{bmatrix}$$

$$\Phi(s) = \begin{bmatrix} \frac{s}{(s+1)(s+2)} & \frac{1}{(s+1)(s+2)} \\ \frac{-2}{(s+1)(s+2)} & \frac{s+3}{(s+1)(s+2)} \end{bmatrix} \text{ and } \mathbf{B}\mathbf{F}(s) = \begin{bmatrix} \frac{1}{s} \\ 1 \end{bmatrix}$$

Since  $\mathbf{D} = 0 \Rightarrow \mathbf{Y}(s) = \mathbf{C}\Phi(s)[\mathbf{x}(0) + \mathbf{B}\mathbf{F}(s)]$

$$\text{So } \mathbf{x}(0) + \mathbf{B}\mathbf{F}(s) = \begin{bmatrix} 2 + \frac{1}{s} \\ 0 \end{bmatrix} = \begin{bmatrix} \frac{2s+1}{s} \\ 0 \end{bmatrix}$$

and

$$\Phi(s)[\mathbf{x}(0) + \mathbf{B}\mathbf{F}(s)] = \begin{bmatrix} \frac{s}{(s+1)(s+2)} & \frac{1}{(s+1)(s+2)} \\ \frac{-2}{(s+1)(s+2)} & \frac{s+3}{(s+1)(s+2)} \end{bmatrix} \begin{bmatrix} \frac{2s+1}{s} \\ 0 \end{bmatrix} = \begin{bmatrix} \frac{2s+1}{(s+1)(s+2)} \\ \frac{-2(2s+1)}{s(s+1)(s+2)} \end{bmatrix}$$

$$\mathbf{Y}(s) = \mathbf{C}\Phi(s)[\mathbf{x}(0) + \mathbf{B}\mathbf{F}(s)] = [0 \quad 1] \begin{bmatrix} \frac{2s+1}{(s+1)(s+2)} \\ \frac{-2(2s+1)}{s(s+1)(s+2)} \end{bmatrix}$$

$$\mathbf{Y}(s) = \frac{-4s-2}{s(s+1)(s+2)} = \frac{-1}{s} - 2 \cdot \frac{1}{s+1} + \frac{3}{s+2}$$

$$y(t) = \mathcal{L}^{-1}[y(s)] = (-1 - 2e^{-t} + 3e^{-2t})u(t)$$

## 13.3-6

$$\begin{aligned} \mathbf{y}(s) &= \mathbf{C}\mathbf{x}(s) + \mathbf{D}\mathbf{F}(s) = \mathbf{C}\Phi(s)\mathbf{x}(0) + [\mathbf{C}\Phi(s)\mathbf{B} + \mathbf{D}]\mathbf{F}(s) \\ &= \mathbf{C}\{\Phi(s)[\mathbf{x}(0) + \mathbf{B}\mathbf{F}(s)]\} + \mathbf{D}\mathbf{F}(s) \end{aligned}$$

$$(s\mathbf{I} - \mathbf{A}) = \begin{bmatrix} s+1 & -1 \\ 1 & s+1 \end{bmatrix} \text{ and } \Phi(s) = (s\mathbf{I} - \mathbf{A})^{-1} = \frac{1}{s^2 + 2s + 2} \begin{bmatrix} s+1 & 1 \\ -1 & s+1 \end{bmatrix}$$

$$= \begin{bmatrix} \frac{s+1}{s^2+2s+2} & \frac{1}{s^2+2s+2} \\ \frac{-1}{s^2+2s+2} & \frac{s+1}{s^2+2s+2} \end{bmatrix}$$

$$\mathbf{BF}(s) = \begin{bmatrix} 0 \\ \frac{1}{s} \end{bmatrix} \quad \text{and} \quad \mathbf{x}(0) + \mathbf{BF}(s) = \begin{bmatrix} 2 \\ \frac{s+1}{s} \end{bmatrix}$$

$$\text{Hence } \Phi(s)[\mathbf{x}(0) + \mathbf{BF}(s)] = \begin{bmatrix} \frac{s+1}{(s+1)^2+1} & \frac{1}{(s+1)^2+1} \\ \frac{-1}{(s+1)^2+1} & \frac{s+1}{(s+1)^2+1} \end{bmatrix} \begin{bmatrix} 2 \\ \frac{s+1}{s} \end{bmatrix}$$

$$= \begin{bmatrix} \frac{2(s+1)}{(s+1)^2+1} + \frac{s+1}{s[(s+1)^2+1]} \\ \frac{-2}{(s+1)^2+1} + \frac{(s+1)^2}{s[(s+1)^2+1]} \end{bmatrix} = \begin{bmatrix} \frac{2s^2+3s+1}{s[(s+1)^2+1]} \\ \frac{s^2+1}{s[(s+1)^2+1]} \end{bmatrix}$$

$$\mathbf{C}\Phi(s)[\mathbf{x}(0) + \mathbf{BF}(s)] = [1 \quad 1] \Phi(s)[\mathbf{x}(0) + \mathbf{BF}(s)] = \left[ \frac{2s^2 + 3s + 1 + s^2 + 1}{s\{(s+1)^2 + 1\}} \right]$$

Also:  $\mathbf{DF}(s) = \frac{1}{s}$

Hence

$$\mathbf{Y}(s) = \mathbf{C}\Phi(s)[\mathbf{x}(0) + \mathbf{BF}(s)] + \mathbf{DF}(s) = \frac{3s^2 + 3s + 2}{s\{(s+1)^2 + 1\}} + \frac{1}{s} = \frac{4s^2 + 5s + 4}{s\{(s+1)^2 + 1\}}$$

$$Y(s) = \frac{4s^2 + 5s + 4}{s(s^2 + 2s + 2)} = \frac{\mathbf{C}}{s} + \frac{\mathbf{As} + \mathbf{B}}{s^2 + 2s + 2}$$

Using partial fractions and clearing fractions we get:

$$Y(s) = \frac{2}{s} + \frac{2s+1}{(s+1)^2+1^2} = \frac{2}{s} + 2\frac{(s+1)}{(s+1)^2+1^2} - \frac{1}{(s+1)^2+1^2}$$

$$\text{and } y(t) = \mathcal{L}^{-1}[Y(s)] = (2 + 2e^{-t} \cos t - e^{-t} \sin t)u(t)$$

### 13.3-7

$$H(s) = \left( \frac{1}{s+3} \right) \left( \frac{3s+10}{s+4} \right) = \frac{3s+10}{s^2+7s+12}$$

This is the same transfer function as in Prob. 13.2-8, where the cascade form state equations were found to be

$$\begin{bmatrix} \dot{x}_1 \\ \dot{x}_2 \end{bmatrix} = \begin{bmatrix} -4 & 1 \\ 0 & -3 \end{bmatrix} \begin{bmatrix} x_1 \\ x_2 \end{bmatrix} + \begin{bmatrix} 3 \\ 1 \end{bmatrix} f$$

$$\text{And } y = x_1 = [1 \quad 0] \begin{bmatrix} x_1 \\ x_2 \end{bmatrix}$$

In this case

$$s\mathbf{I} - \mathbf{A} = \begin{bmatrix} s+4 & -1 \\ 0 & s+3 \end{bmatrix} \text{ and } \Phi(s) = (s\mathbf{I} - \mathbf{A})^{-1} = \frac{1}{(s+3)(s+4)} \begin{bmatrix} s+3 & 1 \\ 0 & s+4 \end{bmatrix}$$

$$= \begin{bmatrix} \frac{1}{s+4} & \frac{1}{(s+3)(s+4)} \\ 0 & \frac{1}{s+3} \end{bmatrix}$$

Also in our case:

$$\mathbf{C} = [1 \quad 0] \quad \text{and} \quad \mathbf{B} = \begin{bmatrix} 3 \\ 1 \end{bmatrix} \quad \text{and} \quad \mathbf{D} = 0$$

Hence

$$\Phi(s)\mathbf{B} = \begin{bmatrix} \frac{1}{s+4} & \frac{1}{(s+3)(s+4)} \\ 0 & \frac{1}{s+3} \end{bmatrix} \begin{bmatrix} 3 \\ 1 \end{bmatrix} = \begin{bmatrix} \frac{3(s+3)+1}{(s+3)(s+4)} \\ \frac{1}{s+3} \end{bmatrix} = \begin{bmatrix} \frac{3s+10}{(s+3)(s+4)} \\ \frac{1}{s+3} \end{bmatrix}$$

$$\text{And } \mathbf{C}\Phi(s)\mathbf{B} = [1 \ 0] \begin{bmatrix} \frac{3s+10}{(s+3)(s+4)} \\ \frac{1}{s+3} \end{bmatrix} = \frac{3s+10}{(s+3)(s+4)}$$

$$\text{Hence: } \mathbf{C}\Phi(s)\mathbf{B} = \frac{3s+10}{s^2+7s+12} = H(s)$$

13.3-8

$$H(s) = \mathbf{C}\Phi(s)\mathbf{B} + \mathbf{D}$$

in Prob. 13.3-5 we have found  $\Phi(s)$ . And

$$\Phi(s)\mathbf{B} = \begin{bmatrix} \frac{s}{(s+1)(s+2)} & \frac{1}{(s+1)(s+2)} \\ \frac{-2}{(s+1)(s+2)} & \frac{s+3}{(s+1)(s+2)} \end{bmatrix} \begin{bmatrix} 1 \\ 0 \end{bmatrix} = \begin{bmatrix} \frac{s}{(s+1)(s+2)} \\ \frac{-2}{(s+1)(s+2)} \end{bmatrix}$$

Hence

$$\mathbf{C}\Phi(s)\mathbf{B} = [1 \ 0] \Phi(s)\mathbf{B} = \frac{-2}{(s+1)(s+2)} \quad \text{and since } \mathbf{D} = 0$$

$$H(s) = \mathbf{C}\Phi(s)\mathbf{B} = \frac{-2}{s^2+3s+2}$$

13.3-9 From Prob. 13.3-6,

$$\Phi(s)\mathbf{B} = \begin{bmatrix} \frac{s+1}{(s+1)^2+1} & \frac{1}{(s+1)^2+1} \\ \frac{-1}{(s+1)^2+1} & \frac{s+1}{(s+1)^2+1} \end{bmatrix} \begin{bmatrix} 0 \\ 1 \end{bmatrix} = \begin{bmatrix} \frac{1}{(s+1)^2+1} \\ \frac{s+1}{(s+1)^2+1} \end{bmatrix}$$

And:

$$\mathbf{C}\Phi(s)\mathbf{B} = [1 \ 1] = \begin{bmatrix} \frac{1}{(s+1)^2+1} \\ \frac{s+1}{(s+1)^2+1} \end{bmatrix} = \frac{s+1+1}{(s+1)^2+1} = \frac{s+2}{(s+1)^2+1}$$

And

$$H(s) = \mathbf{C}\Phi(s)\mathbf{B} + \mathbf{D} = \frac{s+2}{(s+1)^2+1} + 1 = \frac{s^2+3s+4}{s^2+2s+2}$$

13.3-10 In this case:

$$\begin{aligned} s\mathbf{I} - \mathbf{A} &= \begin{bmatrix} s & -1 \\ 1 & s+2 \end{bmatrix} \quad \text{and } \Phi(s) = (s\mathbf{I} - \mathbf{A})^{-1} = \frac{1}{(s+1)^2} \begin{bmatrix} s+2 & 1 \\ -1 & s \end{bmatrix} \\ &= \begin{bmatrix} \frac{s+2}{(s+1)^2} & \frac{1}{(s+1)^2} \\ \frac{-1}{(s+1)^2} & \frac{s}{(s+1)^2} \end{bmatrix} \end{aligned}$$

And:

$$\Phi(s)\mathbf{B} = \begin{bmatrix} \frac{s+2}{(s+1)^2} & \frac{1}{(s+1)^2} \\ \frac{-1}{(s+1)^2} & \frac{s}{(s+1)^2} \end{bmatrix} \begin{bmatrix} 0 & 1 \\ 1 & 0 \end{bmatrix} = \begin{bmatrix} \frac{1}{(s+1)^2} & \frac{s+2}{(s+1)^2} \\ \frac{s}{(s+1)^2} & \frac{-1}{(s+1)^2} \end{bmatrix}$$

$$\mathbf{C}\Phi(s)\mathbf{B} = \begin{bmatrix} 1 & 2 \\ 4 & 1 \\ 1 & 1 \end{bmatrix} \begin{bmatrix} \frac{1}{(s+1)^2} & \frac{s+2}{(s+1)^2} \\ \frac{s}{(s+1)^2} & \frac{-1}{(s+1)^2} \end{bmatrix}$$

$$\text{and } H(s) = \mathbf{C}\Phi(s)\mathbf{B} + \mathbf{D} = \begin{bmatrix} \frac{2s+1}{(s+1)^2} & \frac{s}{(s+1)^2} \\ \frac{4+s}{(s+1)^2} & \frac{4s+7}{(s+1)^2} \\ \frac{1}{s+1} & \frac{1}{s+1} \end{bmatrix}$$



13.3-11 In the time domain, the solution  $\mathbf{x}(t)$  is given by:

$$\mathbf{x}(t) = e^{\mathbf{A}t}\mathbf{x}(0) + \int_0^t e^{\mathbf{A}(t-\tau)}\mathbf{B}\mathbf{f}(\tau) d\tau$$

$$\mathbf{x}(t) = e^{\mathbf{A}t}\mathbf{x}(0) + e^{\mathbf{A}t} * \mathbf{B}\mathbf{f}(t)$$

where:

$$e^{\mathbf{A}t} = \mathcal{L}^{-1}[(s\mathbf{I} - \mathbf{A})^{-1}] = \mathcal{L}^{-1}(\Phi(s))$$

From Prob. 13.3-1 we have found:

$$\Phi(s) = \begin{bmatrix} \frac{s+3}{(s+1)(s+2)} & \frac{2}{(s+1)(s+2)} \\ \frac{-1}{(s+1)(s+2)} & \frac{s}{(s+1)(s+2)} \end{bmatrix} = \begin{bmatrix} \frac{2}{s+1} - \frac{1}{s+2} & \frac{2}{s+1} - \frac{2}{s+2} \\ \frac{-1}{s+1} + \frac{1}{s+2} & \frac{-1}{s+1} + \frac{2}{s+2} \end{bmatrix}$$

$$e^{\mathbf{A}t} = \mathcal{L}^{-1}(\Phi(s)) = \begin{bmatrix} 2e^{-t} - e^{-2t} & 2e^{-t} - 2e^{-2t} \\ -e^{-t} + e^{-2t} & -e^{-t} + 2e^{-2t} \end{bmatrix}$$

$$e^{\mathbf{A}t}\mathbf{x}(0) = \begin{bmatrix} 4e^{-t} - 2e^{-2t} + 2e^{-t} - 2e^{-2t} \\ -2e^{-t} + 2e^{-2t} - e^{-t} + 2e^{-2t} \end{bmatrix} = \begin{bmatrix} 6e^{-t} - 4e^{-2t} \\ -3e^{-t} + 4e^{-2t} \end{bmatrix}$$

Also:  $\mathbf{B}\mathbf{f}(t) = \begin{bmatrix} 0 \\ 1 \end{bmatrix} \times 0 = 0$

hence:  $\mathbf{x}(t) = \begin{bmatrix} (6e^{-t} - 4e^{-2t})u(t) \\ (-3e^{-t} + 4e^{-2t})u(t) \end{bmatrix}$

which is the same thing as in Prob. 13.3-1.

13.3-12 From Prob. 13.3-2,

$$\Phi(s) = \begin{bmatrix} \frac{s}{(s+2)(s+3)} & \frac{-6}{(s+2)(s+3)} \\ \frac{1}{(s+2)(s+3)} & \frac{s+5}{(s+2)(s+3)} \end{bmatrix} = \begin{bmatrix} \frac{-2}{s+2} + \frac{3}{s+3} & \frac{-6}{s+2} + \frac{6}{s+3} \\ \frac{1}{s+2} - \frac{1}{s+3} & \frac{3}{s+2} - \frac{2}{s+3} \end{bmatrix}$$

Hence:  $e^{\mathbf{A}t} = \mathcal{L}^{-1}(\Phi(s)) = \begin{bmatrix} -2e^{-2t} + 3e^{-3t} & -6e^{-2t} + 6e^{-3t} \\ e^{-2t} - e^{-3t} & 3e^{-2t} - 2e^{-3t} \end{bmatrix}$

And:

$$e^{\mathbf{A}t}\mathbf{x}(0) = \begin{bmatrix} -10e^{-2t} + 15e^{-3t} - 24e^{-2t} + 24e^{-3t} \\ 5e^{-2t} - 5e^{-3t} + 12e^{-2t} - 8e^{-3t} \end{bmatrix} = \begin{bmatrix} -34e^{-2t} + 39e^{-3t} \\ 17e^{-2t} - 13e^{-3t} \end{bmatrix}$$

Also:  $\mathbf{B}\mathbf{f}(t) = \begin{bmatrix} 1 \\ 0 \end{bmatrix} \sin 100t = \begin{bmatrix} \sin 100t \\ 0 \end{bmatrix}$

And  $e^{\mathbf{A}t} * \mathbf{B}\mathbf{f}(t) = \begin{bmatrix} -2e^{-2t} * \sin 100t + 3e^{-3t} * \sin 100t \\ e^{-2t} * \sin 100t - e^{-3t} * \sin 100t \end{bmatrix}$

$$= \begin{bmatrix} -\frac{2e^{-2t}}{100} + \frac{2\cos 100t}{100} + \frac{3e^{-3t}}{100} - \frac{3\cos 100t}{100} \\ + \frac{e^{-2t}}{100} - \frac{\cos 100t}{100} - \frac{e^{-3t}}{100} + \frac{\cos 100t}{100} \end{bmatrix}$$

$$= \begin{bmatrix} -0.02e^{-2t} + 0.03e^{-3t} - 0.01\cos 100t \\ 0.01e^{-2t} - 0.01e^{-3t} \end{bmatrix}$$

Hence:

$$\mathbf{x}(t) = e^{\mathbf{A}t}[\mathbf{x}(0)] + e^{\mathbf{A}t} * \mathbf{B}\mathbf{f}(t) = \begin{bmatrix} -34.02e^{-2t} + 39e^{-3t} + 0.01\cos 100t \\ 17.01e^{-2t} - 13.0e^{-3t} \end{bmatrix}$$

Hence

$$\mathbf{x}(t) = e^{\mathbf{A}t}\mathbf{x}(0) + e^{\mathbf{A}t} * \mathbf{B}f = \begin{bmatrix} -34.02e^{-2t} + 39.03e^{-3t} + 0.01 \cos 100t \\ 17.01e^{-2t} - 13.01e^{-3t} \end{bmatrix}$$

This is the same result as in Prob. 13.3-2.

**13.3-13** From Prob. 13.3-3,

$$\Phi(s) = \begin{bmatrix} \frac{1}{s+2} & 0 \\ \frac{1}{(s+1)(s+2)} & \frac{1}{s+1} \end{bmatrix} = \begin{bmatrix} \frac{1}{s+2} & 0 \\ \frac{1}{s+1} - \frac{1}{s+2} & \frac{1}{s+1} \end{bmatrix}$$

$$\text{Hence: } e^{\mathbf{A}t} = \mathcal{L}^{-1}(\Phi(s)) = \begin{bmatrix} e^{-2t} & 0 \\ e^{-t} - e^{-2t} & e^{-t} \end{bmatrix}$$

$$\text{And: } e^{\mathbf{A}t}\mathbf{x}(0) = \begin{bmatrix} e^{-2t} & 0 \\ e^{-t} - e^{-2t} & e^{-t} \end{bmatrix} \begin{bmatrix} 0 \\ -1 \end{bmatrix} = \begin{bmatrix} 0 \\ -e^{-t} \end{bmatrix}$$

$$\text{Also: } \mathbf{B}f(t) = \begin{bmatrix} 1 \\ 0 \end{bmatrix} u(t) = \begin{bmatrix} u(t) \\ 0 \end{bmatrix}$$

$$\text{And: } e^{\mathbf{A}t} * \mathbf{B}f(t) = \begin{bmatrix} e^{-2t} * u(t) \\ e^{-t} * u(t) - e^{-2t} * u(t) \end{bmatrix} = \begin{bmatrix} \frac{1}{2}(1 - e^{-2t})u(t) \\ (1 - e^{-t}) - \frac{1}{2}(1 - e^{-2t}) \end{bmatrix}$$

And hence:

$$\begin{aligned} \mathbf{x}(t) &= e^{\mathbf{A}t}\mathbf{x}(0) + e^{\mathbf{A}t} * \mathbf{B}f(t) = \begin{bmatrix} 0 \\ -e^{-t} \end{bmatrix} + \begin{bmatrix} \frac{1}{2} - \frac{1}{2}e^{-2t} \\ \frac{1}{2} - e^{-t} + \frac{1}{2}e^{-2t} \end{bmatrix} \\ &= \begin{bmatrix} \frac{1}{2} - \frac{1}{2}e^{-2t} \\ \frac{1}{2} + \frac{1}{2}e^{-2t} - 2e^{-t} \end{bmatrix} \end{aligned}$$

**13.3-14** From Prob. 13.3-4,

$$\Phi(s) = \begin{bmatrix} \frac{1}{s+1} & \frac{1}{(s+1)(s+2)} \\ 0 & \frac{1}{s+2} \end{bmatrix} = \begin{bmatrix} \frac{1}{s+1} & \frac{1}{s+1} - \frac{1}{s+2} \\ 0 & \frac{1}{s+2} \end{bmatrix}$$

$$\text{Hence: } e^{\mathbf{A}t} = \mathcal{L}^{-1}(\Phi(s)) = \begin{bmatrix} e^{-t} & e^{-t} - e^{-2t} \\ 0 & e^{-2t} \end{bmatrix}$$

$$e^{\mathbf{A}t}\mathbf{x}(0) = \begin{bmatrix} e^{-t} & e^{-t} - e^{-2t} \\ 0 & e^{-2t} \end{bmatrix} \begin{bmatrix} 1 \\ 2 \end{bmatrix} = \begin{bmatrix} 3e^{-t} - 2e^{-2t} \\ 2e^{-2t} \end{bmatrix}$$

$$\mathbf{B}f(t) = \begin{bmatrix} 1 & 1 \\ 0 & 1 \end{bmatrix} \begin{bmatrix} u(t) \\ \delta(t) \end{bmatrix} = \begin{bmatrix} u(t) + \delta(t) \\ \delta(t) \end{bmatrix}$$

$$\text{And } e^{\mathbf{A}t} * \mathbf{B}f(t) = \begin{bmatrix} e^{-t} * u(t) + e^{-t} * \delta(t) + e^{-t} * \delta(t) - e^{-2t} * \delta(t) \\ e^{-2t} * \delta(t) \end{bmatrix}$$

$$e^{\mathbf{A}t} * \mathbf{B}f(t) = \begin{bmatrix} (1 - e^{-t}) + e^{-t} + e^{-t} - e^{-2t} \\ e^{-2t} \end{bmatrix} \begin{bmatrix} 1 + e^{-t} - e^{-2t} \\ e^{-2t} \end{bmatrix}$$

$$\begin{aligned} \text{And hence: } \mathbf{x}(t) &= e^{\mathbf{A}t}\mathbf{x}(0) + e^{\mathbf{A}t} * \mathbf{B}f(t) = \begin{bmatrix} 3e^{-t} - 2e^{-2t} + 1 + e^{-t} - e^{-2t} \\ 2e^{-2t} + e^{-2t} \end{bmatrix} \\ &= \begin{bmatrix} 1 + 4e^{-t} - 3e^{-2t} \\ 3e^{-2t} \end{bmatrix} \end{aligned}$$

**13.3-15** From Prob. 13.3-5,

$$\Phi(s) = \begin{bmatrix} \frac{s}{(s+1)(s+2)} & \frac{1}{(s+1)(s+2)} \\ \frac{-2}{(s+1)(s+2)} & \frac{s+3}{(s+1)(s+2)} \end{bmatrix} = \begin{bmatrix} \frac{-1}{s+1} + \frac{2}{s+2} & \frac{1}{s+1} - \frac{1}{s+2} \\ \frac{-2}{s+1} + \frac{2}{s+2} & \frac{2}{s+1} - \frac{1}{s+2} \end{bmatrix}$$

And  $y(t)$  is given by:  $y(t) = \mathbf{C}[e^{\mathbf{A}t}\mathbf{x}(0) + e^{\mathbf{A}t}\mathbf{B} * f(t)] + \mathbf{D}f(t)$

$$\text{where: } e^{\mathbf{A}t} = \mathcal{L}^{-1}(\Phi(s)) = \begin{bmatrix} -e^{-t} + 2e^{-2t} & e^{-t} - e^{-2t} \\ -2e^{-t} + 2e^{-2t} & 2e^{-t} - e^{-2t} \end{bmatrix}$$

$$\text{And: } e^{\mathbf{A}t}\mathbf{x}(0) = e^{\mathbf{A}t} \begin{bmatrix} 2 \\ 0 \end{bmatrix} = \begin{bmatrix} -2e^{-t} + 4e^{-2t} \\ -2e^{-t} + 4e^{-2t} \end{bmatrix}$$

$$e^{\mathbf{A}t}\mathbf{B} = e^{\mathbf{A}t} \begin{bmatrix} 1 \\ 0 \end{bmatrix} = \begin{bmatrix} -e^{-t} + 2e^{-2t} \\ -2e^{-t} + 2e^{-2t} \end{bmatrix}$$

$$\begin{aligned} e^{\mathbf{A}t} * \mathbf{B}f(t) &= \begin{bmatrix} -e^{-t} + 2e^{-2t} \\ -2e^{-t} + 2e^{-2t} \end{bmatrix} * u(t) = \begin{bmatrix} -e^{-t} * u(t) + e^{-2t} * u(t) \\ -2e^{-t} * u(t) + 2e^{-2t} * u(t) \end{bmatrix} \\ &= \begin{bmatrix} e^{-t} - e^{-2t} \\ -1 + 2e^{-t} - e^{-2t} \end{bmatrix} \end{aligned}$$

Since  $\mathbf{D} = 0 \implies y(t) = \mathbf{C}[e^{\mathbf{A}t}\mathbf{x}(0) + e^{\mathbf{A}t} * \mathbf{B}f(t)]$

$$\begin{aligned} \text{And: } e^{\mathbf{A}t}\mathbf{x}(0) + e^{\mathbf{A}t} * \mathbf{B}f(t) &= \begin{bmatrix} -2e^{-t} + 4e^{-2t} \\ -4e^{-t} + 4e^{-2t} \end{bmatrix} + \begin{bmatrix} e^{-t} - e^{-2t} \\ -1 + 2e^{-t} - e^{-2t} \end{bmatrix} \\ &= \begin{bmatrix} -e^{-t} + 3e^{-2t} \\ -1 - 2e^{-t} + 3e^{-2t} \end{bmatrix} \end{aligned}$$

And hence:

$$y(t) = [0 \quad 1] + \begin{bmatrix} -e^{-t} + 3e^{-2t} \\ -1 - 2e^{-t} + 3e^{-2t} \end{bmatrix} = (-1 - 2e^{-t} + 3e^{-2t})u(t)$$

### 13.3-16

$$y(t) = \mathbf{C}[e^{\mathbf{A}t}\mathbf{x}(0) + e^{\mathbf{A}t} * \mathbf{B}f(t)] + \mathbf{D}f(t)$$

From Prob. 13.3-6 we have obtained:

$$\Phi(s) = \begin{bmatrix} \frac{s+1}{(s+1)^2+1} & \frac{1}{(s+1)^2+1} \\ \frac{-1}{(s+1)^2+1} & \frac{s+1}{(s+1)^2+1} \end{bmatrix}$$

$$\text{Hence: } e^{\mathbf{A}t} = \mathcal{L}^{-1}(\Phi(s)) = \begin{bmatrix} e^{-t} \cos t & e^{-t} \sin t \\ -e^{-t} \sin t & e^{-t} \cos t \end{bmatrix}$$

$$e^{\mathbf{A}t}\mathbf{x}(0) = e^{\mathbf{A}t} \begin{bmatrix} 2 \\ 1 \end{bmatrix} = \begin{bmatrix} 2e^{-t} \cos t + e^{-t} \sin t \\ -2e^{-t} \sin t + e^{-t} \cos t \end{bmatrix}$$

$$\text{And: } e^{\mathbf{A}t}\mathbf{B} = e^{\mathbf{A}t} \begin{bmatrix} 0 \\ 1 \end{bmatrix} = \begin{bmatrix} e^{-t} \sin t \\ e^{-t} \cos t \end{bmatrix}$$

$$\text{And: } e^{\mathbf{A}t} * \mathbf{B}f(t) = \begin{bmatrix} e^{-t} \sin t * u(t) \\ e^{-t} \cos t * u(t) \end{bmatrix} = \begin{bmatrix} \frac{\cos(\frac{\pi}{2}-\phi)}{\sqrt{2}} - \frac{e^{-t}}{\sqrt{2}} \cos(t - \frac{\pi}{2} - \phi) \\ \frac{\cos(-\phi)}{\sqrt{2}} - \frac{e^{-t}}{\sqrt{2}} \cos(t - \phi) \end{bmatrix}$$

where:  $\phi = \tan^{-1} \frac{-1}{1} = -\frac{\pi}{4}$ . And hence:

$$e^{\mathbf{A}t}\mathbf{x}(0) + e^{\mathbf{A}t} * \mathbf{B}f(t) = \begin{bmatrix} \frac{1}{2} + \frac{3}{2}e^{-t} \cos t + \frac{1}{2}e^{-t} \sin t \\ \frac{1}{2} + \frac{1}{2}e^{-t} \cos t - \frac{3}{2}e^{-t} \sin t \end{bmatrix}$$

And

$$\begin{aligned} y(t) &= \mathbf{C}[e^{\mathbf{A}t}\mathbf{x}(0) + e^{\mathbf{A}t} * \mathbf{B}\mathbf{f}(t)] + \mathbf{D}\mathbf{f}(t) \\ &= [1 \quad 1][e^{\mathbf{A}t}\mathbf{x}(0) + e^{\mathbf{A}t} * \mathbf{B}\mathbf{f}(t)] + \dot{u}(t) \\ &= [1 + 2e^{-t} \cos t - e^{-t} \sin t + 1]u(t) = [2 + 2e^{-t} \cos t - e^{-t} \sin t]u(t) \end{aligned}$$

13.3-17

$$H(s) = \frac{3s + 10}{s^2 + 7s + 12}$$

From Eq. (13.65) we have:

$$\mathbf{h}(t) = \mathbf{C}\phi(t)\mathbf{B} + \mathbf{D}\delta(t) \quad \text{where} \quad \phi(t) = e^{\mathbf{A}t}$$

From Prob. 13.3-7 we obtained  $\Phi(s)$  as:

$$\Phi(s) = \begin{bmatrix} \frac{1}{s+4} & \frac{1}{(s+3)(s+4)} \\ 0 & \frac{1}{s+1} \end{bmatrix} \quad \mathbf{B} = \begin{bmatrix} 3 \\ 1 \end{bmatrix} \quad \mathbf{C} = [1 \quad 0] \quad \text{and} \quad \mathbf{D} = 0$$

$$\text{hence:} \quad e^{\mathbf{A}t} = \mathcal{L}^{-1}(\Phi(s)) = \begin{bmatrix} e^{-4t} & e^{-3t} - e^{-4t} \\ 0 & e^{-3t} \end{bmatrix}$$

$$\text{And:} \quad \phi(t)\mathbf{B} = \begin{bmatrix} 3e^{-4t} + e^{-3t} - e^{-4t} \\ e^{-3t} \end{bmatrix} = \begin{bmatrix} e^{-3t} + 2e^{-4t} \\ e^{-3t} \end{bmatrix}$$

$$\begin{aligned} \text{Since} \quad \mathbf{D} = 0, \quad h(t) &= \mathbf{C}\phi(t)\mathbf{B} = [1 \quad 0]\phi(t)\mathbf{B} \\ &= (e^{-3t} + 2e^{-4t})u(t) \end{aligned}$$

13.3-18 From Prob. 13.3-6.

$$\Phi(s) = \begin{bmatrix} \frac{s+1}{(s+1)^2+1} & \frac{1}{(s+1)^2+1} \\ \frac{-1}{(s+1)^2+1} & \frac{s+1}{(s+1)^2+1} \end{bmatrix}$$

$$\text{hence:} \quad \phi(t) = \mathcal{L}^{-1}(\Phi(s)) = \begin{bmatrix} e^{-t} \cos t & e^{-t} \sin t \\ -e^{-t} \sin t & e^{-t} \cos t \end{bmatrix}$$

$$\phi(t)\mathbf{B} = \phi(t) \begin{bmatrix} 0 \\ 1 \end{bmatrix} = \begin{bmatrix} e^{-t} \sin t \\ e^{-t} \cos t \end{bmatrix}$$

$$\text{And:} \quad \mathbf{C}\phi(t)\mathbf{B} = [1 \quad 1]\phi(t)\mathbf{B} = (e^{-t} \sin t + e^{-t} \cos t)$$

And

$$h(t) = \mathbf{C}\phi(t)\mathbf{B} + \delta(t) = \delta(t) + (e^{-t} \sin t + e^{-t} \cos t)u(t)$$

13.3-19 From Prob. 13.3-10,

$$\phi(s) = \begin{bmatrix} \frac{2s+1}{(s+1)^2} & \frac{s}{(s+1)^2} \\ \frac{4+s}{(s+1)^2} & \frac{4s+7}{(s+1)^2} \end{bmatrix} = \begin{bmatrix} \frac{2}{s+1} - \frac{1}{(s+1)^2} & \frac{1}{s+1} - \frac{1}{(s+1)^2} \\ \frac{1}{s+1} + \frac{3}{(s+1)^2} & \frac{4}{s+1} + \frac{3}{(s+1)^2} \end{bmatrix}$$

And hence: the unit inputs response  $\mathbf{h}(t)$  is given by:

$$\mathbf{h}(t) = \mathcal{L}^{-1}\{\mathbf{H}(s)\} = \begin{bmatrix} 2e^{-t} - te^{-t} & e^{-t} - te^{-t} \\ e^{-t} + 3te^{-t} & 4e^{-t} + 3te^{-t} \\ \delta(t) + e^{-t} & e^{-t} \end{bmatrix}$$

## 13.4-1

$$\begin{bmatrix} \dot{x}_1 \\ \dot{x}_2 \end{bmatrix} = \begin{bmatrix} 0 & 1 \\ -1 & -1 \end{bmatrix} \begin{bmatrix} x_1 \\ x_2 \end{bmatrix} + \begin{bmatrix} 2 \\ 1 \end{bmatrix} f$$

$$\mathbf{w} = \begin{bmatrix} 0 & 1 \\ -1 & 1 \end{bmatrix} \begin{bmatrix} x_1 \\ x_2 \end{bmatrix} = \mathbf{P}\mathbf{x}$$

The new state equation of the system is given by:

$$\dot{\mathbf{w}} = \mathbf{P}\mathbf{A}\mathbf{P}^{-1}\mathbf{w} + \mathbf{P}\mathbf{B} = \hat{\mathbf{A}}\mathbf{w} + \hat{\mathbf{B}}f$$

$$\mathbf{P}^{-1} = \begin{bmatrix} 1 & -1 \\ 1 & 0 \end{bmatrix} \Rightarrow \mathbf{P}\mathbf{A} = \begin{bmatrix} 0 & 1 \\ -1 & 1 \end{bmatrix} \begin{bmatrix} 0 & 1 \\ -1 & -1 \end{bmatrix} = \begin{bmatrix} -1 & -1 \\ -1 & -2 \end{bmatrix}$$

$$\mathbf{P}\mathbf{A}\mathbf{P}^{-1} = \begin{bmatrix} -1 & -1 \\ -1 & -2 \end{bmatrix} \begin{bmatrix} 1 & -1 \\ 1 & 0 \end{bmatrix} = \begin{bmatrix} -2 & 1 \\ -3 & 1 \end{bmatrix}$$

$$\text{And: } \mathbf{P}\mathbf{B} = \begin{bmatrix} 0 & 1 \\ -1 & 1 \end{bmatrix} \begin{bmatrix} 2 \\ 1 \end{bmatrix} = \begin{bmatrix} 1 \\ -1 \end{bmatrix} f$$

$$\text{Hence } \begin{bmatrix} \dot{w}_1 \\ \dot{w}_2 \end{bmatrix} = \begin{bmatrix} -2 & 1 \\ -3 & 1 \end{bmatrix} \begin{bmatrix} w_1 \\ w_2 \end{bmatrix} + \begin{bmatrix} 1 \\ -1 \end{bmatrix} f$$

Eigenvalues in the original system:

The eigenvalues are the roots of the characteristic equation, thus: in the original system:

$$|s\mathbf{I} - \mathbf{A}| = \begin{vmatrix} s & -1 \\ 1 & s+1 \end{vmatrix} = (s+1)s + 1 = s^2 + s + 1 = 0$$

$$\text{The roots are given by: } s_{1,2} = \frac{-1 \pm j\sqrt{3}}{2}$$

In the transformed system, the characteristic equation is given by:

$$|s\mathbf{I} - \hat{\mathbf{A}}| = \begin{vmatrix} s+2 & -1 \\ 3 & s-1 \end{vmatrix} = (s+2)(s-1) + 3 = s^2 - s + 2s - 2 + 3 = s^2 + s + 1$$

And the eigenvalues are given by:

$$s_{1,2} = \frac{-1 \pm j\sqrt{3}}{2}$$

which are the same as in the original system.

## 13.4-2

$$\begin{bmatrix} \dot{x}_1 \\ \dot{x}_2 \end{bmatrix} = \begin{bmatrix} 0 & 1 \\ -2 & -3 \end{bmatrix} \begin{bmatrix} x_1 \\ x_2 \end{bmatrix} + \begin{bmatrix} 0 \\ 2 \end{bmatrix} f(t)$$

(a) The characteristic equation is given by:

$$|s\mathbf{I} - \mathbf{A}| = 0 = \begin{vmatrix} s & -1 \\ 2 & s+3 \end{vmatrix} = s(s+3) - 2 = s^2 + 3s + 2 = (s+1)(s+2) = 0$$

$\lambda_1 = -1$  and  $\lambda_2 = -2$  are the eigenvalues. And

$$\Lambda = \begin{bmatrix} -1 & 0 \\ 0 & -2 \end{bmatrix}$$

$\mathbf{w} = \mathbf{P}\mathbf{x}$  and  $\dot{\mathbf{w}} = \mathbf{P}\mathbf{A}\mathbf{P}^{-1}\mathbf{w} + \mathbf{P}\mathbf{B}f = \Lambda\mathbf{w} + \hat{\mathbf{B}}f$

Hence we have to find  $\mathbf{P}$  such that:  $\mathbf{P}\mathbf{A}\mathbf{P}^{-1} = \Lambda$  or  $\Lambda\mathbf{P} = \mathbf{P}\mathbf{A}$

$$\begin{bmatrix} -1 & 0 \\ 0 & -2 \end{bmatrix} \begin{bmatrix} p_{11} & p_{12} \\ p_{21} & p_{22} \end{bmatrix} = \begin{bmatrix} p_{11} & p_{12} \\ p_{21} & p_{22} \end{bmatrix} \begin{bmatrix} 0 & 1 \\ -2 & -3 \end{bmatrix}$$

$$\left. \begin{array}{l} -p_{11} = 2p_{12} \implies p_{11} = 2p_{12} \\ p_{12} = 3p_{12} - p_{11} \\ p_{21} = p_{22} \\ p_{22} = 3p_{22} - p_{21} \end{array} \right\} \implies \begin{array}{l} p_{12} = 3p_{12} - 2p_{12} \\ \text{If we choose } p_{11} = 2 \text{ then } p_{12} = 1 \\ \text{And if } p_{21} = 1 \text{ then } p_{22} = 1 \end{array}$$

Therefore 
$$\mathbf{P} = \begin{bmatrix} 2 & 1 \\ 1 & 1 \end{bmatrix}$$

and hence 
$$\mathbf{w} = \begin{bmatrix} w_1 \\ w_2 \end{bmatrix} = \begin{bmatrix} 2 & 1 \\ 1 & 1 \end{bmatrix} \begin{bmatrix} x_1 \\ x_2 \end{bmatrix} = \begin{bmatrix} 2x_1 + x_2 \\ x_1 + x_2 \end{bmatrix}$$

(b)  $\mathbf{y} = \mathbf{C}\mathbf{x} + \mathbf{D}f$  where  $\mathbf{D} = 0 \implies \mathbf{y} = \mathbf{C}\mathbf{x}$ .  
we have  $\mathbf{w} = \mathbf{P}\mathbf{x} \implies \mathbf{P}^{-1}\mathbf{w} = \mathbf{x} \implies \mathbf{y} = \mathbf{C}\mathbf{P}^{-1}\mathbf{w}$ . hence:

$$\mathbf{P}^{-1} = \begin{bmatrix} 1 & -1 \\ -1 & 2 \end{bmatrix}, \quad \mathbf{C}\mathbf{P}^{-1} = \begin{bmatrix} 1 & 1 \\ -1 & 2 \end{bmatrix} \begin{bmatrix} 1 & -1 \\ -1 & 2 \end{bmatrix} = \begin{bmatrix} 0 & 1 \\ -3 & 5 \end{bmatrix}$$

$$\mathbf{y} = \begin{bmatrix} 0 & 1 \\ -3 & 5 \end{bmatrix} \begin{bmatrix} w_1 \\ w_2 \end{bmatrix} = \begin{bmatrix} w_2 \\ 5w_2 - 3w_1 \end{bmatrix}$$

13.4-3

$$\dot{\mathbf{x}} = \begin{bmatrix} 0 & 1 & 0 \\ 0 & 0 & 1 \\ 0 & -2 & -3 \end{bmatrix} \mathbf{x} + \begin{bmatrix} 0 \\ 0 \\ 1 \end{bmatrix} f$$

The characteristic equation is given by:

$$\begin{aligned} |s\mathbf{I} - \mathbf{A}| &= \begin{vmatrix} s & -1 & 0 \\ 0 & s & -1 \\ 0 & 2 & s+3 \end{vmatrix} \\ &= s\{(s)(s+3) + 2\} = s(s^2 + 3s + 2) = s(s+1)(s+2) = 0 \end{aligned}$$

Hence the eigenvalues are:  $\lambda_1 = 0$ ,  $\lambda_2 = -1$  and  $\lambda_3 = -2$ . And

$$\Lambda = \begin{bmatrix} 0 & 0 & 0 \\ 0 & -1 & 0 \\ 0 & 0 & -2 \end{bmatrix}$$

In the transformed system we have:  $\mathbf{w} = \mathbf{P}\mathbf{x}$  and  $\dot{\mathbf{w}} = \mathbf{P}\mathbf{A}\mathbf{P}^{-1}\mathbf{w} + \mathbf{P}\mathbf{B}f$

We have to find  $\mathbf{P}$  such that:  $\mathbf{P}\mathbf{A}\mathbf{P}^{-1} = \Lambda$  or  $\Lambda\mathbf{P} = \mathbf{P}\mathbf{A}$ .

$$\begin{bmatrix} 0 & 0 & 0 \\ 0 & -1 & 0 \\ 0 & 0 & -2 \end{bmatrix} \begin{bmatrix} p_{11} & p_{12} & p_{13} \\ p_{21} & p_{22} & p_{23} \\ p_{31} & p_{32} & p_{33} \end{bmatrix} = \begin{bmatrix} p_{11} & p_{12} & p_{13} \\ p_{21} & p_{22} & p_{23} \\ p_{31} & p_{32} & p_{33} \end{bmatrix} \begin{bmatrix} 0 & 1 & 0 \\ 0 & 0 & 1 \\ 0 & -2 & -3 \end{bmatrix}$$

$$\implies \left\{ \begin{array}{l} p_{21} = 0 \quad p_{31} = 0 \quad \text{if } p_{11} = 2 \text{ then } p_{13} = 1 \text{ and } p_{12} = 3 \\ p_{11} = p_{13} \\ p_{12} = 3p_{13} \\ p_{22} = 2p_{23} - p_{21} \quad \text{if } p_{23} = 1, \text{ then } p_{22} = 2 \text{ and } p_{23} = 1 \\ p_{23} = 3p_{23} - p_{22} \quad \text{if } p_{32} = 1 \text{ then } p_{33} = 1 \\ 2p_{32} = 2p_{33} - p_{31} \\ 2p_{33} = 3p_{33} - p_{32} \implies p_{33} = p_{32} \end{array} \right.$$

13.4-4

$$\mathbf{w} = \mathbf{P}\mathbf{x} = \begin{bmatrix} 2 & 3 & 1 \\ 0 & 2 & 1 \\ 0 & 1 & 1 \end{bmatrix} \begin{bmatrix} x_1 \\ x_2 \\ x_3 \end{bmatrix} = \begin{bmatrix} w_1 \\ w_2 \\ w_3 \end{bmatrix}$$

$$y(t) = \mathbf{C}[e^{\mathbf{A}t}\mathbf{x}(0) + e^{\mathbf{A}t} * \mathbf{B}f(t)]$$

where:  $e^{\mathbf{A}t} = \mathcal{L}^{-1}(\phi(s))$

$$(\phi(s))^{-1} = [s\mathbf{I} - \mathbf{A}] = \begin{bmatrix} s+1 & 0 & 0 \\ 0 & s+3 & 0 \\ 0 & 0 & s+2 \end{bmatrix}$$

$$\phi(t) = (s\mathbf{I} - \mathbf{A})^{-1} = \begin{bmatrix} \frac{1}{s+1} & 0 & 0 \\ 0 & \frac{1}{s+3} & 0 \\ 0 & 0 & \frac{1}{s+2} \end{bmatrix} \text{ and } e^{\mathbf{A}t} = \begin{bmatrix} e^{-t} & 0 & 0 \\ 0 & e^{-3t} & 0 \\ 0 & 0 & e^{-2t} \end{bmatrix}$$

And:  $e^{\mathbf{A}t}\mathbf{x}(0) = e^{\mathbf{A}t} \begin{bmatrix} 1 \\ 2 \\ 1 \end{bmatrix} = \begin{bmatrix} e^{-t} \\ 2e^{-3t} \\ e^{-2t} \end{bmatrix}$

$$e^{\mathbf{A}t}\mathbf{B} = e^{\mathbf{A}t} \begin{bmatrix} 1 \\ 1 \\ 1 \end{bmatrix} = \begin{bmatrix} e^{-t} \\ e^{-3t} \\ e^{-2t} \end{bmatrix}$$

and:  $e^{\mathbf{A}t} * \mathbf{B}f(t) = e^{\mathbf{A}t} * \mathbf{B}u(t) = \begin{bmatrix} e^{-t} * u(t) \\ e^{-3t} * u(t) \\ e^{-2t} * u(t) \end{bmatrix} = \begin{bmatrix} (1 - e^{-t})u(t) \\ \frac{1}{3}(1 - e^{-3t})u(t) \\ \frac{1}{2}(1 - e^{-2t})u(t) \end{bmatrix}$

Hence:  $e^{\mathbf{A}t}\mathbf{x}(0) + e^{\mathbf{A}t} * \mathbf{B}f(t) = \begin{bmatrix} e^{-t} + 1 - e^{-t} \\ 2e^{-3t} + \frac{1}{3} - \frac{1}{3}e^{-3t} \\ e^{-2t} + \frac{1}{2} - \frac{1}{2}e^{-2t} \end{bmatrix} = \begin{bmatrix} 1 \\ \frac{1}{3} + \frac{5}{3}e^{-3t} \\ \frac{1}{2} + \frac{1}{2}e^{-2t} \end{bmatrix}$

And finally:  $y(t) = \mathbf{C}[e^{\mathbf{A}t}\mathbf{x}(0) + e^{\mathbf{A}t} * \mathbf{B}f(t)]$  with  $\mathbf{C} = [1 \ 3 \ 1]$

$$y(t) = \left(1 + 1 + 5e^{-3t} + \frac{1}{2} + \frac{1}{2}e^{-2t}\right) = \left(\frac{5}{2} + \frac{1}{2}e^{-2t} + 5e^{-3t}\right)$$

13.5-1 (a) state equations:

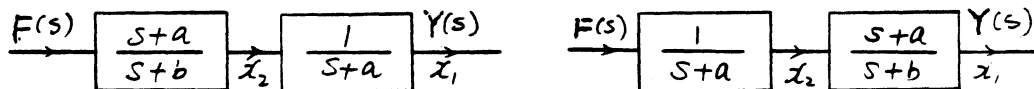

Fig. S13.5-1a and b

$$\dot{x}_2 + bx_2 = (a - b)f \Rightarrow \dot{x}_2 = -bx_2 + (a - b)f$$

$$\dot{x}_1 + ax_1 = x_2 + f \Rightarrow \dot{x}_1 = -ax_1 + x_2 + f$$

$$\begin{bmatrix} \dot{x}_1 \\ \dot{x}_2 \end{bmatrix} = \begin{bmatrix} -a & 1 \\ 0 & -b \end{bmatrix} \begin{bmatrix} x_1 \\ x_2 \end{bmatrix} + \begin{bmatrix} 1 \\ (a - b) \end{bmatrix} f$$

the output is:  $y = x_1 = [1 \ 0] \begin{bmatrix} x_1 \\ x_2 \end{bmatrix}$

The characteristic equation is

$$|s\mathbf{I} - \mathbf{A}| = 0 = \begin{vmatrix} s+a & -1 \\ 0 & s+b \end{vmatrix} = (s+a)(s+b) = 0$$

$\lambda_1 = -a$  and  $\lambda_2 = -b$  are the eigenvalues.

$$\Lambda = \begin{bmatrix} -a & 0 \\ 0 & -b \end{bmatrix}$$

we also have:  $\mathbf{w} = \mathbf{P}\mathbf{x}$  and  $\dot{\mathbf{w}} = \mathbf{P}\mathbf{A}\mathbf{P}^{-1}\mathbf{w} + \mathbf{P}\mathbf{B}f$ .

We are looking for  $\mathbf{P}$  such that:  $\mathbf{P}\mathbf{A}\mathbf{P}^{-1} = \Lambda$  or  $\Lambda\mathbf{P} = \mathbf{P}\mathbf{A}$

$$\begin{bmatrix} -a & 0 \\ 0 & -b \end{bmatrix} \begin{bmatrix} p_{11} & p_{12} \\ p_{21} & p_{22} \end{bmatrix} = \begin{bmatrix} p_{11} & p_{12} \\ p_{21} & p_{22} \end{bmatrix} \begin{bmatrix} -a & 1 \\ 0 & -b \end{bmatrix}$$

$$\Rightarrow \begin{cases} -ap_{11} = -ap_{11} & \text{If } p_{11} = (b-a) \text{ then } p_{12} = 1 \\ -bp_{21} = -ap_{21} \Rightarrow p_{21} = 0 & p_{21} = 0 \quad \text{and} \quad p_{22} \\ -ap_{12} = p_{11} - bp_{12} = 0 & \text{can be anything; let's take } p_{22} = 1 \\ -bp_{22} = p_{21} - bp_{22} \Rightarrow p_{21} = 0 \end{cases}$$

And thus:  $\mathbf{w} = \mathbf{P}\mathbf{x} = \begin{bmatrix} b-a & 1 \\ 0 & 1 \end{bmatrix} \begin{bmatrix} x_1 \\ x_2 \end{bmatrix}$

Observability: the output in terms of  $\mathbf{w}$  is:  $y = \mathbf{C}\mathbf{x} = \mathbf{C}\mathbf{P}^{-1}\mathbf{w} = \hat{\mathbf{C}}\mathbf{w}$ .

where:  $\mathbf{P}^{-1} = \frac{1}{b-a} \begin{bmatrix} 1 & -1 \\ 0 & b-a \end{bmatrix} = \begin{bmatrix} \frac{1}{b-a} & \frac{-1}{b-a} \\ 0 & 1 \end{bmatrix}$

hence:  $\hat{\mathbf{C}} = \mathbf{C}\mathbf{P}^{-1} = [1 \ 0] \begin{bmatrix} \frac{1}{b-a} & \frac{-1}{b-a} \\ 0 & 1 \end{bmatrix} = [\frac{1}{b-a} \ \frac{-1}{b-a}]$

We notice that in  $\hat{\mathbf{C}}$ , there is no column with all elements zeros, hence we conclude that the system is observable.

Controllability: In the new system (diagonalized form):

$$\hat{\mathbf{B}} = \mathbf{P}\mathbf{B} = \begin{bmatrix} b-a & 1 \\ 0 & 1 \end{bmatrix} \begin{bmatrix} 1 \\ a-b \end{bmatrix} = \begin{bmatrix} 0 \\ a-b \end{bmatrix}$$

the 1st row in  $\hat{\mathbf{B}}$  is zero. We affirm that this system is not controllable.

(b) State equations:

$$\begin{bmatrix} \dot{x}_1 \\ \dot{x}_2 \end{bmatrix} = \begin{bmatrix} -b & 0 \\ 0 & -a \end{bmatrix} \begin{bmatrix} x_1 \\ x_2 \end{bmatrix} + \begin{bmatrix} 1 \\ 1 \end{bmatrix} f$$

and:  $y = x_1 = [1 \ 0] \begin{bmatrix} x_1 \\ x_2 \end{bmatrix}$

The matrix  $\mathbf{A}$  is already in the diagonal form:

$$\mathbf{P} = \mathbf{A} = \begin{bmatrix} -b & 0 \\ 0 & -a \end{bmatrix} \Rightarrow \mathbf{P}^{-1} = \frac{1}{ab} \begin{bmatrix} -a & 0 \\ 0 & -b \end{bmatrix} = \begin{bmatrix} -\frac{1}{b} & 0 \\ 0 & -\frac{1}{a} \end{bmatrix}$$

In the transformed system:  $\dot{\mathbf{w}} = \mathbf{P}\mathbf{A}\mathbf{P}^{-1}\mathbf{w} + \mathbf{P}\mathbf{B}f = \mathbf{A}\mathbf{w} + \hat{\mathbf{B}}f$ .

Observability:

$$\hat{\mathbf{C}} = \mathbf{C}\mathbf{P}^{-1} = [1 \ 0] \begin{bmatrix} -\frac{1}{b} & 0 \\ 0 & -\frac{1}{a} \end{bmatrix} = [-\frac{1}{b} \ 0]$$



the second column in  $\hat{\mathbf{C}}$  vanishes. This system is not observable.  
Controllability:

$$\hat{\mathbf{B}} = \mathbf{P}\mathbf{B} = \begin{bmatrix} -b & 0 \\ 0 & -a \end{bmatrix} \begin{bmatrix} 1 & 1 \end{bmatrix} = \begin{bmatrix} -b & -a \end{bmatrix}$$

in  $\hat{\mathbf{B}}$ , there is no row with all elements zeros; hence this system is controllable.

13.6-1 (a) Time-domain method: the output  $y[k]$  is given by:

$$y[k] = \mathbf{C}\mathbf{A}^k\mathbf{x}[0] + \mathbf{C}\mathbf{A}^{k-1}u[k-1] * \mathbf{B}f[k] + \mathbf{D}f[k]$$

The characteristic equation of  $\mathbf{A}$  is:

$$|\lambda\mathbf{I} - \mathbf{A}| = \begin{vmatrix} \lambda - 2 & 0 \\ -1 & \lambda - 1 \end{vmatrix} = (\lambda - 1)(\lambda - 2) = 0$$

$\lambda_1 = 1$  and  $\lambda_2 = 2$  are the eigenvalues of  $\mathbf{A}$ . Also:

$$\mathbf{A}^k = \beta_0\mathbf{I} + \beta_1\mathbf{A} \quad \text{where:} \quad \begin{bmatrix} \beta_0 \\ \beta_1 \end{bmatrix} = \begin{bmatrix} 1 & 1 \\ 1 & 2 \end{bmatrix}^{-1} \begin{bmatrix} 1 \\ 2^k \end{bmatrix}$$

$$\begin{bmatrix} \beta_0 \\ \beta_1 \end{bmatrix} = \begin{bmatrix} 2 & -1 \\ -1 & 1 \end{bmatrix} \begin{bmatrix} 1 \\ 2^k \end{bmatrix} = \begin{bmatrix} 2 - 2^k \\ -1 + 2^k \end{bmatrix}$$

hence:

$$\mathbf{A}^k = \begin{bmatrix} \beta_0 & 0 \\ 0 & \beta_0 \end{bmatrix} + \begin{bmatrix} 2\beta_1 & 0 \\ \beta_1 & \beta_1 \end{bmatrix} = \begin{bmatrix} 2^k & 0 \\ 2^k - 1 & 1 \end{bmatrix}$$

$$\text{Hence:} \quad \mathbf{C}\mathbf{A}^k = \begin{bmatrix} 0 & 1 \end{bmatrix} \mathbf{A}^k = \begin{bmatrix} 2^k - 1 & 1 \end{bmatrix}$$

And:

$$y_z[k] = \mathbf{C}\mathbf{A}^k\mathbf{x}(0) = \mathbf{C}\mathbf{A}^k \begin{bmatrix} 2 \\ 1 \end{bmatrix} = (2^{k+1} - 1)u[k]$$

The zero-state component is given by:

$$y_f[k] = \mathbf{C}\mathbf{A}^{k-1}u[k-1] * \mathbf{B}f[k] + \mathbf{D}f[k]$$

But

$$\mathbf{C}\mathbf{A}^k u[k] * \mathbf{B}f[k] = \begin{bmatrix} 2^k - 1 & 1 \end{bmatrix} u[k] * \begin{bmatrix} 0 \\ u[k] \end{bmatrix} = (k+1)u[k]$$

Hence

$$y_f[k] = ku[k-1] + \mathbf{D}f[k] = ku[k-1] + u[k] = (k+1)u[k]$$

$$\text{and} \quad y[k] = y_z[k] + y_f[k] = [2^{k+1} + k]u[k]$$

(b) Frequency-domain method: in this case:

$$\mathbf{Y}(z) = \mathbf{C}(\mathbf{I} - z^{-1}\mathbf{A})^{-1}\mathbf{x}[0] + [\mathbf{C}(z\mathbf{I} - \mathbf{A})^{-1}\mathbf{B} + \mathbf{D}]F[z]$$

$$\begin{aligned} (\mathbf{I} - z^{-1}\mathbf{A})^{-1} &= \begin{bmatrix} 1 - 2z^{-1} & 0 \\ -z^{-1} & 1 - z^{-1} \end{bmatrix}^{-1} = \begin{bmatrix} 1 - \frac{2}{z} & 0 \\ -\frac{1}{z} & 1 - \frac{1}{z} \end{bmatrix}^{-1} = \begin{bmatrix} \frac{z-2}{z} & 0 \\ -\frac{1}{z} & \frac{z-1}{z} \end{bmatrix}^{-1} \\ &= \frac{z^2}{(z-1)(z-2)} \begin{bmatrix} \frac{z-1}{z} & 0 \\ \frac{1}{z} & \frac{z-2}{z} \end{bmatrix} = \begin{bmatrix} \frac{z}{z-2} & 0 \\ \frac{z}{(z-1)(z-2)} & \frac{z}{z-1} \end{bmatrix} \end{aligned}$$

Also:

$$(z\mathbf{I} - \mathbf{A})^{-1} = \begin{bmatrix} z-2 & 0 \\ -1 & z-1 \end{bmatrix}^{-1} = \frac{1}{(z-1)(z-2)} \begin{bmatrix} z-1 & 0 \\ 1 & z-2 \end{bmatrix}$$

$$= \begin{bmatrix} \frac{1}{z-2} & 0 \\ \frac{1}{(z-1)(z-2)} & \frac{1}{z-1} \end{bmatrix}$$

$$\text{and } \mathbf{C}(\mathbf{I} - z^{-1}\mathbf{A})^{-1} = \left[ \frac{z}{(z-1)(z-2)} \quad \frac{z}{z-1} \right]$$

$$\mathbf{C}(\mathbf{I} - z^{-1}\mathbf{A})^{-1}\mathbf{x}(0) = \left[ \frac{2z}{(z-1)(z-2)} + \frac{z}{z-1} \right] = \frac{z^2}{(z-1)(z-2)}$$

Also

$$\mathbf{C}(z\mathbf{I} - \mathbf{A})^{-1} = \left[ \frac{1}{(z-1)(z-2)} \quad \frac{1}{z-1} \right] \quad \text{and} \quad \mathbf{C}(z\mathbf{I} - \mathbf{A})^{-1}\mathbf{B} = \frac{1}{z-1}$$

$$\text{Hence: } \mathbf{C}(z\mathbf{I} - \mathbf{A})^{-1}\mathbf{B} + \mathbf{D} = \frac{1}{z-1} + \mathbf{D} = \frac{1}{z-1} + 1 = \frac{z}{z-1}$$

$$f[k] = u[k] \quad \text{and} \quad F(z) = \frac{z}{z-1}$$

$$\text{And hence: } (\mathbf{C}(z\mathbf{I} - \mathbf{A})^{-1}\mathbf{B} + \mathbf{D})F(z) = \left[ \frac{z}{z-1} \right]^2 = \frac{z^2}{(z-1)^2}$$

$$\mathbf{Y}(z) = \mathbf{C}(\mathbf{I} - z^{-1}\mathbf{A})^{-1}\mathbf{x}(0) + [\mathbf{C}(z\mathbf{I} - \mathbf{A})^{-1}\mathbf{B} + \mathbf{D}]F(z) = \frac{z^2}{(z-1)(z-2)} + \frac{z^2}{(z-1)^2}$$

$$\frac{\mathbf{Y}(z)}{z} = \frac{1}{z-2} + \frac{z}{(z-1)^2} = \frac{2}{z-2} + \frac{1}{(z-1)^2}$$

$$\mathbf{Y}(z) = \frac{2z}{z-2} + \frac{z}{(z-1)^2}$$

$$\text{and } y[k] = z^{-1}[\mathbf{Y}(z)] = [2^k + 1]u[k] + (k+1)u[k]$$

$$= [2^{k+1} + k]u[k]$$

### 13.6-2

$$y[k] = \frac{E + 0.32}{E^2 + E + 0.16} f[k]$$

(a) In this case:

$$H(z) = \frac{Y(z)}{F(z)} = \frac{z + 0.32}{z^2 + z + 0.16}$$

$$= \frac{z + 0.32}{(z + 0.2)(z + 0.8)} = \frac{0.2}{z + 0.2} + \frac{0.8}{z + 0.8}$$

(b) State and output equations for the controller canonical form: using the output of each delay as a state variable we get:

$$x_1[k+1] = x_2[k]$$

$$x_2[k+1] = -0.16x_1[k] - x_2[k] + f[k]$$

First canonical form:

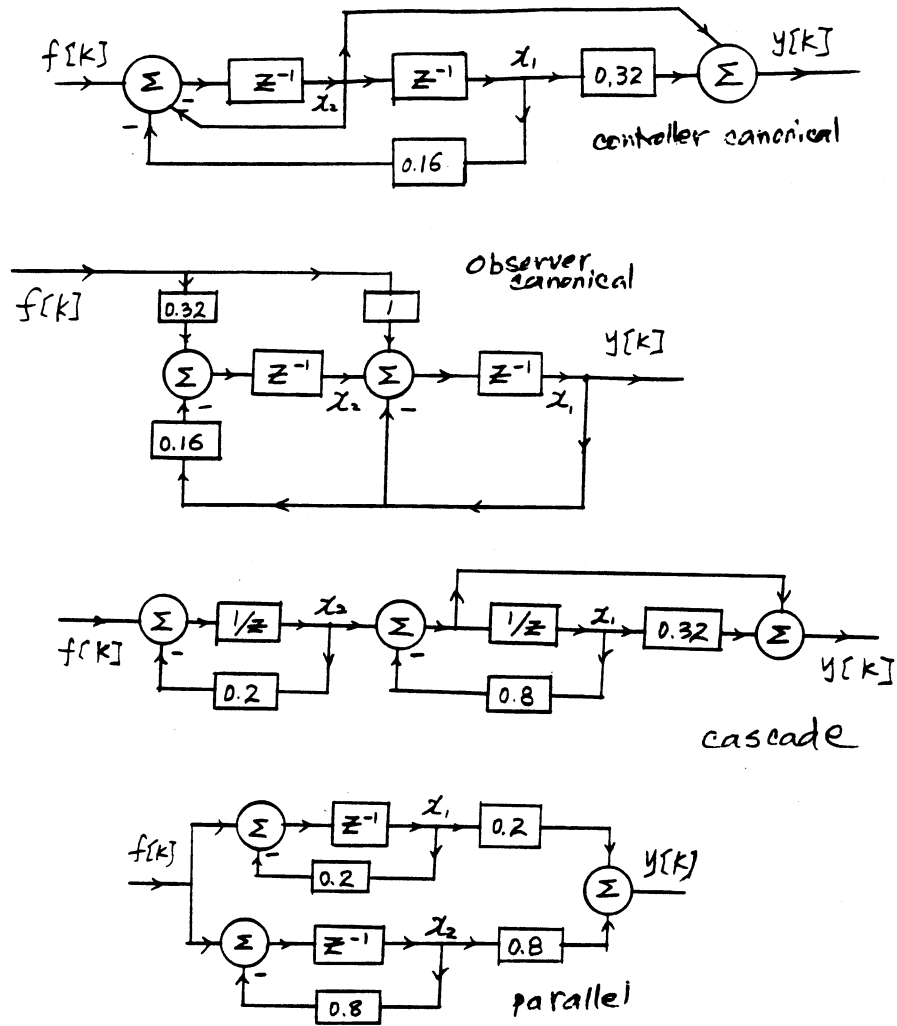

Figure S13.6-2

$$\begin{bmatrix} x_1[k+1] \\ x_2[k+1] \end{bmatrix} = \begin{bmatrix} 0 & 1 \\ -0.16 & -1 \end{bmatrix} \begin{bmatrix} x_1[k] \\ x_2[k] \end{bmatrix} + \begin{bmatrix} 0 \\ 1 \end{bmatrix} f[k]$$

output equation:

$$y[k] = 0.32x_1[k] + x_2[k] = \begin{bmatrix} 0.32 & 1 \end{bmatrix} \begin{bmatrix} x_1[k] \\ x_2[k] \end{bmatrix}$$

State equations for the observer canonical form:

$$x_1[k+1] = -x_1[k] + x_2[k] + f[k]$$

$$x_2[k+1] = -0.16x_1[k] + 0.32f[k]$$

$$\begin{bmatrix} x_1[k+1] \\ x_2[k+1] \end{bmatrix} = \begin{bmatrix} -1 & 1 \\ -0.16 & 0 \end{bmatrix} \begin{bmatrix} x_1[k] \\ x_2[k] \end{bmatrix} + \begin{bmatrix} 1 \\ 0.32 \end{bmatrix} f[k]$$

The output equation is:

$$y[k] = x_1[k] = \begin{bmatrix} 1 & 0 \end{bmatrix} \begin{bmatrix} x_1[k] \\ x_2[k] \end{bmatrix}$$

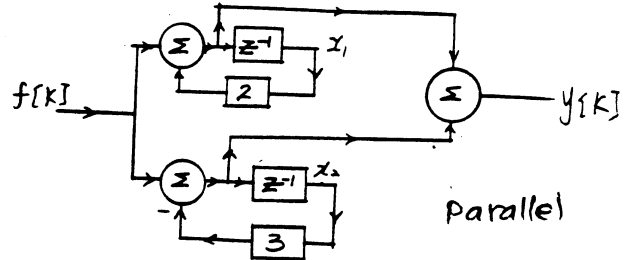
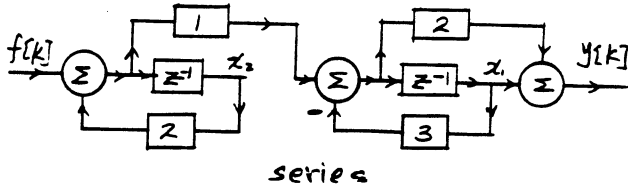
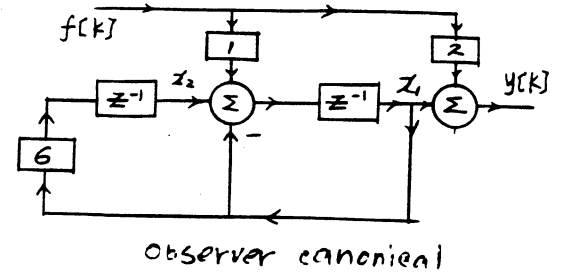
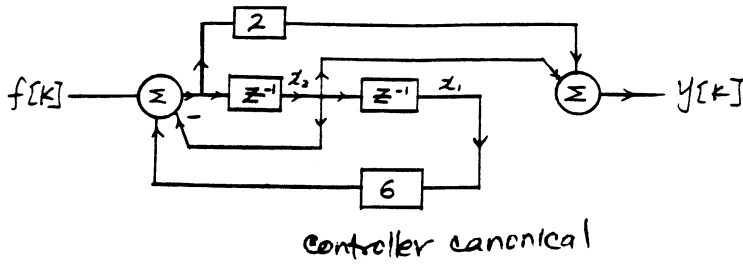

Figure S13.6-3

State equations for the cascade realization:

$$\begin{aligned} x_1[k+1] &= -0.8x_1[k] + x_2[k] \\ x_2[k+1] &= -0.2x_2[k] + f[k] \end{aligned}$$

$$\begin{bmatrix} x_1[k+1] \\ x_2[k+1] \end{bmatrix} = \begin{bmatrix} -0.8 & 1 \\ 0 & -0.2 \end{bmatrix} \begin{bmatrix} x_1[k] \\ x_2[k] \end{bmatrix} + \begin{bmatrix} 0 \\ 1 \end{bmatrix} f[k]$$

The output equation is:

$$y[k] = 0.32x_1[k] - 0.8x_1[k] + x_2[k] = \begin{bmatrix} -0.48 & 1 \end{bmatrix} \begin{bmatrix} x_1[k] \\ x_2[k] \end{bmatrix}$$

State equations for the parallel realization:

$$\begin{aligned} x_1[k+1] &= -0.2x_1[k] + f[k] \\ x_2[k+1] &= -0.8x_2[k] + f[k] \end{aligned}$$

$$\begin{bmatrix} x_1[k+1] \\ x_2[k+1] \end{bmatrix} = \begin{bmatrix} -0.2 & 0 \\ 0 & -0.8 \end{bmatrix} \begin{bmatrix} x_1[k] \\ x_2[k] \end{bmatrix} + \begin{bmatrix} 1 \\ 1 \end{bmatrix} f[k]$$

The output equation is:

$$y[k] = 0.2x_1[k] + 0.8x_2[k] = \begin{bmatrix} 0.2 & 0.8 \end{bmatrix} \begin{bmatrix} x_1[k] \\ x_2[k] \end{bmatrix}$$

13.6-3

$$y[k] = \frac{E(2E+1)}{E^2+E-6} f[k]$$

(a)

$$\begin{aligned} \frac{Y(z)}{F(z)} = H(z) &= \frac{z(2z+1)}{z^2+z-6} = \frac{2z^2+z}{z^2+z-6} \\ &= \frac{2z^2+z}{(z-2)(z+3)} = \left(\frac{z}{z-2}\right) \left(\frac{2z+1}{z+3}\right) \\ &= \frac{z}{z-2} + \frac{z}{z+3} \end{aligned}$$

(b) State and output equations for the controller canonical form:

$$x_1[k+1] = x_2[k]$$

$$x_2[k+1] = 6x_1[k] - x_2[k] + f[k]$$

and

$$\begin{bmatrix} x_1[k+1] \\ x_2[k+1] \end{bmatrix} = \begin{bmatrix} 0 & 1 \\ 6 & -1 \end{bmatrix} \begin{bmatrix} x_1[k] \\ x_2[k] \end{bmatrix} + \begin{bmatrix} 0 \\ 1 \end{bmatrix} f[k]$$

The output equation is:

$$\begin{aligned} y[k] &= x_2[k] + 2[6x_1[k] - x_2[k] + f[k]] \\ &= 12x_1[k] - 2x_2[k] + 2f[k] \end{aligned}$$

$$\text{Hence } y[k] = [12 \quad -2] \begin{bmatrix} x_1[k] \\ x_2[k] \end{bmatrix} + 2f[k]$$

State equations for the observer canonical form:

$$x_1[k+1] = -x_1[k] + x_2[k] + f[k]$$

$$x_2[k+1] = 6x_1[k]$$

$$\begin{bmatrix} x_1[k+1] \\ x_2[k+1] \end{bmatrix} = \begin{bmatrix} -1 & 1 \\ 6 & 0 \end{bmatrix} \begin{bmatrix} x_1[k] \\ x_2[k] \end{bmatrix} + \begin{bmatrix} 1 \\ 0 \end{bmatrix} f[k]$$

The output equation is:

$$y[k] = x_1[k] + 2f[k] = [1 \quad 0] \begin{bmatrix} x_1[k] \\ x_2[k] \end{bmatrix} + 2f[k]$$

State equations for the cascade realization:

$$x_1[k+1] = -0.3x_1[k] + 2x_2[k] + f[k]$$

$$x_2[k+1] = 2x_2[k] + f[k]$$

$$\begin{bmatrix} x_1[k+1] \\ x_2[k+1] \end{bmatrix} = \begin{bmatrix} -3 & 2 \\ 0 & 2 \end{bmatrix} \begin{bmatrix} x_1[k] \\ x_2[k] \end{bmatrix} + \begin{bmatrix} 1 \\ 1 \end{bmatrix} f[k]$$

The output equation is:

$$\begin{aligned} y[k] &= x_1[k] - 6x_1[k] + 4x_2[k] + 2f[k] \\ &= -5x_1[k] + 4x_2[k] + 2f[k] = [-5 \quad 4] \begin{bmatrix} x_1[k] \\ x_2[k] \end{bmatrix} + 2f[k] \end{aligned}$$

State equations for the parallel realization:

$$x_1[k+1] = 2x_1[k] + f[k]$$

$$x_2[k+1] = -3x_2[k] + f[k]$$

$$\begin{bmatrix} x_1[k+1] \\ x_2[k+1] \end{bmatrix} = \begin{bmatrix} 2 & 0 \\ 0 & -3 \end{bmatrix} \begin{bmatrix} x_1[k] \\ x_2[k] \end{bmatrix} + \begin{bmatrix} 1 \\ 1 \end{bmatrix} f[k]$$

The output equation is:

$$y[k] = 2x_1[k] + f[k] + f[k] - 3x_2[k]$$

$$y[k] = [2 \quad -3] \begin{bmatrix} x_1[k] \\ x_2[k] \end{bmatrix} + 2f[k]$$